

PINTI *buffet*
MADE IN ITALY

CALEIDO

-
2018

PINTI *buffet*
MADE IN ITALY

CALEIDO

-

2018

PINTI BUFFET CALEIDO.....	5
SCEGLIE COMPONENTI / Choose and compose.....	6
I CALDI / Heated.....	9
I FREDDI / Refrigerating systems.....	17
INEUTRI / Neutral.....	35
LE BASI A PONTE / Display Bridge Base.....	51
IDISTRIBUTORI / Dispensers.....	57
PERSONALIZZAZIONE / Personalization.....	67
RICAMBI/ Spare Parts.....	69
GASTRONORM.....	70
NOTE INFORMATIVE / Technical Information.....	71

CALEIDO

Caleido è la nuova linea di buffet progettata e realizzata da **Pinti Inox** per la ristorazione moderna, caratterizzata da:

COMPLETEZZA DI GAMMA

La linea è composta da 10 basi perfettamente abbinabili tra loro, in grado di soddisfare tutte le esigenze, dal grande hotel al piccolo ristorante.

VERSATILITÀ

Ogni articolo è composto da una base in acciaio e da una parte strutturale con misure Gastronorm: ciò garantisce un altissimo grado di personalizzazione e la massima intercambiabilità delle strutture per i vari momenti della giornata, dalla prima colazione alla cena.

DESIGN MINIMAL

La semplicità delle forme rende la linea Caleido adatta sia a contesti classici, eleganti e formali, sia a location moderne e di tendenza.

COLORE

Quattro i colori delle basi disponibili: **Salvia, Burro, Caffè, Carbone.**

Trovate l'acciaio troppo freddo? È possibile personalizzare i propri articoli inserendo bacinelle in porcellana bianca.

ROBUSTEZZA

Le strutture sono realizzate in acciaio inox verniciato a polvere, adatte a un utilizzo intensivo, anche all'aperto.

PERSONALIZZAZIONE

State cercando qualcosa di diverso? Richiedete un preventivo per personalizzare la Vostra sala con il colore e la composizione che avete in mente (per maggiori informazioni, vedete pag. 67)

Caleido is the new buffet line designed and manufactured by **Pinti Inox** following the modern catering trends asking for colour options, mix of materials and technical performance

WIDE RANGE

This product line includes 10 bases that can be combined together to meet the needs of big hotels and small independent restaurants

VERSATILITY

Each item is composed of a stainless steel base and a functional part following gastronorm standards. This make the buffet modular and easily adaptable to the different meals of the day from breakfast to dinner since the same base can be used with several functional parts

MINIMAL DESIGN

The pure, neutral and minimal shape of the metal frames, makes Caleido buffet line suitable for all kind of location, from classic to modern

COLOUR

The metal bases are available in 4 different colours: **Sage, Cream, Coffee, Coal.**

Do you think the plain stainless steel is a bit too cold? Just add some porcelain trays on your gastronorm basin.

STRENGTH

All the structures are made of powder coated stainless steel, resistant to an intensive but also to an outdoor use.

PERSONALIZATION













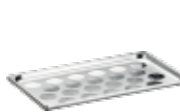

Are you looking for something different? Ask for a quote to personalize your room with the color and the composition you are thinking about (for additional information, have a look to page 67).

SCEGLI E COMPONI

Choose and compose

Cosa state cercando? Scegliete le parti funzionali nelle varie sezioni del catalogo (Caldi, Freddi, Neutri, Basi a Ponte e Distributori), quindi abbinatetele alle basi del colore che preferite.

What are you looking for? You can choose the functional components in the specific sections of our catalogue (Hot, Cold, Neutral, Display Bridge Base and Distributors) and then combine them to your favorite bases.

PARTI FUNZ. Functional parts BASI Stands	 F180555	 F180556	 F1800950	 F1802900	 F1803100	 F1803300	 F1802830	 F1802820	 F1802840
 518_0001			✓	✓	✓	✓	✓	✓	
 518_0002									✓
 518_0003	✓	✓							
 518_0004			✓		✓				
 518_0006									
 518_0007									

✓ I CALDI / Heated

✓ I FREDDI / Refrigerating systems

✓ I NEUTRI / Neutral

 F1802600	 F1806900	 F1807000	 F1806800	 F1800940	 F1800920	 F1803200	 F1805413	 F1805420	 F1809527
	✓	✓	✓	✓	✓	✓			
✓									
		✓			✓	✓			
							✓	✓	
									✓



PINTI *buffet*

CALEIDO

-

I CALDI

Heated

Les Articles Chauffés

Warmhaltesysteme

Sistemas Calientes



Bethell
MADE IN ITALY

LA PARTE FUNZIONALE



Cod. F11805555 - **Euro 272,58**

CHAFING DISH

High stand with steel border - Base haute avec protection en acier - Hoher Sockel mit Edelstahlrand - Base alta con plancha super.

COMPOSIZIONE:

Cod. D05B5559

1 VASCA BAGNOMARIA 1/1 h 110
Gastronorm bain marie basin - Bac de bain-marie GN - Wasserbad-Wanne GN - Recipiente baño-maría GN

Cod. D05B5558

1 COPERCHIO GN C/ POMOLO
GN lid with knob - Couvercle GN avec pommeau et - Gastronorm deckel mit Knopf - Tapa gastronómica GN con pomo

Cod. 5BA11065

1 BACINELLA GN 1/1 h 65
Gastronorm basin - Bac gastronorm - Durchbrochener basis - Cubeta gastronómica

Cod. 97200078

2 FORNELLETTI INOX
Stainless steel burner holder - Fourneau - Kocher - Quemadores

OPTIONAL:

IL CHAFING DISH È PREDISPOSTO PER L'INSERIMENTO DELLA RESISTENZA ELETTRICA CON REGOLATORE

Cod. 97150118 - **Euro 227,12**

230 Volt 700 Watt

The chafing dish can use a heater.

LE BASI



Cod. 518A0003 - **Euro 226,00**

BASE ALTA SALVIA h cm 20

High stand sage - Base haute vert - Hoher Sockel Salvia - Base alta verte



Cod. 518B0003 - **Euro 226,00**

BASE ALTA BURRO h cm 20

High stand cream - Base haute crème - Hoher Sockel Burro - Base altar crema



Cod. 518C0003 - **Euro 226,00**

BASE ALTA CAFFÈ h cm 20

High stand coffe - Base haute brun - Hoher Sockel Caffè - Base alta marron



Cod. 518D0003 - **Euro 226,00**

BASE ALTA CARBONE h cm 20

High stand coal - Base haute gris - Hoher Sockel Carbone - Base alta gris



CHAFING DISH RETTANGOLARE GN 1/1 CON CHIUSURA A FRIZIONE

Euro 498,58

GN complete rectangular chafing dish 1/1 friction closing.

Chafing Dish rectangulaire GN1/1 avec fermeture à friction.

Chafing Dish rechteckig GN 1/1 komplett mit Kupplungsschliessung.

Cubeta GN 1/1 con cierre con fricción.



PINTELLI
MADE IN ITALY

OPTIONAL

1/1

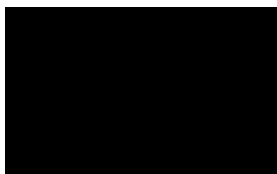

Cod. 97150785 - **Euro 124,12**
BACINELLA PORCELLANA 1/1 h cm 65
China basin 1/1 - Bac en porcelaine -
Porzellanschüssel - Cuenca de procelana



Cod. 97150786 - **Euro 65,10**
BACINELLA PORCELLANA 2/3 h cm 65
China basin 2/3 - Bac en porcelaine -
Porzellanschüssel - Cuenca de procelana

2/3



Cod. 97150787 - **Euro 45,78**
BACINELLA PORCELLANA 1/2 h cm 65
China basin 1/2 - Bac en porcelaine -
Porzellanschüssel - Cuenca de procelana



Cod. 97150788 - **Euro 32,46**
BACINELLA PORCELLANA 1/3 h cm 65
China basin 1/3 - Bac en porcelaine -
Porzellanschüssel - Cuenca de procelana

1/2

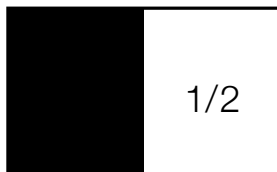

1/3

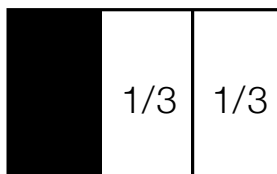



PINTELLI
MADE IN ITALY

PINTELLI

LA PARTE FUNZIONALE



Cod. F1805556 - **Euro 283,00**
ZUPPIERA RISCALDATA 2 STAZIONI
2 Heated soup bowls - Soupière a 2 stations -
Suppenstation - Sopera 2 staciones

COMPOSIZIONE:

Cod. D0595559
1 VASCA BAGNOMARIA 1/1
h 110 C/GANCI
Gastronorm bain marie basin - Bac de
bain-marie GN - Wasserbad-Wanne GN -
Recipiente baño-maría GN

Cod. 30595557
1 COPERCHIO PORTA ZUPPIERA GN
GN lid for soup bowl - Couvercle
pour soupière GN - Deckel für
Suppenschüsselhalter GN - Tapa porta-
sopera GN

Cod. 30597222
2 ZUPPIERE It 5 - Ø cm 22
Soup bowl - Soupière - Suppenschüssel -
Sopera

Cod. 30877522
2 COPERCHI ZUPPIERA Ø cm 22
Lid - Couvercle - Deckel - Tapa

Cod. 97200078
2 FORNELLETTI INOX
Stainless steel burner holder - Fourneau -
Kocher - Quemadores

OPTIONAL:

IL CHAFING DISH È PREDISPOSTO PER
L'INSERIMENTO DELLA RESISTENZA
ELETTRICA CON REGOLATORE
Cod. 97150118 - **Euro 227,12**
230 Volt 700 Watt
The chafing dish can use a heater.

LE BASI



Cod. 518A0003 - **Euro 226,00**
BASE ALTA SALVIA h cm 20
High stand sage - Base haute vert - Hoher
Sockel Salvia - Base alta verte



Cod. 518B0003 - **Euro 226,00**
BASE ALTA BURRO h cm 20
High stand cream - Base haute crème -
Hoher Sockel Burro - Base altar crema



Cod. 518C0003 - **Euro 226,00**
BASE ALTA CAFFÈ h cm 20
High stand coffe - Base haute brun - Hoher
Sockel Caffè - Base alta marron



Cod. 518D0003 - **Euro 226,00**
BASE ALTA CARBONE h cm 20
High stand coal - Base haute gris - Hoher
Sockel Carbone - Base alta gris



ZUPPIERA 2 STAZIONI RISCALDATA It 10

Euro 509,00

2 Heated soup bowls.

Soupière a 2 stations.

Suppenstation.

Sopera 2 staciones.



PINTI *buffet*

CALEIDO

-

I FREDDI

Refrigerating Systems

Les Articles Réfrigérés

Kühlsysteme

Sistemas Refrigerados



LA PARTE FUNZIONALE



Cod. F1800950 - **Euro 146,00**

VASSOIO PER AFFETTATI REFRIGERATO
Rectangular refrigerated tray with cover for sliced salami - Plateau rectangulaire réfrigérant avec cloche pour charcuterie. - Rechteckiges Tablett für gekühlten Aufschnitt mit Haube - Bandeja rectangular para fiambre en lonchas refrigerado con campana

COMPOSIZIONE:

Cod. 5BA11020
1 BACINELLA GN 1/1 h 20
Gastronorm basin
Bac gastronorm
Durchbrochener basis
Cubeta gastronormic

Cod. 5TI11040
1 TEGLIA GN 1/1 h 40
Gastronorm basin
Plat gastronorm
Durchbrochener blech
Fuente gastronormic

Cod. 5FP11000
1 FALSO FONDO FORATO PC 1/1
Perforated PC false bottom
Faux fond percé PC
Gelochter falscher Boden PC
Doble fondo perforado PC

Cod. 97150276
4 GEL PACK cm 20x9,8
Refrigerating brick
Briquelette réfrigérante
Kühlakku
Refrigerad

Cod. 97150856
1 CUPOLA RETT. APRIBILE PC
Rectangular dome lid
Cloche rectangulaire
Rolltop
Campana rectangular

LE BASI



Cod. 518A0001 - **Euro 150,00**
BASE BASSA SALVIA h cm 7,5
Low base sage - Base basse vert
Niedrigen Basis Salvia - Base baja verde



Cod. 518B0001 - **Euro 150,00**
BASE BASSA BURRO h cm 7,5
Low base cream - Base basse crème
Niedrigen Basis Burro - Base baja crema



Cod. 518C0001 - **Euro 150,00**
BASE BASSA CAFFÈ h cm 7,5
Low base coffee - Base basse brun
Niedrigen Basis Caffè - Base baja marron



Cod. 518D0001 - **Euro 150,00**
BASE BASSA CARBONE h cm 7,5
Low base coal - Base basse gris
Niedrigen Basis Carbone - Base baja gris



VASSOIO PER AFFETTATI REFRIGERATO

Euro 296,00

Rectangular refrigerated tray with cover for sliced salami.

Plateau rectangulaire réfrigérant avec cloche pour charcuterie.

Rechteckiges Tablett für gekühlten Aufschnitt mit Haube.

Bandeja rectangular para fiambre en lonchas refrigerado con campana.



Pasta

Pasta
MADE IN GERMANY

LA PARTE FUNZIONALE



Cod. F1802900 - **Euro 117,00**
 PORTA YOGURT FORATO (Ø cm 5,5) REFRIG.
 Refrigerated tray with 22 holes for yoghurt
 - Porte-yaourt réfrigérant à 22 trous
 - Joghurthalterschale, gekühlt mit 22
 Plätzen - Porta-yogur refrigerado con 22
 compartimentos

COMPOSIZIONE:

Cod. 5BP11065
 1 BACINELLA GN PC 1/1 h 65
 PC Gastronorm basin
 Bac gastronorm PC
 Durchbrochener basis PC
 Cubeta gastronómica PC

Cod. 5BFY1120
 1 BACINELLA FORATA
 PER PORTA YOGURT
 Perforated tray for yoghurt
 Plateau percé porte-yaourt
 Gelochte Joghurthalterschale
 Cuenco perforado para porta-yogurt

Cod. 5FP11000
 1 FALSO FONDO FORATO PC
 Perforated PC false bottom
 Faux fond percé PC
 Gelochter falscher Boden PC
 Doble fondo perforado PC

Cod. 97150276
 4 GEL PACK cm 20x9,8
 Refrigerating brick
 Briquette réfrigérante
 Kùhlakku
 Refrigerad



LE BASI



Cod. 518A0001 - **Euro 150,00**
 BASE BASSA SALVIA h cm 7,5
 Low base sage - Base basse vert
 Niedrigen Basis Salvia - Base baja verde



Cod. 518B0001 - **Euro 150,00**
 BASE BASSA BURRO h cm 7,5
 Low base cream - Base basse crème
 Niedrigen Basis Burro - Base baja crema



Cod. 518C0001 - **Euro 150,00**
 BASE BASSA CAFFÈ h cm 7,5
 Low base coffee - Base basse brun
 Niedrigen Basis Caffè - Base baja marron



Cod. 518D0001 - **Euro 150,00**
 BASE BASSA CARBONE h cm 7,5
 Low base coal - Base basse gris
 Niedrigen Basis Carbone - Base baja gris

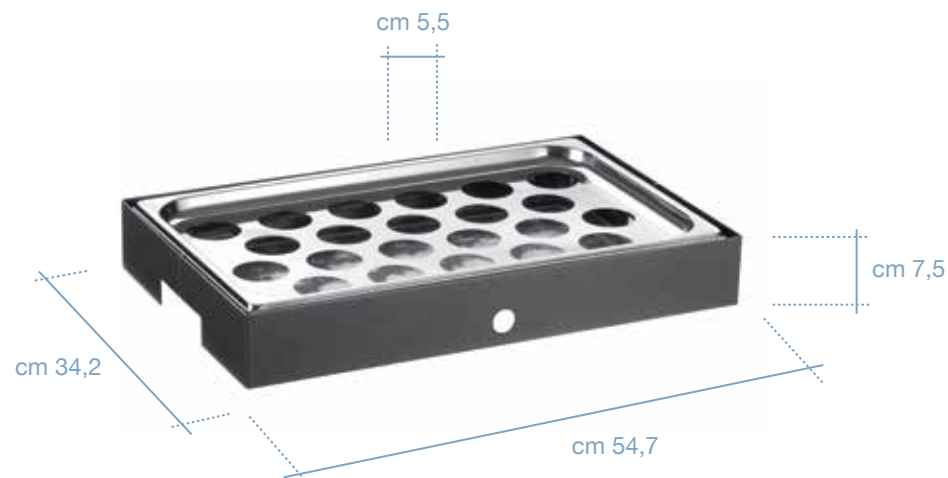

VASSOIO PORTA YOGURT REFRIGERATO (22 FORI Ø cm 5,5) **Euro 267,00**

Refrigerated tray with 22 holes for yoghurt.
 Porte-yaourt réfrigérant à 22 trous.
 Joghurthalterschale, gekühlt mit 22 Plätzen.
 Porta-yogur refrigerado con 22 compartimentos.



LA PARTE FUNZIONALE



Cod. F1803100 - **Euro 152,00**
PORTA BURRO E MARMELLATA REFRIG.
Perforated and refrigerated tray with cover for jam and butter - Plateau percé réfrigérant avec cloche pour beurre et confiture - Gelochtes Butter- und Marmelade-Tablett, gekühlt mit Haube - Bandeja perforada para mantequilla y mermelada refrigerada con campana

COMPOSIZIONE:

Cod. 5BA11040
1 BACINELLA GN 1/1 h 40
Gastronorm basin
Bac gastronorm
Durchbrochener basis
Cubeta gastronormic

Cod. F1133100
1 VASSOIO PORTABURRO FORATO
Perforated butter tray
Plateau percé pour beurre
Butter-Tablett
Mantequillera perforado

Cod. 5FP11000
1 FALSO FONDO FORATO PC 1/1
Perforated PC false bottom
Faux fond percé PC
Gelochter falscher Boden PC
Doble fondo perforado PC

Cod. 97150276
4 GEL PACK cm 20x9,8
Refrigerating brick
Briquette réfrigérante
Kühlakku
Refrigerad

Cod. 97150856
1 CUPOLA RETT. APRIBILE PC
Rectangular dome lid
Cloche rectangulaire
Rolltop
Campana rectangular

LE BASI



Cod. 518A0001 - **Euro 150,00**
BASE BASSA SALVIA h cm 7,5
Low base sage - Base basse vert
Niedrigen Basis Salvia - Base baja verde



Cod. 518B0001 - **Euro 150,00**
BASE BASSA BURRO h cm 7,5
Low base cream - Base basse crème
Niedrigen Basis Burro - Base baja crema



Cod. 518C0001 - **Euro 150,00**
BASE BASSA CAFFÈ h cm 7,5
Low base coffee - Base basse brun
Niedrigen Basis Caffè - Base baja marron



Cod. 518D0001 - **Euro 150,00**
BASE BASSA CARBONE h cm 7,5
Low base coal - Base basse gris
Niedrigen Basis Carbone - Base baja gris

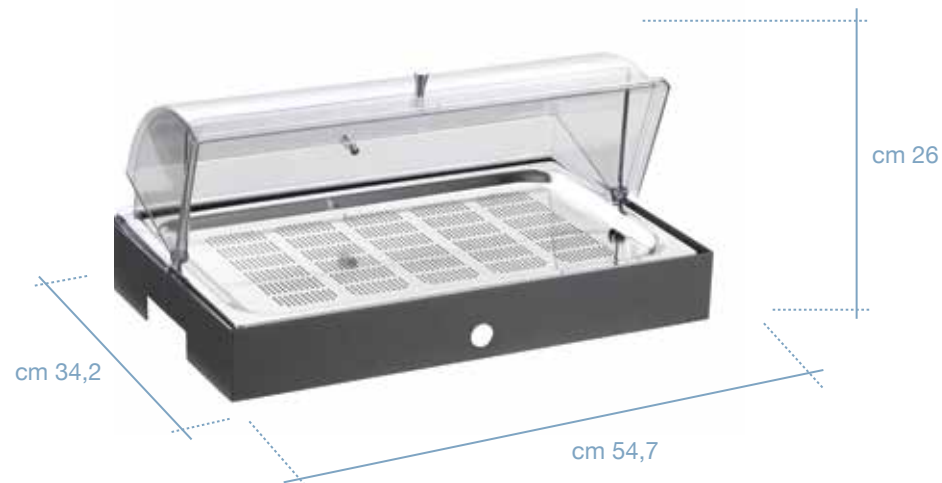

VASSOIO FORATO PORTA BURRO E MARMELLATA REFRIGERATO Euro 302,00

Perforated and refrigerated tray with cover for jam and butter.
Plateau percé réfrigérant avec cloche pour beurre et confiture.
Gelochtes Butter- und Marmelade-Tablett, gekühlt mit Haube.
Bandeja perforada para mantequilla y mermelada refrigerada con campana.



LA PARTE FUNZIONALE



Cod. F1803300 - **Euro 170,00**
PIASTRA ACCIAIO INOX REFRIGERATA
Refrigerated stainless steel plate - Plaque réfrigérée - Gekühlte Edelstahlplatte - Placa de acero refrigerada

COMPOSIZIONE:

Cod. 97150857
1 PIASTRA INOX GN 1/1
Refrigerated stainless steel plate
Plaque réfrigérée
Gekühlte Edelstahlplatte
Placa de acero

Cod. 5T111020
1 TEGLIA GN 1/1 h 20
Gastronorm basin
Plat gastronorm
Durchbrochener blech
Fuente gastronómico

Cod. 5FP11000
1 FALSO FONDO FORATO PC
Perforated PC false bottom
Faux fond percé PC
Gelochter falscher Boden PC - Doble fondo perforado PC

Cod. 97150276
4 GEL PACK cm 20x9,8
Refrigerating brick
Brique réfrigérante
Kühlakku
Refrigerad

Cod. 97150856
1 CUPOLA RETT. APRIBILE PC
Rectangular dome lid
Cloche rectangulaire
Rolltop
Campana rectangular

LE BASI



Cod. 518A0001 - **Euro 150,00**
BASE BASSA SALVIA h cm 7,5
Low base sage - Base basse vert
Niedrigen Basis Salvia - Base baja verde



Cod. 518B0001 - **Euro 150,00**
BASE BASSA BURRO h cm 7,5
Low base cream - Base basse crème
Niedrigen Basis Burro - Base baja crema



Cod. 518C0001 - **Euro 150,00**
BASE BASSA CAFFÈ h cm 7,5
Low base coffee - Base basse brun
Niedrigen Basis Caffè - Base baja marron



Cod. 518D0001 - **Euro 150,00**
BASE BASSA CARBONE h cm 7,5
Low base coal - Base basse gris
Niedrigen Basis Carbone - Base baja gris



PIASTRA ACCIAIO INOX REFRIGERATA

Euro 320,00

Refrigerated stainless steel plate.

Plateau rectangulaire réfrigérant avec cloche pour charcuterie.

Plaque réfrigérée en acier inox.

Placa de acero inoxidable refrigerada.



Pastille
MADE IN ITALY

LA PARTE FUNZIONALE



Cod. F1802830 - **Euro 142,00**
 PORTA UOVA E VERDURA REFRIGERATO
 Double wall refrigerated GN tray with cover for eggs and vegetables - Double plateau GN réfrigérant à double paroi avec cloche pour œufs et légumes - Doppeltes Eier- und Gemüsetablett GN, doppelwandig, gekühlt mit Haube - Bandeja doble GN porta-huevos y verduras con doble pared refrigerada con campana

COMPOSIZIONE:

Cod. FBAT1220
 1 VASSOIO PORTA UOVO GN 1/2
 Egg tray - Oeufrier - Eier-Tablett - Bandeja porta-huevos

Cod. 5BF12040
 1 BACINELLA GN 1/2 h 40 FORATA
 Perforated basin - Bac percé - Eier-Tablett - Cuenco perforado

Cod. 5BP12065
 2 BACINELLE GN PC 1/2 h 65
 PC Gastronorm basin - Bac gastronorm PC - Durchbrochener basis PC - Cubeta gastronómico PC

Cod. 5FP12000
 2 FALSI FONDI FORATI GN PC 1/2
 Perforated false bottom - Faux fond percé PC - Gelochter falscher Boden PC - Doble fondo perforado PC

Cod. 97150276
 4 GEL PACK cm 20x9,8
 Refrigerating brick - Briquette réfrigérante - Kühlakku - Refrigerad

Cod. 97150856
 1 CUPOLA RETT. APRIBILE PC
 Rectangular dome lid - Cloche rectangulaire - Rolltop - Campana rectangular



LE BASI



Cod. 518A0001 - **Euro 150,00**
 BASE BASSA SALVIA h cm 7,5
 Low base sage - Base basse vert
 Niedrigen Basis Salvia - Base baja verde



Cod. 518B0001 - **Euro 150,00**
 BASE BASSA BURRO h cm 7,5
 Low base cream - Base basse crème
 Niedrigen Basis Burro - Base baja crema



Cod. 518C0001 - **Euro 150,00**
 BASE BASSA CAFFÈ h cm 7,5
 Low base coffee - Base basse brun
 Niedrigen Basis Caffè - Base baja marron



Cod. 518D0001 - **Euro 150,00**
 BASE BASSA CARBONE h cm 7,5
 Low base coal - Base basse gris
 Niedrigen Basis Carbone - Base baja gris



VASSOIO PORTA UOVA E VERDURA REFRIGERATO **Euro 292,00**

Double wall refrigerated tray with cover for eggs and vegetables.
 Double plateau réfrigérant à double paroi avec cloche pour œufs et légumes.
 Doppeltes Eier- und Gemüsetablett, doppelwandig, gekühlt mit Haube.
 Bandeja doble porta-huevos y verduras con doble pared refrigerada con campana.



Pentti
MADE IN FINLAND

Pentti
MADE IN FINLAND

LA PARTE FUNZIONALE



Cod. F1802820 - **Euro 164,00**
 PORTA VERDURE 4 SCOMPARTI REFRIG.
 Refrigerated basin with cover for vegetables
 - Plateau légumes réfrigérant avec cloche
 - Gemüseschalenhalter, gekühlt mit Haube
 - Porta-verduras refrigerado con campana

COMPOSIZIONE:

Cod. 5BP11065
 1 BACINELLA GN PC 1/1 h 65
 Gastronorm basin
 Bac gastronorm
 Durchbrochener basis
 Cubeta gastronormic

Cod. 5BA28040
 4 BACINELLE GN 2/8 h 40
 Gastronorm basin
 Bac gastronorm
 Durchbrochener basis
 Cubeta gastronormic

Cod. 5FP11000
 1 FALSO FONDO GN PC 1/1
 h 65 FORATO
 PC Perforated false bottom
 Faux fond percé PC
 Gelochter falscher Boden PC
 Doble fondo perforado PC

Cod. 97150276
 4 GEL PACK cm 20x9,8
 Refrigerating brick
 Briquette réfrigérante
 Kühlakku
 Refrigerad

Cod. 97150856
 1 CUPOLA RETT. APRIBILE PC
 Rectangular dome lid
 Cloche rectangulaire
 Rolltop
 Campana rectangular



LE BASI



Cod. 518A0001 - **Euro 150,00**
 BASE BASSA SALVIA h cm 7,5
 Low base sage - Base basse vert
 Niedrigen Basis Salvia - Base baja verte



Cod. 518B0001 - **Euro 150,00**
 BASE BASSA BURRO h cm 7,5
 Low base cream - Base basse crème
 Niedrigen Basis Burro - Base baja crema



Cod. 518C0001 - **Euro 150,00**
 BASE BASSA CAFFÈ h cm 7,5
 Low base coffee - Base basse brun
 Niedrigen Basis Caffè - Base baja marron



Cod. 518D0001 - **Euro 150,00**
 BASE BASSA CARBONE h cm 7,5
 Low base coal - Base basse gris
 Niedrigen Basis Carbone - Base baja gris



VASSOIO PORTA VERDURE 4 SCOMPARTI REFRIGERATO Euro 314,00

Refrigerated basin with cover for vegetables.
 Plateau légumes réfrigérant avec cloche.
 Gemüseschalenhalter, gekühlt mit Haube.
 Porta-verduras refrigerado con campana.



LA PARTE FUNZIONALE



Cod. F1802840 - **Euro 167,00**
PORTA YOGURT E VERDURE REFRIG.
 Double wall refrigeret basin with cover for yoghurt and vegetables - Plateau réfrigérant double paroi avec cloche pour yaourt et légumes - Joghurt- und Gemüseschalenhalter, doppelwandig, gekühlt mit Haube - Porta-yogur y verduras con doble pared refrigerada con campana

COMPOSIZIONE:

Cod. D0595561
 1 VASCA BAGNOMARIA 1/1
 h 110 C/VITI
 Gastronorm bain marie basin
 Bac de bain-marie GN
 Wasserbad-Wanne GN
 Recipiente baño-maría GN

Cod. 5BP13100
 3 BACINELLE GN PC 1/3 h 100
 PC Gastronorm basin
 Bac gastronorm PC
 Durchbrochener basis PC
 Cubeta gastronómico PC

Cod. 5FF11000
 1 FALSO FONDO GN 1/1 FORATO
 Perforated false bottom
 Faux fond percé
 Gelochter falscher Boden
 Doble fondo perforado

Cod. 97150276
 4 GEL PACK cm 20x9,8
 Refrigerating brick
 Briquette réfrigérante
 Kühlakku
 Refrigererad

Cod. 97150856
 1 CUPOLA RETT. APRIBILE PC
 Rectangular dome lid
 Cloche rectangulaire
 Rolltop
 Campana rectangular



LE BASI



Cod. 518A0002 - **Euro 190,00**
BASE MEDIA SALVIA h cm 12,5
 Medium base sage - Base moyenne vert
 Mittelgroße Basis Salvia - Base média verte



Cod. 518B0002 - **Euro 190,00**
BASE MEDIA BURRO h cm 12,5
 Medium base cream - Base moyenne crème
 Mittelgroße Basis Burro - Base media crema



Cod. 518C0002 - **Euro 190,00**
BASE MEDIA CAFFÈ h cm 12,5
 Medium base coffee - Base moyenne brun
 Mittelgroße Basis Caffè - Base media marron



Cod. 518D0002 - **Euro 190,00**
BASE MEDIA CARBONE h cm 12,5
 Medium base coal - Base moyenne gris
 Mittelgroße Basis Carbone - Base média gris



VASSOIO PORTA YOGURT E VERDURE DOPPIA PARETE REFRIGERATO

Euro 357,00

Double wall refrigeret basin with cover for yoghurt and vegetables.
 Plateau réfrigérant double paroi avec cloche pour yaourt et légumes.
 Joghurt- und Gemüseschalenhalter, doppelwandig, gekühlt mit Haube.
 Porta-yogur y verduras con doble pared refrigerada con campana.



LA PARTE FUNZIONALE



Cod. F1802600 - **Euro 169,00**
VASCA GHIACCIO
Ice bucket - Bac à galcon - Eisbehälter-
Recipiente hielo

COMPOSIZIONE:

Cod. 30595559
1 VASCA CHAFING DISH 1/1 h 110
Chafing dish basin
Bac de chauffe-plats
Chafing Dish basis
Recipiente calentaplatos

Cod. 5TFC1140
1 TEGLIA FORATA PER
PORTA CHAMPAGNE
Perforated tray for champagne
Plateau rectangulaire pour champagne
Gelochtes Blech für Champagner-Kübel
Fuente perforada para porta-champagne

Cod. F1132600
2 PENTOLE PORTA
CHAMPAGNE It 7
Champagne pot
Bain-marie marmite pour champagne
Champagner-Kübel
Cubo porta-champagne

LE BASI



Cod. 518A0002 - **Euro 190,00**
BASE MEDIA SALVIA h cm 12,5
Medium base sage - Base moyenne vert
Mittelgroße Basis Salvia - Base média verte



Cod. 518B0002 - **Euro 190,00**
BASE MEDIA BURRO h cm 12,5
Medium base cream - Base moyenne crème
Mittelgroße Basis Burro - Base media crema



Cod. 518C0002 - **Euro 190,00**
BASE MEDIA CAFFÈ h cm 12,5
Medium base coffee - Base moyenne brun
Mittelgroße Basis Caffè - Base media marron



Cod. 518D0002 - **Euro 190,00**
BASE MEDIA CARBONE h cm 12,5
Medium base coal - Base moyenne gris
Mittelgroße Basis Carbone - Base média gris



VASCA GHIACCIO

Euro 359,00

Ice bucket.

Bac à glaçons.

Eisbehälter.

Recipiente hielo.



PINTI *buffet*

CALEIDO

-

I NEUTRI

Neutral

Les Articles Neutres

Neutral

Neutros



Piemonte
MADE IN ITALY

LA PARTE FUNZIONALE



Cod. F1806900 - **Euro 117,00**
CESTA PANE WENGE
 Wenge bread basket with cover - Corbeille à pain avec cloche - Brotkorb mit Haube - Cesto para el pan con campana



Cod. F1806700 - **Euro 117,00**
CESTA PANE PAGLIA
 Paille bread basket with cover - Corbeille à pain avec cloche - Brotkorb mit Haube - Cesto para el pan con campana

COMPOSIZIONE:

Cod. 5TI11040
 1 **TEGLIA 1/1 h 40**
 Gastronorm basin
 Plat gastronorm
 Durchbrochener blech
 Fuente gastronómico

Cod. L7150759
 1 **CESTA PANE WENGE C/FORCELLE**
 Wenge bread basket with hooks
 Corbeille a pain avec crochets
 Brotkorb mit Aufnahmegabeln für Haub
 Cesto para el pan con asas

Cod. L7150760
 1 **CESTA PANE PAGLIA C/FORCELLE**
 Paille bread basket with hooks
 Corbeille a pain avec crochets
 Brotkorb mit Aufnahmegabeln für Haub
 Cesto para el pan con asas

Cod. 97150856
 1 **CUPOLA RETT. APRIBILE PC**
 Rectangular dome lid- Cloche rectangulaire
 Rolltop - Campana rectangular

LE BASI



Cod. 518A0001 - **Euro 150,00**
BASE BASSA SALVIA h cm 7,5
 Low base sage - Base basse vert
 Niedrigen Basis Salvia - Base baja verde



Cod. 518B0001 - **Euro 150,00**
BASE BASSA BURRO h cm 7,5
 Low base cream - Base basse crème
 Niedrigen Basis Burro - Base baja crema



Cod. 518C0001 - **Euro 150,00**
BASE BASSA CAFFÈ h cm 7,5
 Low base coffee - Base basse brun
 Niedrigen Basis Caffè - Base baja marron



Cod. 518D0001 - **Euro 150,00**
BASE BASSA CARBONE h cm 7,5
 Low base coal - Base basse gris
 Niedrigen Basis Carbone - Base baja gris



CESTA PANE

Euro 267,00

Bread basket with cover.

Corbeille à pain avec cloche.

Brotkorb mit Haube.

Cesto para el pan con campana.



LA PARTE FUNZIONALE



Cod. F1807000 - **Euro 100,00**
CESTA PANE IN TESSUTO
Woven bread basket - Panièr pan en tissuts
- Brotkorb aus Stoff - Cesto para el pan de tejido

COMPOSIZIONE:

Cod. 5T111040
1 TEGLIA 1/1 h 40
Gastronorm basin
Plat gastronorm
Durchbrochener blech
Fuente gastronòmic

Cod. 97150860
1 CESTA PANE IN TESSUTO
Woven bread basket
Panièr pan en tissuts
Brotkorb aus Stoff
Cesto para el pan de tejido

Cod. 97150856
1 CUPOLA RETT. APRIBILE PC
Rectangular dome lid
Cloche rectangulaire
Rolltop
Campana rectangular

LE BASI



Cod. 518A0001 - **Euro 150,00**
BASE BASSA SALVIA h cm 7,5
Low base sage - Base basse vert
Niedrigen Basis Salvia - Base baja verte



Cod. 518B0001 - **Euro 150,00**
BASE BASSA BURRO h cm 7,5
Low base cream - Base basse crème
Niedrigen Basis Burro - Base baja crema



Cod. 518C0001 - **Euro 150,00**
BASE BASSA CAFFÈ h cm 7,5
Low base coffee - Base basse brun
Niedrigen Basis Caffè - Base baja marron



Cod. 518D0001 - **Euro 150,00**
BASE BASSA CARBONE h cm 7,5
Low base coal - Base basse gris
Niedrigen Basis Carbone - Base baja gris



CESTA PANE IN TESSUTO

Euro 250,00

Woven bread basket.

Panièr pain en tissuts.

Brotkorb aus Stoff.

Cesto para el pan de tejido.



LA PARTE FUNZIONALE



Cod. F1806800 - **Euro 99,00**
TAGLIERE PANE IN LEGNO
Bread board - Planche à couper le pain -
Brotschneidebrett in Nussbaumfarbe - Tabla
de cortar pan

COMPOSIZIONE:

Cod. 5T111020
1 TEGLIA GN 1/1 h 20
Gastronorm basin
Plat gastronorm
Durchbrochener blech
Fuente gastronómic

Cod. 97150859
2 TAGLIERE PANE
IN NOCE CANALETTO cm 27,5x34,5
"Canaletto" walnut bread chopping board
Coupe pain enuix "Canaletto"
Brotschneidebrett in Nussbaumfarbe
Tabla de noce de cortar pan



LE BASI



Cod. 518A0001 - **Euro 150,00**
BASE BASSA SALVIA h cm 7,5
Low base sage - Base basse vert
Niedrigen Basis Salvia - Base baja verte



Cod. 518B0001 - **Euro 150,00**
BASE BASSA BURRO h cm 7,5
Low base cream - Base basse crème
Niedrigen Basis Burro - Base baja crema



Cod. 518C0001 - **Euro 150,00**
BASE BASSA CAFFÈ h cm 7,5
Low base coffee - Base basse brun
Niedrigen Basis Caffè - Base baja marron



Cod. 518D0001 - **Euro 150,00**
BASE BASSA CARBONE h cm 7,5
Low base coal - Base basse gris
Niedrigen Basis Carbone - Base baja gris

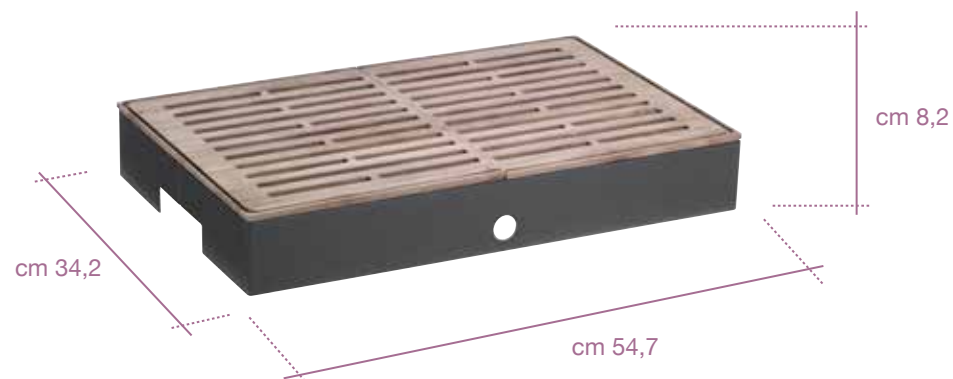

TAGLIERE PANE IN NOCE CANALETTO

Euro 249,00

"Canaletto" walnut bread chopping board.

Planche à couper le pain.

Scneidbrett.

Brotschneidebrett in Nussbaumfarbe.



PINTELLI

PINTELLI

LA PARTE FUNZIONALE



Cod. F1800940 - **Euro 150,00**

VASSOIO PER FORMAGGI

Rectangular cheese tray with non-deformable polypropilene board - Plateau à fromages avec planche à découper en polypropylène - Rechteckiges Kaesetablett 1/1 aus Polypropylen mit Rolltop, hoher Widerstand - Bandeja rectangular para queso con tabla de polipropileno

COMPOSIZIONE:

Cod. 97150858

1 TAGLIERE IN POLIPROPILENE

NERO cm 54,7x34,2

Polypropilene board

Hachoir en polypropylène

Küchenbrett aus Polypropylen

Tabla en polipropileno

Cod. 97150856

1 CUPOLA RETT. APRIBILE PC

Rectangular dome lid

Cloche rectangulaire

Rolltop

Campana rectangular

LE BASI



Cod. 518A0001 - **Euro 150,00**

BASE BASSA SALVIA h cm 7,5

Low base sage - Base basse vert

Niedrigen Basis Salvia - Base baja verde



Cod. 518B0001 - **Euro 150,00**

BASE BASSA BURRO h cm 7,5

Low base cream - Base basse crème

Niedrigen Basis Burro - Base baja crema



Cod. 518C0001 - **Euro 150,00**

BASE BASSA CAFFÈ h cm 7,5

Low base coffee - Base basse brun

Niedrigen Basis Caffè - Base baja marron



Cod. 518D0001 - **Euro 150,00**

BASE BASSA CARBONE h cm 7,5

Low base coal - Base basse gris

Niedrigen Basis Carbone - Base baja gris



VASSOIO PER FORMAGGI CON TAGLIERE IN POLIPROPILENE

Euro 300,00

Rectangular cheese tray with non-deformable polypropilene board.

Plateau à fromages avec planche à découper en polypropilène

Rechteckiges Kaesetablett aus Polypropylen mit Rolltop, hoher Widerstand.

Bandeja rectangular para queso con tabla de polipropileno.



Eveready
MADE IN CHINA

LA PARTE FUNZIONALE



Cod.F1800920 - **Euro 84,00**
VASSOIO PER PASTICCERIA
Rectangular tray with cover for pastries
- Plateau rectangulaire à pâtisserie -
Rechteckiges tablett 1/1 mit rolltop - Bandeja
rectangular para pastelería

COMPOSIZIONE:

Cod. 5BAF1120
1 BACINELLE GN 1/1 h 20
Gastronorm bain marie basin
Bac de bain-marie GN
Wasserbad-Wanne GN
Recipiente baño-maría GN

Cod. 97150856
1 CUPOLE RETT. APRIBILE PC
Rectangular dome lid
Cloche rectangulaire
Rolltop
Campana rectangular

LE BASI



Cod. 518A0001 - **Euro 150,00**
BASE BASSA SALVIA h cm 7,5
Low base sage - Base basse vert
Niedrigen Basis Salvia - Base baja verde



Cod. 518B0001 - **Euro 150,00**
BASE BASSA BURRO h cm 7,5
Low base cream - Base basse crème
Niedrigen Basis Burro - Base baja crema



Cod. 518C0001 - **Euro 150,00**
BASE BASSA CAFFÈ h cm 7,5
Low base coffee - Base basse brun
Niedrigen Basis Caffè - Base baja marron



Cod. 518D0001 - **Euro 150,00**
BASE BASSA CARBONE h cm 7,5
Low base coal - Base basse gris
Niedrigen Basis Carbone - Base baja gris

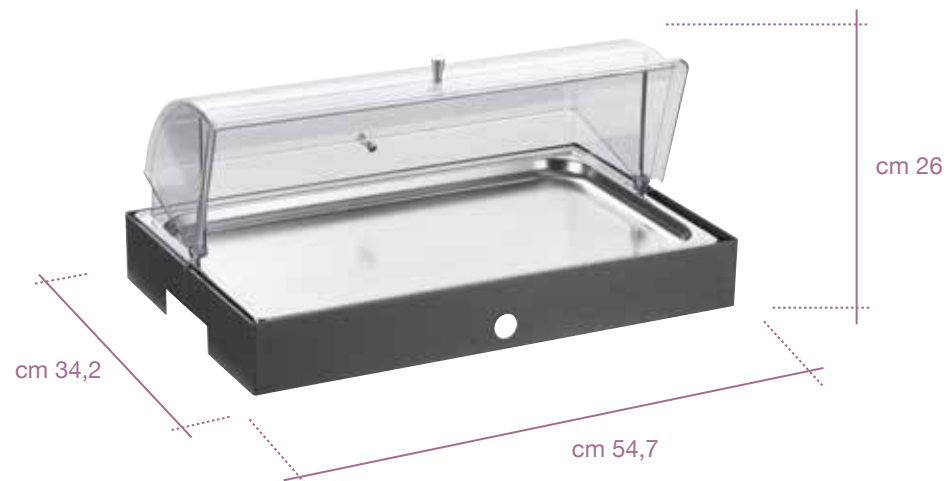

VASSOIO PASTICCERIA

Euro 234,00

Rectangular tray with cover for pastries.
Plateau rectangulaire à pâtisserie.
Rechteckiges tablett 1/1 mit rolltop.
Bandeja rectangular para pastelería.



LA PARTE FUNZIONALE



Cod. F1803200 - **Euro 79,00**
PORTA FRUTTA
Tray for fruit - Fruitier - Etagen-Obstschale -
Frutero

COMPOSIZIONE:

Cod. 5TIR1140
1 TEGLIA GN 1/1 h 40
C/RINGHIERE
GN tray with edges
Plat GN avec bords
Bain-marie deckel mit schlitze
Baño maria gastronomico



LE BASI



Cod. 518A0001 - **Euro 150,00**
BASE BASSA SALVIA h cm 7,5
Low base sage - Base basse vert
Niedrigen Basis Salvia - Base baja verte



Cod. 518B0001 - **Euro 150,00**
BASE BASSA BURRO h cm 7,5
Low base cream - Base basse crème
Niedrigen Basis Burro - Base baja crema



Cod. 518C0001 - **Euro 150,00**
BASE BASSA CAFFÈ h cm 7,5
Low base coffee - Base basse brun
Niedrigen Basis Caffè - Base baja marron



Cod. 518D0001 - **Euro 150,00**
BASE BASSA CARBONE h cm 7,5
Low base coal - Base basse gris
Niedrigen Basis Carbone - Base baja gris



PORTA FRUTTA

Euro 229,00

Tray for fruit.

Fruitier.

Etagen-Obstschale.

Frutero.



POSSIBILI COMBINAZIONI



BASE BASSA + ALZATA BASSA
Low base + low display bridge



BASE BASSA + ALZATA MEDIA
Low base + medium display bridge



BASE BASSA + ALZATA ALTA
Low base + high display bridge



BASE MEDIA + ALZATA MEDIA
Medium base + medium display bridge



Cod. 518A0008 - **Euro 150,00**
ALZATA ALTA SALVIA 57,5x17x30 h cm
High display bridge sage - Plateau haute vert
Hoher Etagerer Salvia - Pisos alta verte

Cod. 518A0009 - **Euro 120,00**
ALZATA MEDIA SALVIA 56,1x17x19,2 h cm
Medium display bridge sage - Plateau moyenne vert
Mittelgroße Etagerer Salvia - Pisos media verte

Cod. 518A0010 - **Euro 100,00**
ALZATA BASSA SALVIA 54,7x17x8,5 h cm
Low display bridge sage - Plateau basse vert
Niedrigen Etagerer Salvia - Pisos verte



Cod. 518C0008 - **Euro 150,00**
ALZATA ALTA CAFFÈ 57,5x17x30 h cm
High display bridge coffee - Plateau haute brun
Hoher Etagerer Caffè - Pisos alta marron

Cod. 518C0009 - **Euro 120,00**
ALZATA MEDIA CAFFÈ 56,1x17x19,2 h cm
Medium display bridge coffee - Plateau moyenne brun
Mittelgroße Etagerer Caffè - Pisos media marron

Cod. 518C0010 - **Euro 100,00**
ALZATA BASSA CAFFÈ 54,7x17x8,5 h cm
Low display bridge coffee - Plateau basse brun
Niedrigen Etagerer Caffè - Pisos marron



Cod. 518B0008 - **Euro 150,00**
ALZATA ALTA BURRO 57,5x17x30 h cm
High display bridge cream - Plateau haute crème
Hoher Etagerer Burro - Pisos alta crema

Cod. 518B0009 - **Euro 120,00**
ALZATA MEDIA BURRO 56,1x17x19,2 h cm
Medium display bridge cream - Plateau moyenne crème
Mittelgroße Etagerer Burro - Pisos media crema

Cod. 518B0010 - **Euro 100,00**
ALZATA BASSA BURRO 54,7x17x8,5 h cm
low display bridge cream Plateau basse crème
Niedrigen Etagerer Burro - Pisos crema



Cod. 518D0008 - **Euro 150,00**
ALZATA ALTA CARBONE 57,5x17x30 h cm
High display bridge coal - Plateau haute gris
Hoher Etagerer Carbone - Pisos alta gris

Cod. 518B0009 - **Euro 120,00**
ALZATA MEDIA CARBONE 56,1x17x19,2 h cm
Medium display bridge coal - Plateau moyenne gris
Mittelgroße Etagerer Carbone - Pisos media gris

Cod. 518D0010 - **Euro 100,00**
ALZATA BASSA CARBONE 54,7x17x8,5 h cm
Low display bridge coal - Plateau basse gris
Niedrigen Etagerer Carbone - Pisos gris



PINTI *buffet*

CALEIDO

-

LE BASI A PONTE

Display Bridge Base

Les Supports à Pont

Einsätze für Basis

Bandejas a Puente



Bxth
buffet
MADE IN ITALY

Bxth

BASI



Cod. 518A0004 - **Euro 220,00**
BASE A PONTE SALVIA h cm 37,8
Display Bridge base sage - Support
à pont vert - Etagere Salvia -
Bandejas a puente verde



Cod. 518B0004 - **Euro 220,00**
BASE A PONTE BURRO h cm 37,8
Display Bridge base cream -
Support à pont crème - Etagere
Burro - Bandejas a puente crema



Cod. 518C0004 - **Euro 220,00**
BASE A PONTE CAFFÈ h cm 37,8
Display Bridge base coffee -
Support à pont brun - Etagere Caffè
- Bandejas a puente marron



Cod. 518D0004 - **Euro 220,00**
BASE A PONTE CARBONE h cm 37,8
Display Bridge base coal - Support
à pont gris - Etagere Carbone -
Bandejas a puente gris

BASE A PONTE Display Bridge Base

POSSIBILI ALLESTIMENTI:

Possible combinations (with Display Bridge Base):



Cod. F1807000 - **Euro 100,00**
CESTA PANE IN TESSUTO
Woven bread basket

= Euro 320,00



Cod. F1803100 - **Euro 152,00**
PORTA BURRO E MARMELLATA REFRIG.
Perforated and refrigerated tray with cover
for jam and butter

= Euro 372,00



Cod. F1803200 - **Euro 79,00**
PORTA frutta
Tray for fruit

= Euro 299,00



Cod. F1800920 - **Euro 84,00**
VASSOIO PASTICCERIA
Refrigerated tray for pastries

= Euro 304,00



Cod. F1800950 - **Euro 146,00**
VASSOIO PER AFFETTATI REFRIGERATO
Refrigerated tray with cover for sliced salami

= Euro 366,00





ALZATE 2 PIANI

Double decker displays

TUTTE LE COMBINAZIONI PER ALZATA 2 PIANI
All the items that can be used under the display bridge base
to create a double decker display



VASSOIO PER AFFETTATI REFRIG.
Refrigerated tray for sliced salami



PORTA BURRO-MARMEL. REFRIG.
Refrigerated tray for jam and butter



PORTA VERDURE 4 SCOMP. REFR.
Refrigerated basin for vegetables



TAGLIERE PANE
Bread board



VASSOIO PASTICCERIA
Tray for pastries



PORTA YOGURT REFRIG.
Refrigerated tray with holes for yoghurt



PIASTRA ACCIAIO REFRIG.
Refrigerated stainless steel plate



PORTA UOVO-VERDURE REFRIG.
Refrigerated tray for eggs and vegetables



VASSOIO FORMAGGI
Cheese tray



PORTA FRUTTA
Tray for fruit



PINTI *buffet*

CALEIDO

-

I DISTRIBUTORI

Dispensers

Les Distributeurs

Spender

Distribuidores



LA PARTE FUNZIONALE



Cod. F1805413 - **Euro 160,00**
DISTRIBUTORE SUCCHI It 5
Juice and cold drink dispenser - Fontaine à jus de fruits simple paroi - Spender für Saft und kalte Getränke - Surtidor de zumos y bebidas con grifo Tomlinson

COMPOSIZIONE:

Cod. 97150863
1 CONTENITORE IN VETRO
CON RUBINETTO It 5
Juice dispenser with tap - Fontaine à jus de fruits avec robinet - Saftspender mit shahn - Surtidor de zumos con grifo

Cod. 97150865
1 VASCHETTA PER DISTRIB. SUCCHI
Juices bowl distributor - Petit bac pour fontaine à jus - Schale für Saftspender - Cubeta de surtidor de zumos

Cod. 97150866
1 COPERCHIO PER VASCHETTA
DISTR. SUCCHI
Lid for juices bowl distributor - Couvercle petit bac pour fontaine à jus - Deckel für Saftspender - Tapa por cubeta de surtidor de zumos

Cod. 97150867
1 GEL PACK cm 15x14
Refrigerating brick - Briquette réfrigérante - Kühlakku - Refrigirad

Cod. 5BA16020
1 BACINELLA GN 1/6 h 20
Gastronorm basin - Bac gastronorm - Durchbrochener basis - Cubeta gastronómica

Cod. 50902613
1 GRIGLIA 1/6 PER DISTRIBUTORE
Grill for dispenser - Grille pour distributeur - Rost für Getränkedispenser - Baño maria gastronomico

LE BASI



Cod. 518A0006 - **Euro 160,00**
BASE DISTRIB. SUCCHI SALVIA h cm 24
Structure for juice dispenser sage - Structure pour distributeur à jus vert - Struktur für Saftdispenser Salvia - Estructura para dispensador de zumos verde



Cod. 518B0006 - **Euro 160,00**
BASE DISTRIB. SUCCHI BURRO h cm 24
Structure for juice dispenser cream - Structure pour distributeur à jus crème - Struktur für Saftdispenser Burro - Estructura para dispensador de zumos crema



Cod. 518C0006 - **Euro 160,00**
BASE DISTRIB. SUCCHI CAFFÈ h cm 24
Structure for juice dispenser coffee - Structure pour distributeur à jus brun - Struktur für Saftdispenser Caffè - Estructura para dispensador de zumos marron



Cod. 518D0006 - **Euro 160,00**
BASE DISTR. SUCCHI CARBONE h cm 24
Structure for juice dispenser coal - Structure pour distributeur à jus gris - Struktur für Saftdispenser Carbone - Estructura para dispensador de zumos gris



DISTRIBUTORE SUCCHI It 5

Euro 320,00

Juice and cold drink dispenser.

Fontaine à jus de fruits simple paroi.

Spender für Saft und kalte Getränke.

Surtidor de zumos y bebidas con grifo Tomlinson.



LA PARTE FUNZIONALE



Cod. F1805420 - **Euro 180,00**
DISTRIBUTORE SUCCHI It 7
Juice and cold drink dispenser - Fontaine à jus de fruits simple paroi - Spender für Saft und kalte Getränke - Surtidor de zumos y bebidas con grifo Tomlinson

COMPOSIZIONE:

Cod. 97150864
1 CONTENITORE IN VETRO
CON RUBINETTO It 7
Juice dispenser with tap - Fontaine à jus de fruits avec robinet - Saftspender mit shahn - Surtidor de zumos con grifo

Cod. 97150865
1 VASCHETTA PER DISTRIB. SUCCHI
Juices bowl distributor - Petit bac pour fontaine à jus - Schale für Saftspender - Cubeta de surtidor de zumos

Cod. 97150866
1 COPERCHIO PER VASCHETTA
DISTR. SUCCHI
Lid for juices bowl distributor - Couvercle petit bac pour fontaine à jus - Deckel für Saftspender - Tapa por cubeta de surtidor de zumos

Cod. 97150867
1 GEL PACK cm 15x14
Refrigerating brick - Briquette réfrigérante - Kühlakku - Refrigerad

Cod. 5BA16020
1 BACINELLA GN 1/6 h 20
Gastronorm basin - Bac gastronorm - Durchbrochener basis - Cubeta gastronómico

Cod. 50902613
1 GRIGLIA 1/6 PER DISTRIBUTORE
Grill for dispenser - Grille pour distributeur - Rost für Getränkedispenser - Baño maria gastronómico

LE BASI



Cod. 518A0006 - **Euro 160,00**
BASE DISTRIB. SUCCHI SALVIA h cm 24
Structure for juice dispenser sage - Structure pour distributeur à jus verte - Struktur für Saftdispenser Salvia - Estructura para dispensador de zumos verde



Cod. 518B0006 - **Euro 160,00**
BASE DISTRIB. SUCCHI BURRO h cm 24
Structure for juice dispenser cream - Structure pour distributeur à jus crème - Struktur für Saftdispenser Burro - Estructura para dispensador de zumos crema



Cod. 518C0006 - **Euro 160,00**
BASE DISTRIB. SUCCHI CAFFÈ h cm 24
Structure for juice dispenser coffee - Structure pour distributeur à jus brun - Struktur für Saftdispenser Caffè - Estructura para dispensador de zumos marron



Cod. 518D0006 - **Euro 160,00**
BASE DISTR. SUCCHI CARBONE h cm 24
Structure for juice dispenser coal - Structure pour distributeur à jus gris - Struktur für Saftdispenser Carbone - Estructura para dispensador de zumos gris



DISTRIBUTORE SUCCHI It 7

Euro 340,00

Juice and cold drink dispenser.

Fontaine à jus de fruits simple paroi.

Spender für Saft und kalte Getränke.

Surtidor de zumos y bebidas con grifo Tomlinson.



LA PARTE FUNZIONALE



Cod. F1809527 - **Euro 500,00**
 DISTRIBUTORE BEVANDE CALDE It 5
 Hot drinks dispenser provided with electric resistance - Distributeurs de boissons chaudes avec résistance électrique - Spender für warme Getränke ausgestattet mit elektrischer Heizung - Distribuidores de bebidas calientes con resistencia eléctrica

COMPOSIZIONE:

Cod. F0959524
 1 DISTRIB. BEVANDE CALDE C/MANIGLIE It 5
 Hot drink dispenser - Distributeur de boissons chaudes - Spender für warme Getränke - Rejilla para dispensador

Cod. 5BA16020
 1 BACINELLA GN 1/6 h 20
 Gastronorm basin - Bac gastronorm - Durchbrochener basis - Cubeta gastronómica

Cod. F0959516
 1 GRIGLIA 1/6 PER DISTRIBUTORE
 Grill for dispenser - Grille pour distributeur - Rost für Getränkedispenser - Baño maría gastronómico

Cod. F1803116
 1 COPERCHIO PER DISTR. BEVANDE CALDE
 Lid for dispenser - Couvercle pour distributeur - Deckel für dispenser - Tapa para dispensador

Cod. 97150221
 1 RUBINETTO SMONT. IN PPL TOMLINSON
 Tomlinson PPL faucet - Robinet démontable en PPL Tomlinson - Abnehmbarer hahn aus PPL Tomlinson - Grifo desmontable de PPL Tomlinson

Cod. 97150870
 1 RESISTENZA ELETTRICA
 C/REGOLATORE 140 W
 Electric resistance - Résistance électrique - Elektrischer Widerstand - Resistencia eléctrica

LE BASI



Cod. 518A0007 - **Euro 180,00**
 BASE DISTRIB. BEVANDE CALDE SALVIA
 Structure for hot drink dispenser sage - Struct. pour distrib. à boissons chaudes vert - Struktur für warme Getränke Dispenser Salvia - Estructura para disp. de bebidas calientes verde



Cod. 518B0007 - **Euro 180,00**
 BASE DISTRIB. BEVANDE CALDE BURRO
 Structure for hot drink dispenser cream - Struct. pour distrib. à boissons chaudes crème - Struktur für warme Getränke Dispenser Burro - Estructura para disp. de bebidas calientes crema



Cod. 518C0007 - **Euro 180,00**
 BASE DISTRIB. BEVANDE CALDE CAFFÈ
 Structure for hot drink dispenser coffee - Struct. pour distrib. à boissons chaudes brun - Struktur für warme Getränke Dispenser Caffè - Estructura para disp. de bebidas calientes marron



Cod. 518D0007 - **Euro 180,00**
 BASE DISTR. BEVANDE CALDE CARBONE
 Structure for hot drink dispenser coal - Struct. pour distrib. à boissons chaudes gris - Struktur für warme Getränke Dispenser Carbone - Estructura para disp. de bebidas calientes gris



DISTRIBUTORE BEVANDE CALDE CON RESISTENZA ELETTRICA It 5 Euro 680,00

Hot drinks dispenser provided with electric resistance.
 Distributeurs de boissons chaudes avec résistance électrique.
 Spender für warme Getränke ausgestattet mit elektrischer Heizung.
 Distribuidores de bebidas calientes con resistencia eléctrica.



COMPOSIZIONE

1 PORTA BROCCHE h cm 7,5
Jug holder
Porte-carafes
Krughalter
Porta-jarras
Cod. 518A9818 SALVIA / sage
Cod. 518B9818 BURRO / cream
Cod. 518C9818 CAFFÈ / coffee
Cod. 518D9818 CARBONE / coal
Euro 100,00

Cod. 97150305
1 VASCHETTA RACCOGLI GOCCE
Drop-saver bowl
Bac à goutess
Tropfschale
Cubeta de recoger gotas

Cod. 97150276
2 GEL PACK cm 20x9,8
Refrigerating brick
Briquette réfrigérante
Kühlakku
Refrigerad

Cod. 97150861
1 COPERCHIO INOX PER
VASCHETTA RACCOGLI GOCCE
Drop-saver lid for drop-saver bowl
Couvercle por bac à goutes
Edelstahlabdeckung für Tropfschale
Tapa de acero por cubeta de recoger gotas

Cod. 97150862
3 CARAFFA CON COPERCHIO lt 2,2
Jug with lid
Carafe avec couvercle
Karaffe mit Deckel
Jarra con tapa



Cod. 518A9818 - **Euro 350,00**
DISTRIBUTORE CEREALI / SUCCHI SALVIA
39x12,8x30 h cm
Cereal dispenser sage.
Distributeur à céréales vert.
Cerealien-Spender Salvia.
Dispensador de cereales verde.



Cod. 518B9818 - **Euro 350,00**
DISTRIBUTORE CEREALI / SUCCHI BURRO
39x12,8x30 h cm
Cereal dispenser cream.
Distributeur à céréales crème.
Cerealien-Spender Burro.
Dispensador de cereales crema.



Cod. 518C9818 - **Euro 350,00**
DISTRIBUTORE CEREALI / SUCCHI CAFFÈ
39x12,8x30 h cm
Cereal dispenser coffee.
Distributeur à céréales brun.
Cerealien-Spender Caffè.
Dispensador de cereales marron.



Cod. 518D9818 - **Euro 350,00**
DISTRIBUTORE CEREALI / SUCCHI CARBONE
39x12,8x30 h cm
Cereal dispenser coal.
Distributeur à céréales gris.
Cerealien-Spender Carbone.
Dispensador de cereales gris.



PINTI *buffet*

CALEIDO

-

Avete in mente un colore particolare?

Possiamo realizzare le basi proprio con quel colore! Per prezzi, tempistiche e ordini minimi contattateci.

Are you thinking about a particular colour?

We can make bases using it! Contact us for prices, lead time and MOQ.



RICAMBI

Spare parts

- Cod. 97150856 CUPOLA RETTANGOLARE / Rectangular dome lid **Euro 62,08**
- Cod. 97150857 PIASTRA INOX / Refrigerated stainless steel plate **Euro 52,00**
- Cod. 97150858 TAGLIERE IN POLIPROPILENE cm 54,7x34,2 / Polypropilene board cm 54,7x34,2 **Euro 80,00**
- Cod. 97150859 TAGLIERE PANE IN NOCE CANALETTO cm 27,5x34,5 / Bread board cm 27,5x34,5 **Euro 29,00**
- Cod. 97150860 CESTA PANE IN TESSUTO / Woven bread basket **Euro 20,90**
- Cod. 97150861 COPERCHIO VASCHETTA RACCOGLI GOCCE / Drop-saver lid for drop-saver bowl **Euro 13,90**
- Cod. 97150305 VASCHETTA RACCOGLI GOCCE / Drop-saver bowl **Euro 29,30**
- Cod. 97150862 CARAFFA CON COPERCHIO lt 2,2 / Jug with lid lt 2,2 **Euro 70,00**
- Cod. 97150863 CONTENITORE IN VETRO CON RUBINETTO LT 5 / Juice glass dispenser with tap lt 5 **Euro 90,00**
- Cod. 97150864 CONTENITORE IN VETRO CON RUBINETTO LT 7 / Juice glass dispenser with tap lt 7 **Euro 116,00**
- Cod. 97150865 VASCHETTA PER DISTRIBUTORE SUCCHI / Juices bowl distributor **Euro 34,00**
- Cod. 97150866 COPERCHIO PER VASCHETTA DISTRIBUTORE SUCCHI / Lid for juices bowl distributor **Euro 14,00**
- Cod. 97150867 GEL PACK cm 15x14 / Refrigerating brick cm 15x14 **Euro 2,58**
- Cod. 97150276 GEL PACK cm 20x9,8 / Refrigerating brick cm 20x9,8 **Euro 2,58**
- Cod. F0959516 DISTRIBUTORE BEVANDE CALDE C/MANIGLIE lt 5 / Hot drink dispenser lt 5 **Euro 110,00**
- Cod. F1803116 COPERCHIO PER DISTRIBUTORE BEVANDE CALDE / Lid for hot drink dispenser **Euro 33,00**
- Cod. 97150221 RUBINETTO COMPLETO TOMLINSON / Tomlinson faucet **Euro 64,68**
- Cod. 97150759 CESTA PANE RETTANGOLARE WENGE C/FORCELLA CON CUPOLA cm 52,5x32x29,5/ Wenge rectangular bread basket with hooks with cover cm 52,5x32x29,5 **Euro 104,86**
- Cod. 97150869 CESTA PANE RETTANGOLARE PAGLIA C/FORCELLA CON CUPOLA cm 52,5x32x29,5/ Paill rectangular bread basket with hooks with cover cm 52,5x32x29,5 **Euro 104,86**
- Cod. 97150870 RESISTENZA PER DISTRIBUTORE BEVANDE CALDE 140 W / Heater for hot drink dispenser 140 W **Euro 213,00**
- Cod. 97150118 RESISTENZA CON REGOLATORE PER CHAFING DISH 230 V 700 W / Heater with adjuster for chafing dish 230 V 700 W **Euro 227,12**
- Cod. 97200078 FORNELLETTO INOX / Stainless steel burner holder **Euro 9,36**
- Cod. 97150071 SUPPORTO PER FRIZIONE CHAFING DISH / Friction support for chafing dish **Euro 10,50 cad.**
- Cod. 97150023 FRIZIONE DESTRA CHAFING DISH / Friction right for chafing dish **Euro 11,76**
- Cod. 97150023 FRIZIONE SINISTRA CHAFING DISH / Friction left for chafing dish **Euro 11,76**
- Cod.90230815 TARGHETTA "LATTE - CAFFÈ" PER BROCCA Ø cm 6,5 / Plate "Milk - Coffee" for jug Ø cm 6,5 **Euro 2,74**
- Cod.90230810 TARGHETTA "LATTE - ACQUA CALDA" PER BROCCA Ø cm 6,5 / Plate "Milk - Hot Water" for jug Ø cm 6,5 **Euro 2,74**

GASTRONORM

1/1 2/3 1/2 2/4 1/3 1/4 2/8 1/6 1/9

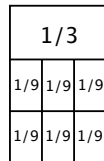
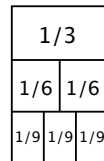
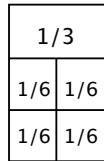
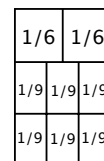
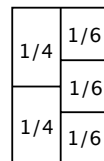
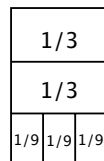
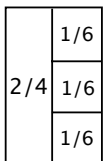
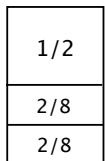
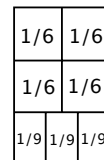
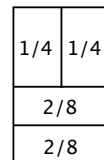
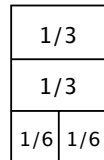
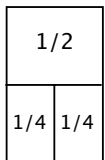
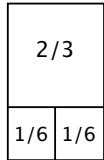

ACCIAIO E SPESSORI

La serie Gastronorm è prodotta con acciaio AISI 304, chiamato anche 18/10, negli spessori:

- 1 mm per i modelli 2/1
- 0,7 e 0,8 per le altre pezzature restanti

LUCIDATURA

Le altezze 100, 150, 200 sono sottoposte ad una operazione di normalizzazione termica e poi lucidate mediante burattatura. Oggetti di grandi dimensioni sono puliti per via elettrolitica. Le altezze 65, 40 e 20 e sottoposte a trattamento chimico che permette di ottenere una lucidatura omogenea su tutta la superficie.

CONFEZIONE

Ogni singolo pezzo è sottoposto a lavaggio speculare ad alta temperatura 90° e confezionato in polipropilene pronto per l'uso già sterilizzato.

CAPACITÀ

I raggi ridotti al min. offrono il max della capienza nel minimo ingombro.

MATERIALI

Sono tutti certificati ed idonei al contatto con gli alimenti ai sensi dell' DM. 25-1-1992 art. 4-5° comma D.L. 208 e DIR. CEE 89/109.

LAVAGGIO

Resistenti all'uso prolungato in lavastoviglie.

MISURE

In accordo con gli standard internazionali della CEE doc. CEN/TC 194 EN631-1.

THE STEEL AND THE THICKNESSES

The Gastronorm range is made of AISI 304 steel also called 18/10, in the following thicknesses:

- 1 mm for the 2/1 models
- 0,7 and 0,8 for the remaining sizes

POLISHING

Heights 100, 150 and 200 are thermally normalised and then polished by tumbling. Large items are etch cleaned. Heights 65, 40 and 20 and are subjected to a chemical treatment permitting the attainment of even polishing over the entire surface.

PACKAGING

Each individual piece is bright washed at the high temperature of 90° and packaged in polypropylene, ready for use already sterilised.

CAPACITY

The finely rounded bottom edges offer maximum capacity in the minimum space.

MATERIALS

All the materials are certified to be suitable for contact with foodstuffs according to DM. 25-1-1992 art. 4 - 5th para. D.L. 208 and EEC Directive 89/109.

WASHING

Resistant to prolonged dish-washing.

SIZES

In accordance with the international EEC standards doc. CEN/TC 194 EN631-1.

NOTE INFORMATIVE Technical information

ACCIAIO INOX 18/10

L'acciaio Inox 18/10 - Aisi 304 viene fornito esclusivamente dalle principali acciaierie europee. La sua eccezionale resistenza alla ruggine, la brillantezza e le caratteristiche igieniche soddisfano i requisiti della moderna gastronomia. Esso infatti resiste agli acidi contenuti nei prodotti alimentari, nei detersivi. L'acciaio Inox 18/10 è antiurto e particolarmente adatto al lavaggio in lavastoviglie.

POLICARBONATO (PC)

Il policarbonato è un polimero di pregio che racchiude alcune caratteristiche della plastica, dell'acciaio e del vetro. La trasparenza si avvicina al 90%. La resistenza meccanica alla deformazione ha un'elevata resistenza all'urto. L'elevata stabilità dimensionale viene garantita fino ad una temperatura di 130 gradi. In presenza di fiamma è autoestinguente.

Avvertenze. Non resiste a: soluzioni alcaline, acetone, ammoniaca, benzolo ed alcool metilico. Il materiale è sicuro dal punto di vista fisiologico e può andare a contatto con gli alimenti.

COMPONENTI IN LEGNO

Tutti i prodotti in legno sono realizzati in noce canaletto.

Avvertenze. Per mantenere a lungo la qualità del prodotto è necessario:

- Non immergere in liquidi o acqua
- Pulire con panno umido d'acqua
- Asciugare sempre con cura
- Evitare l'utilizzo di sostanze abrasive
- Tenere lontano da fiamme libere o fonti di calore
- Evitare l'esposizione prolungata al sole, per evitare variazione di colore e deformazioni.

NB. Il legno essendo un prodotto naturale può assumere tolleranze diverse a seconda della temperatura e dell'umidità presente nell'ambiente circostante. Sono possibili eventuali gradazioni di colore e venature in quanto prodotto in legno naturale.

POLIPROPILENE

Il polipropilene è ad alta resistenza e garantito per alimenti.

RESISTENZE

Sono adatte a un voltaggio di 220 Volts e dotate di spina schuko. Conformi alle leggi CEE. Per distributore bevande calde o chafing dish non utilizzare con contenitori vuoti. Per il corretto utilizzo e per la manutenzione fare comunque riferimento alle note presenti all'interno della confezione.

18/10 AISI 304 STAINLESS STEEL

18/10 AISI 304 stainless steel is supplied almost exclusively by the main European steelworks. Its exceptional rust resistance, its brilliance and hygienic qualities satisfy the requirements of modern gastronomy; in fact, it resists to the acids contained in foodstuffs, detergents and is shockproof. 18/10 steel is dishwasher safe.

POLYCARBONATE (PC)

Polycarbonate is a valuable polymer that has some characteristics from plastics, steel and glass. Its transparency is close to 90%. Its strain strength has a high impact strength. Its high dimensional stability is guaranteed up to a 130-degree temperature. In the presence of flame, it is self-extinguishing.

Warning: it does not withstand: alkaline solutions, acetone, ammonia, benzol and methyl alcohol. The material is safe from the physiological point of view and can get in touch with food.

WOOD COMPONENTS

All the wood products are made in Canaletto walnut.

Warning. To guarantee the quality of the product in the time:

- Do not plunge in liquids or in water
- Clean with a water-dampened cloth
- Dry with care
- Do not use abrasive agents or solvents
- Keep away from flames or heat sources
- Do not expose to the sun for a long-time to avoid colour changes and deformations.

N.B.Wood is a natural product and can have different tolerances according to the environment temperature and humidity.

This product made of natural wood may have different colour nuances and veins China is suitable for food usage and does not contain harmful substances or release dangerous elements.

POLYPROPYLENE

Polypropylene is highly resistant and suitable for foodstuff.

RESISTANCES

The electric resistance is suitable for 220 W voltage and are provided with schuko plug . In compliance with CEE norm. For hot drink dispenser and chafing dish. Do not use with empty drink dispenser and chafing dish. For a correct use please refer to the instructions leaflet inside the box.

PINTI *buffet*

MADE IN ITALY

CALEIDO

-

2018

PINTI INOX S.p.A.
Via Antonini, 87
25068 Sarezzo (BS) Italia
Tel. +39 030 89351
Fax +39 030 8935250
+39 030 8901163
pintinox@pinti.it
www.pinti.it

PINTI INOX GMBH DEUTSCHLAND
Römerstraße 91
73066 Uhingen
Tel +49 07161 93343-0
Fax +49 07161 352789
info@pinti.de
www.pinti.de

-

Si ringrazia il ristorante *Nineteen - 19* a Brescia per l'ospitalità nelle foto ambientate.

art director: Daniele Ardisson
product manager: Ruggero Borghetti
graphic design: Elena Maccabiani
photos: Claudio Sambinelli
cod. catalogo: 98900455