

Professional Cleaning Equipment

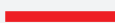

Catalogo Tecnico



Italiano



Sommario

Azienda	5	Strizzatori	165
Carrelli Strizzatori	13	Secchi e Componenti in Plastica	171
Mono	16	Contenitori in Plastica	183
Duo	25	Telai e Frange di Scopatura	189
Carrelli Portasacco	41	Telai e Frange di Lavaggio	199
Multiuso Plastica Carenati	55	Mop e Pinze	211
DMX	58	Manici e Aste Telescopiche	219
MX	76	Linea Vetri e Spingiacqua	227
Multiuso Plastica Aperti	91	Prodotti Vari Professionali	239
Ideabase	94	Linea Sanità	251
Ideabase PL	103	DMX - Pre	254
Ideaplus	106	Linea Hotel	267
Multiuso Cromati	115	Classic	270
MINIMAX	118	Innovative	280
L	120	Elba	294
HO	124		
JOKER	128		
H	134		
EF	138		
Multiuso con Protezione Rilsan	143		
EUROPE	146		
BIO - R	147		
Multiuso Acciaio Inox	153		
BIOSTEEL	156		



Sistemi di pulizia professionali

I prodotti VDM sono progettati e **realizzati basandoci sullo studio delle specifiche esigenze dei nostri clienti**.

In questo modo siamo in grado di **creare sistemi che massimizzano gli standard ed i protocolli** di pulizia, riducendo i costi operativi e soddisfacendo le richieste degli operatori più esigenti.

I nostri carrelli **sono il risultato di un'attenzione particolare al design**. L'impegno costante di VDM è finalizzato ad **offrire all'operatore** una sempre **maggiore funzionalità ed ergonomia** unite ad un'**estetica unica e distintiva**.

I nostri valori sono:

Qualità

Durata

Ergonomia

Resistenza/Robustezza

Innovazione

Cura dei particolari

Tecnologia

Design

Sostenibilità/Responsabilità ambientale



La nostra storia

Da oltre 40 anni, **studiamo e progettiamo con cura e passione attrezzature professionali per la pulizia e sistemi sempre più innovativi** per rispondere alle **esigenze di un mercato in continua evoluzione**.

Siamo presenti sul mercato nazionale ed internazionale **con distributori in oltre 64 paesi nei 5 continenti**.

VDM da sempre investe risorse ed impegno nell'individuare **soluzioni esclusive al servizio delle pulizie professionali**.

In Italia il primo brevetto nel mondo delle attrezzature professionali è stato di VDM. Tra i tanti, la **pressa Elparoll** ha rivoluzionato il settore delle pulizie professionali.





Sostenibilità/Responsabilità ambientale

Da sempre VDM opera nel rispetto dell'ambiente, perseguendo una politica di qualità e ambientale, grazie al continuo sviluppo di un sistema di gestione integrato.

In Italia VDM è stata la prima azienda di attrezzature professionali ad essere certificata:

Norma UNI EN ISO 9001

Norma UNI EN ISO 14001

Le due certificazioni impegnano l'azienda in un continuativo processo di miglioramento strutturale e organizzativo che porti ad ottenere un servizio orientato alla qualità del prodotto e alla salvaguardia dell'ambiente.

DICHIARAZIONE DI CONFORMITÀ

Tutti gli articoli di nostra produzione sono conformi alle vigenti norme in materia di sicurezza e sono coperti da polizza di Responsabilità civile prodotti.



La nostra formazione

VDM ha sviluppato negli anni una **struttura in grado di supportare il Distributore e il Cliente finale con servizi ad alto valore aggiunto**:

Assistenza

Formazione

Addestramento

Marketing

Il **rinomato Centro di Formazione VDM** è infatti in grado di **fornire al cliente un'assistenza a 360°**, a partire dagli **aspetti tecnici**, dalla formulazione di una proposta di **sistemi innovativi pensati «ad hoc»**, fino all'**avvio del cantiere e successivi controlli**.

Inoltre, agli **Operatori del settore, Capo Cantieri e Venditori** sono **riservati corsi di formazione professionale sia in aula che in cantiere**.





Carrelli Strizzatori

Mono

16

Duo

25

Carrelli Strizzatori



Modulare. Utilizzando lo strizzatore a rullo ELPAROLL (art. 3501 VDM) è possibile lavorare aggiungendo un secchio supplementare da 12 lt per trasformare un monovasca in doppia vasca separando l'acqua sporca da quella pulita.



Vani integrati nella struttura. Nel telaio del carrello monovasca è presente un vano dove è possibile riporre detersivi, un secchio da 4 lt o oggetti vari.



Accessori. Possono essere accessoriati con cassetta portaoggetti/secchio 4 lt e tasca laterale in plastica.





Dettagli unici. Il manico in plastica è stampato con tecnica "gas moulding" che lo rende leggero in quanto vuoto al suo interno. Oltre ad essere molto robusto, è provvisto di un esclusivo sistema di rotazione che permette 5 diverse posizioni.



Stabili e robusti. Il carrello è strutturato per sostenere forti pressioni durante la strizzatura (il fondo dello strizzatore poggia su una sede rinforzata su tre punti). Inoltre grazie al baricentro ruote sporgente ed al sistema brevettato di aggancio ruote saldamente ancorate al secchio è assicurata la massima stabilità.



Codice	Descrizione	Colore
--------	-------------	--------

SKY 1.15 Carrello in plastica mono 1x15 lt

SKY 1.15 S/P Carrello in plastica mono 1x15 lt senza pressa

24040SKY/STD	1 Telaio SKY singolo completo di 4 ruote Ø 80 mm (art. 1038)	
24028	1 Supporto SKY per secchio 15 lt	●
1205 R	1 Secchio 15 lt	●
24021SKY/STD	1 Portapressa SKY senza manico	
4100PA	1 Strizzatore in plastica	●





Codice	Descrizione	Colore
--------	-------------	--------

SKY 1.25 Carrello in plastica mono 1x25 lt

SKY 1.25 S/P Carrello in plastica mono 1x25 lt senza pressa

24040SKY/STD	1 Telaio SKY singolo completo di 4 ruote Ø 80 mm (art. 1038)	
1005 R	1 Secchio 25 lt	●
24021SKY/STD	1 Portapressa SKY senza manico	
4100PA	1 Strizzatore in plastica	●

 55x46x88h cm

	1 Pz/cartone	8,2 Kg	0,125 m ³
	1 Pz/cartone	6,1 Kg	0,125 m ³

 55x46x88h cm

	1 Pz/cartone	8,2 Kg	0,125 m ³
	1 Pz/cartone	6,1 Kg	0,125 m ³

Plastica



Codice	Descrizione	Colore
--------	-------------	--------

SKY 1.15 MP	Carrello mono 1x15 lt con manico in plastica	
--------------------	---	--

SKY 1.15 MPS/P	Carrello mono 1x15 lt con manico in plastica e senza pressa	
-----------------------	--	--

24040SKY/STD	1 Telaio SKY singolo completo di 4 ruote Ø 80 mm (art. 1038)	
24028	1 Supporto SKY per secchio 15 lt	●
1205 R	1 Secchio 15 lt	●
24021SKY/MP	1 Portapressa SKY con manico reversibile in plastica	
4100PA	1 Strizzatore in plastica	●

Codice	Descrizione	Colore
--------	-------------	--------

SKY 1.25 MP	Carrello mono 1x25 lt con manico in plastica	
--------------------	---	--

SKY 1.25 MP S/P	Carrello mono 1x25 lt con manico in plastica e senza pressa	
------------------------	--	--

24040SKY/STD	1 Telaio SKY singolo completo di 4 ruote Ø 80 mm (art. 1038)	
1005 R	1 Secchio 25 lt	●
24021SKY/MP	1 Portapressa SKY con manico reversibile in plastica	
4100PA	1 Strizzatore in plastica	●

55x46x88h cm	1 Pz/cartone	8,7 Kg	0,125 m ³
	1 Pz/cartone	6,6 Kg	0,125 m ³

55x46x88h cm	1 Pz/cartone	8,7 Kg	0,125 m ³
	1 Pz/cartone	6,6 Kg	0,125 m ³



Codice	Descrizione	Colore
ALEX 1A+P	Secchio carrellato in plastica mono 20 lt	●
ALEX 1G+P	Secchio carrellato in plastica mono 20 lt	●
ALEX 1R+P	Secchio carrellato in plastica mono 20 lt	●
ALEX 1V+P	Secchio carrellato in plastica mono 20 lt	●
ALEX 1A S/P	Secchio carrellato in plastica mono 20 lt senza pressa	●
ALEX 1G S/P	Secchio carrellato in plastica mono 20 lt senza pressa	●
ALEX 1R S/P	Secchio carrellato in plastica mono 20 lt senza pressa	●
ALEX 1V S/P	Secchio carrellato in plastica mono 20 lt senza pressa	●
1006/A	1 Secchio 20 lt ALEX	●
GR1009/SET	1 Set supporti ALEX completi di ruote (4 pz)	●
4100PA	1 Strizzatore in plastica	●

Codice	Descrizione	Colore
ALEX 2A+P	Secchio carrellato in plastica duo 20 lt (10+10)	●
ALEX 2G+P	Secchio carrellato in plastica duo 20 lt (10+10)	●
ALEX 2R+P	Secchio carrellato in plastica duo 20 lt (10+10)	●
ALEX 2V+P	Secchio carrellato in plastica duo 20 lt (10+10)	●
ALEX 2A S/P	Secchio carrellato in plastica duo 20 lt (10+10) senza pressa	●
ALEX 2G S/P	Secchio carrellato in plastica duo 20 lt (10+10) senza pressa	●
ALEX 2R S/P	Secchio carrellato in plastica duo 20 lt (10+10) senza pressa	●
ALEX 2V S/P	Secchio carrellato in plastica duo 20 lt (10+10) senza pressa	●
1006/A	1 Secchio 20 lt ALEX	●
2235 A	1 Secchio 12 lt	●
GR1009/SET	1 Set supporti ALEX completi di ruote (4 pz)	●
4100PA	1 Strizzatore in plastica	●

52x40x82h cm	1 Pz/cartone 7 Kg 0,100 m ³
	3 Pz/cartone 12 Kg 0,100 m ³

52x40x82h cm	1 Pz/cartone 7,3 Kg 0,100 m ³
	2 Pz/cartone 9 Kg 0,100 m ³

Plastica



Codice	Descrizione	Colore
--------	-------------	--------

ALEX COMBI	Secchio carrellato in plastica a rulli 20 lt (10+10) Secchio carrellato ergonomico in plastica da 20 lt (10+10) completo di 1 secchio da 12 lt, 2 rulli elastici con movimento a pedale, leveraggi in acciaio inox (AISI 304), griglietta di separazione dello sporco, 4 ruote Ø 80 mm con parafile e supporti di sostegno	●
-------------------	--	---

Codice	Descrizione	Colore
--------	-------------	--------

MAC 50A+P	Secchio carrellato in plastica mono 20 lt	●
MAC 50G+P	Secchio carrellato in plastica mono 20 lt	●
MAC 50R+P	Secchio carrellato in plastica mono 20 lt	●
MAC 50V+P	Secchio carrellato in plastica mono 20 lt	●
MAC 50A S/P	Secchio carrellato in plastica mono 20 lt senza pressa	●
MAC 50G S/P	Secchio carrellato in plastica mono 20 lt senza pressa	●
MAC 50R S/P	Secchio carrellato in plastica mono 20 lt senza pressa	●
MAC 50V S/P	Secchio carrellato in plastica mono 20 lt senza pressa	●
1070 A	1 Secchio 20 lt MAC	●
1075	4 Supporti con ruota Ø 50 mm per MAC	●
4100PA	1 Strizzatore in plastica	●

 52x40x55h cm |  1 Pz/cartone 7,7 Kg 0,125 m³



 40x35x75h cm |  1 Pz/cartone 5 Kg 0,065 m³
 3 Pz/cartone 7,7 Kg 0,100 m³





Codice	Descrizione	Colore
MAC 80A+P	Secchio carrellato in plastica mono 20 lt	●
MAC 80G+P	Secchio carrellato in plastica mono 20 lt	●
MAC 80R+P	Secchio carrellato in plastica mono 20 lt	●
MAC 80V+P	Secchio carrellato in plastica mono 20 lt	●
MAC 80A S/P	Secchio carrellato in plastica mono 20 lt senza pressa	●
MAC 80G S/P	Secchio carrellato in plastica mono 20 lt senza pressa	●
MAC 80R S/P	Secchio carrellato in plastica mono 20 lt senza pressa	●
MAC 80V S/P	Secchio carrellato in plastica mono 20 lt senza pressa	●
1070 A	1 Secchio 20 lt MAC	●
1076	4 Supporti con ruota Ø 80 mm per MAC	●
4100PA	1 Strizzatore in plastica	●

Codice	Descrizione	Colore
4600	Secchio carrellato in plastica 20 lt MAC ROLL	●
4600 S/P	Secchio carrellato in plastica 20 lt MAC ROLL senza pressa	●
1070 A	1 Secchio 20 lt MAC	●
1075	4 Supporti con ruota Ø 50 mm per MAC	●
4601	1 Strizzatore a rullo in plastica - semi professionale	●

Semi professionale

 40x35x80h cm	 1 Pz/cartone 5,3 Kg 0,065 m ³	 3 Pz/cartone 8,8 Kg 0,100 m ³
--	--	--

 45x32x60h cm	 1 Pz/cartone 4,8 Kg 0,065 m ³	 3 Pz/cartone 2,8 Kg 0,065 m ³
--	--	--

Plastica



Codice	Descrizione	Colore
4630	Secchio carrellato in plastica 20 Lt MAC ROLL DUO	●
4630 S/P	Secchio carrellato in plastica 20 Lt MAC ROLL DUO senza pressa	●
1070 A	1 Secchio 20 Lt MAC	●
4635	1 Secchio 8 Lt	●
1075	4 Supporti con ruota Ø 50 mm per MAC	
4601	1 Strizzatore a rullo in plastica - semi professionale	

Acciaio cromato



Codice	Descrizione	Colore
CP 2600	Carrellino cromato 12 Lt a 2 rulli con movimento a pedale	
GRCP2600	1 Telaio CP completo di rulli elastici con movimento a pedale	
2235 R	1 Secchio 12 Lt	●

Semi professionale

 45x32x60h cm |  1 Pz/cartone 5,4 Kg 0,070 m³
2 Pz/cartone 3,4 Kg 0,030 m³

 40x39x40h cm |  2 Pz/cartone 11 Kg 0,125 m³

Acciaio cromato



Codice	Descrizione	Colore
SA 1.15.80+P	Carrello cromato mono 1x15 lt	
SA 1.15.80 S/P	Carrello cromato mono 1x15 lt senza pressa	
GR1390	1 Telaio SA 1x15/25 con montante saldato completo di 4 ruote Ø 80 mm (art. 1431) e paracolpi	●
1205 R	1 Secchio 15 lt	●
4100PR	1 Strizzatore in plastica	



Codice	Descrizione	Colore
SA 1.25.80+P	Carrello cromato mono 1x25 lt	
SA 1.25.80 S/P	Carrello cromato mono 1x25 lt senza pressa	
GR1390	1 Telaio SA 1x15/25 con montante saldato completo di 4 ruote Ø 80 mm (art. 1431) e paracolpi	●
1005 R	1 Secchio 25 lt	●
4100PR	1 Strizzatore in plastica	

 48x38x90h cm



2 Pz/cartone
2 Pz/cartone

12,8 Kg
10,5 Kg

0,225 m³
0,225 m³

 48x38x90h cm



2 Pz/cartone
2 Pz/cartone

13 Kg
10,5 Kg

0,225 m³
0,225 m³

Acciaio cromato



Codice	Descrizione	Colore
SE 1.25.80+P	Carrello cromato mono 1x25 lt	
SE 1.25.80 S/P	Carrello cromato mono 1x25 lt senza pressa	
GR1905	1 Base SE 1x25 con 4 ruote Ø 80 mm (art. 1030) e paracolpi	
1005 R	1 Secchio 25 lt	●
1981	1 Verticale portapressa con antirovesciamento 1x25 lt	●
4100PR	1 Strizzatore in plastica	●
KITSE	1 Kit montaggio con piastre di fissaggio	

Codice	Descrizione	Colore
SJ 1.15.80+P	Carrello cromato mono 1x15 lt	
SJ 1.15.80 S/P	Carrello cromato mono 1x15 lt senza pressa	
GR1201	1 Telaio SJ 15/25 con montante saldato con rinforzi, portapressa con antirovesciamento e completo di 4 ruote Ø 80 mm (art. 1030) e paracolpi	
1205 R	1 Secchio 15 lt	●
4100PR	1 Strizzatore in plastica	●

 48x38x90h cm |  3 Pz/cartone 26 Kg 0,185 m³
5 Pz/cartone 29 Kg 0,185 m³

 48x38x96h cm |  2 Pz/cartone 16,5 Kg 0,225 m³
2 Pz/cartone 12 Kg 0,225 m³

Optional (raffigurati in foto)

1510 Cestello portaoggetti SE/SJ
GR1203 Manico fisso EC/SJ/LZ con viti

Acciaio cromato





Codice	Descrizione	Colore
SJ 1.25.80+P	Carrello cromato mono 1x25 lt	
SJ 1.25.80 S/P	Carrello cromato mono 1x25 lt senza pressa	
GR1201	1 Telaio SJ 15/25 con montante saldato con rinforzi, portapressa con antirovesciamento e completo di 4 ruote Ø 80 mm (art. 1030) e paracolpi	●
1005 R	1 Secchio 25 lt	●
4100PR	1 Strizzatore in plastica	





Codice	Descrizione	Colore
MINIMAX 1	Carrello cromato pieghevole mono 1x25 lt	
MINIMAX 1 S/P	Carrello cromato pieghevole mono 1x25 lt senza pressa	
GRMINIMAX1	1 Telaio pieghevole MINIMAX 1 con 4 ruote Ø 80 mm (art. 1430) e paracolpi	●
1005 R	1 Secchio 25 lt	●
2023 A	1 Vassoio MINIMAX	●
4100PR	1 Strizzatore in plastica	●

 48x38x96h cm

 2 Pz/cartone 17 Kg 0,225 m³
 2 Pz/cartone 12 Kg 0,225 m³

 55x45x97h cm

 2 Pz/cartone 22,3 Kg 0,290 m³
 2 Pz/cartone 17,8 Kg 0,290 m³

Optional (raffigurati in foto)

1510 Cestello portaoggetti SE/SJ
 GR1203 Manico fisso EC/SJ/LZ con viti

Plastica



Codice	Descrizione	Colore
SKY COMPACT	Carrello in plastica duo (1x25 lt + 1x12 lt)	
SKY COMPACT S/P	Carrello in plastica duo (1x25 lt + 1x12 lt) senza pressa	
24040SKY/STD	1 Telaio SKY singolo completo di 4 ruote Ø 80 mm (art. 1038)	
2235 A	1 Secchio 12 lt	●
1005 R	1 Secchio 25 lt	●
24021SKY/STD	1 Portapressa SKY senza manico	
4100PA	1 Strizzatore in plastica	●

Codice	Descrizione	Colore
SKY COMPACT MP	Carrello duo (1x25 lt + 1x12 lt) con manico in plastica	
SKY COMPACT MP S/P	Carrello duo (1x25 lt + 1x12 lt) con manico in plastica senza pressa	
24040SKY/STD	1 Telaio SKY singolo completo di 4 ruote Ø 80 mm (art. 1038)	
2235 A	1 Secchio 12 lt	●
1005 R	1 Secchio 25 lt	●
24021SKY/MP	1 Portapressa SKY con manico reversibile in plastica	
4100PA	1 Strizzatore in plastica	●

 61x46x88h cm
1 Pz/cartone
1 Pz/cartone9 Kg
6,9 Kg0,125 m³
0,125 m³
 61x46x88h cm
1 Pz/cartone
1 Pz/cartone9,7 Kg
7,6 Kg0,125 m³
0,125 m³



Codice	Descrizione	Colore
SKY 2.15	Carrello duo 2x15 lt con manico reversibile in rilsan	
SKY 2.15 S/P	Carrello duo 2x15 lt con manico reversibile in rilsan e senza pressa	
24020SKY/STD	1 Telaio SKY doppio completo di 4 ruote Ø 80 mm (art. 1038)	
24028	2 Supporti SKY per secchio 15 lt	●
20051	1 Manico reversibile SKY	●
1205 A	1 Secchio 15 lt	●
1205 R	1 Secchio 15 lt	●
24021SKY/STD	1 Portapressa SKY senza manico	●
4100PA	1 Strizzatore in plastica	●

Codice	Descrizione	Colore
SKY 2.25	Carrello duo 2x25 lt con manico reversibile in rilsan	
SKY 2.25 S/P	Carrello duo 2x25 lt con manico reversibile in rilsan e senza pressa	
24020SKY/STD	1 Telaio SKY doppio completo di 4 ruote Ø 80 mm (art. 1038)	
20051	1 Manico reversibile SKY	●
1005 A	1 Secchio 25 lt	●
1005 R	1 Secchio 25 lt	●
24021SKY/STD	1 Portapressa SKY senza manico	●
4100PA	1 Strizzatore in plastica	●

70x46x88h cm	1 Pz/cartone	10,5 Kg	0,185 m ³
	1 Pz/cartone	8,4 Kg	0,185 m ³

70x46x88h cm	1 Pz/cartone	10,5 Kg	0,185 m ³
	1 Pz/cartone	8,4 Kg	0,185 m ³

Plastica



Codice	Descrizione	Colore
--------	-------------	--------

SKY 2.15 MP Carrello duo 2x15 lt con manico in plastica

SKY 2.15 MPS/P Carrello duo 2x15 lt con manico in plastica e senza pressa

24020SKY/STD	1 Telaio SKY doppio completo di 4 ruote Ø 80 mm (art. 1038)	●
24028	2 Supporti SKY per secchio 15 lt	●
1205 A	1 Secchio 15 lt	●
1205 R	1 Secchio 15 lt	●
24021SKY/MP	1 Portapressa SKY con manico reversibile in plastica	●
4100PA	1 Strizzatore in plastica	●

Codice	Descrizione	Colore
--------	-------------	--------

SKY 2.25 MP Carrello duo 2x25 lt con manico in plastica

SKY 2.25 MPS/P Carrello duo 2x25 lt con manico in plastica e senza pressa

24020SKY/STD	1 Telaio SKY doppio completo di 4 ruote Ø 80 mm (art. 1038)	●
1005 A	1 Secchio 25 lt	●
1005 R	1 Secchio 25 lt	●
24021SKY/MP	1 Portapressa SKY con manico reversibile in plastica	●
4100PA	1 Strizzatore in plastica	●

1 Pz/cartone	10 Kg	0,185 m ³
1 Pz/cartone	8 Kg	0,185 m ³

1 Pz/cartone	10 Kg	0,185 m ³
1 Pz/cartone	8 Kg	0,185 m ³



Codice	Descrizione	Colore
SA 2.15.80+P	Carrello cromato duo 2x15 lt con manico reversibile	
SA 2.15.80 S/P	Carrello cromato duo 2x15 lt con manico reversibile e senza pressa	
GR1393	1 Telaio SA 2x15 completo di 4 ruote Ø 80 mm (art. 1431) e paracolpi	
1392	1 Manico reversibile SA	●
1205 A	1 Secchio 15 lt	●
1205 R	1 Secchio 15 lt	●
4100PR	1 Strizzatore in plastica	●



Codice	Descrizione	Colore
SA 2.25.80+P	Carrello cromato duo 2x25 lt con manico reversibile	
SA 2.25.80 S/P	Carrello cromato duo 2x25 lt con manico reversibile e senza pressa	
GR1391	1 Telaio SA 2x25 completo di 4 ruote Ø 80 mm (art. 1431) e paracolpi	
1392	1 Manico reversibile SA	●
1005 A	1 Secchio 25 lt	●
1005 R	1 Secchio 25 lt	●
4100PR	1 Strizzatore in plastica	●

62x45x80h cm	2 Pz/cartone	20,4 Kg	0,290 m ³
	2 Pz/cartone	16 Kg	0,290 m ³

62x45x80h cm	2 Pz/cartone	20,8 Kg	0,290 m ³
	2 Pz/cartone	16 Kg	0,290 m ³

Acciaio cromato



Codice	Descrizione	Colore
EC 2.25.80+P	Carrello cromato duo 2x25 lt con manico fisso	
EC 2.25.80 S/P	Carrello cromato duo 2x25 lt con manico fisso senza pressa	
GR1210	1 Telaio EC 2x25 completo di 4 ruote Ø 80 mm (art. 1030/ZE) e paracolpi	
GR1203	1 Manico fisso EC/SJ/LZ con viti	
1005 A	1 Secchio 25 lt	●
1005 R	1 Secchio 25 lt	●
4100PR	1 Strizzatore in plastica	●

Codice	Descrizione	Colore
E 2.15.80+P	Carrello cromato duo 2x15 lt con manico reversibile	
E 2.15.80 S/P	Carrello cromato duo 2x15 lt con manico reversibile e senza pressa	
GR1220	1 Telaio E/EMF 2x15 completo di 4 ruote Ø 80 mm (art. 1030) e paracolpi	
1025	1 Manico reversibile E	
1205 A	1 Secchio 15 lt	●
1205 R	1 Secchio 15 lt	●
4100PR	1 Strizzatore in plastica	●

Fino ad esaurimento scorte

65x42x81h cm

2 Pz/cartone
2 Pz/cartone20,4 Kg
16 Kg0,290 m³
0,290 m³

65x42x88h cm

2 Pz/cartone
2 Pz/cartone23,7 Kg
19 Kg0,290 m³
0,290 m³

Acciaio cromato



Codice	Descrizione	Colore
E 2.25.80+P	Carrello cromato duo 2x25 lt con manico reversibile	
E 2.25.80 S/P	Carrello cromato duo 2x25 lt con manico reversibile e senza pressa	
GR1015	1 Telaio E/EMF 2x25 completo di 4 ruote Ø 80 mm (art. 1030) e paracolpi	
1025	1 Manico reversibile E	●
1005 A	1 Secchio 25 lt	●
1005 R	1 Secchio 25 lt	●
4100PR	1 Strizzatore in plastica	●

Fino ad esaurimento scorte



Codice	Descrizione	Colore
EMF 2.25.80+P	Carrello cromato duo 2x25 lt con manico fisso	
EMF 2.25.80 S/P	Carrello cromato duo 2x25 lt con manico fisso e senza pressa	
GR1015	1 Telaio E/EMF 2x25 completo di 4 ruote Ø 80 mm (art. 1030) e paracolpi	
GR1090	1 Manico fisso EMF	
1095	1 Cestello portaoggetti EMF	
1005 A	1 Secchio 25 lt	●
1005 R	1 Secchio 25 lt	●
4100PR	1 Strizzatore in plastica	●
KITEMF	1 Kit montaggio EMF	

Fino ad esaurimento scorte

65x42x88h cm	2 Pz/cartone	24 Kg	0,290 m ³
	2 Pz/cartone	19 Kg	0,290 m ³

65x42x90h cm	2 Pz/cartone	24,4 Kg	0,290 m ³
	2 Pz/cartone	19 Kg	0,290 m ³

Acciaio cromato



Codice	Descrizione	Colore
P 2.15.80+P	Carrello cromato pieghevole duo 2x15 lt	
P 2.15.80 S/P	Carrello cromato pieghevole duo 2x15 lt senza pressa	
GRP15	1 Telaio pieghevole P 15 con manico fisso integrato completo di 4 ruote Ø 80 mm (art. 1430) e paracolpi	
1205 A	1 Secchio 15 lt	●
1205 R	1 Secchio 15 lt	●
4100PR	1 Strizzatore in plastica	●

Pieghevole



Codice	Descrizione	Colore
P 2.25.80+P	Carrello cromato pieghevole duo 2x25 lt	
P 2.25.80 S/P	Carrello cromato pieghevole duo 2x25 lt senza pressa	
GRP25	1 Telaio pieghevole P 25 con manico fisso integrato completo di 4 ruote Ø 80 mm (art. 1430) e paracolpi	
1005 A	1 Secchio 25 lt	●
1005 R	1 Secchio 25 lt	●
4100PR	1 Strizzatore in plastica	●

Pieghevole

 84x51x82h cm |  2 Pz/cartone 21 Kg 0,290 m³
 2 Pz/cartone 19 Kg 0,290 m³

Optional (raffigurati in foto)

1350 Cestello portaoggetti P

 84x51x82h cm |  2 Pz/cartone 24 Kg 0,290 m³
 2 Pz/cartone 19 Kg 0,290 m³

Optional (raffigurati in foto)

1350 Cestello portaoggetti P



Codice	Descrizione	Colore
BIOSTEEL P 15+P	Carrello in acciaio inox pieghevole duo 2x15 lt	
BIOSTEEL P 15S/P	Carrello in acciaio inox pieghevole duo 2x15 lt senza pressa	
GRBIOSTEELP15	1 Telaio pieghevole in acciaio inossidabile BIOSTEEL P 15 con manico fisso integrato completo di 4 ruote Ø 80 mm (art. 1430) e paracolpi	
1205 A	1 Secchio 15 lt	●
1205 R	1 Secchio 15 lt	●
4100PR	1 Strizzatore in plastica	●

Codice	Descrizione	Colore
BIOSTEEL P 25+P	Carrello in acciaio inox pieghevole duo 2x25 lt	
BIOSTEEL P 25S/P	Carrello in acciaio inox pieghevole duo 2x25 lt senza pressa	
GRBIOSTEELP25	1 Telaio pieghevole in acciaio inossidabile BIOSTEEL P 25 con manico fisso integrato completo di 4 ruote Ø 80 mm (art. 1430) e paracolpi	
1005 A	1 Secchio 25 lt	●
1005 R	1 Secchio 25 lt	●
4100PR	1 Strizzatore in plastica	●

Pieghevole

Pieghevole

 84x51x82h cm

 2 Pz/cartone
2 Pz/cartone

22,5 Kg 0,290 m³
17,7 Kg 0,290 m³

 84x51x82h cm

 2 Pz/cartone
2 Pz/cartone

22,5 Kg 0,290 m³
17,7 Kg 0,290 m³

Acciaio cromato



Codice	Descrizione	Colore
--------	-------------	--------

L 2.15.80+P	Carrello cromato duo 2x15 lt	
-------------	------------------------------	--

L 2.15.80 S/P	Carrello cromato duo 2x15 lt senza pressa	
---------------	--	--

GR1412	1 Telaio LUSO 2x15 con portapressa girevole completo di 4 ruote Ø 80 mm (art. 1430) e paracolpi	
GR1425	1 Manico reversibile LUSO	
1205 A	1 Secchio 15 lt	●
1205 R	1 Secchio 15 lt	●
4100PR	1 Strizzatore in plastica	●

Fino ad esaurimento scorte

Pressa girevole



Codice	Descrizione	Colore
--------	-------------	--------

L 2.25.80+P	Carrello cromato duo 2x25 lt	
-------------	------------------------------	--

L 2.25.80 S/P	Carrello cromato duo 2x25 lt senza pressa	
---------------	--	--

GR1415	1 Telaio LUSO 2x25 con portapressa girevole completo di 4 ruote Ø 80 mm (art. 1430) e paracolpi	
GR1425	1 Manico reversibile LUSO	
1005 A	1 Secchio 25 lt	●
1005 R	1 Secchio 25 lt	●
4100PR	1 Strizzatore in plastica	●

Fino ad esaurimento scorte

Pressa girevole

66x43x88h cm	1 Pz/cartone	13,5 Kg	0,185 m ³
	1 Pz/cartone	11 Kg	0,185 m ³



1 Pz/cartone	13,5 Kg	0,185 m ³
1 Pz/cartone	11 Kg	0,185 m ³

66x43x88h cm	1 Pz/cartone	13,5 Kg	0,185 m ³
	1 Pz/cartone	11 Kg	0,185 m ³



1 Pz/cartone	13,5 Kg	0,185 m ³
1 Pz/cartone	11 Kg	0,185 m ³



Codice	Descrizione	Colore
IDEA 15	Carrello in plastica 2x15 lt	
IDEA 15 S/P	Carrello in plastica 2x15 lt senza pressa	
20015IDEA/STD	1 Telaio duomop IDEA completo di 4 ruote Ø 80 mm (art. 1038)	
20051	1 Manico reversibile SKY	
20055	4 Supporti IDEA per secchi 15 lt	●
1205 B	1 Secchio 15 lt	●
1205 R	1 Secchio 15 lt	●
4100PR	1 Strizzatore in plastica	●

Codice	Descrizione	Colore
IDEA 25	Carrello in plastica 2x25 lt	
IDEA 25 S/P	Carrello in plastica 2x25 lt senza pressa	
20015IDEA/STD	1 Telaio duomop IDEA completo di 4 ruote Ø 80 mm (art. 1038)	
20051	1 Manico reversibile SKY	
1005 B	1 Secchio 25 lt	●
1005 R	1 Secchio 25 lt	●
4100PR	1 Strizzatore in plastica	●

70x45x88h cm	1 Pz/cartone	11,4 Kg	0,185 m ³
	1 Pz/cartone	9,1 Kg	0,185 m ³

Optional (raffigurati in foto)

20060 Vaschetta portaoggetti laterale SKY

70x45x88h cm	1 Pz/cartone	11,4 Kg	0,185 m ³
	1 Pz/cartone	9,1 Kg	0,185 m ³

Optional (raffigurati in foto)

20060 Vaschetta portaoggetti laterale SKY

Plastica/Rilsan



Codice	Descrizione	Colore
--------	-------------	--------

TROLO400SP Carrello multiuso in plastica/rilsan con struttura in piatto

20078	1 Struttura TROLO	●
20015IDEA/TROLO	1 Telaio IDEA con 4 ruote Ø 125 mm (art. 21012)	●
20051	1 Manico reversibile SKY	●
20060	2 Vaschette portaoggetti laterali SKY	●
8311/R	2 Portamanico piccolo	●
7030 B	1 Secchio rett. 22 lt	●
1005 B	1 Secchio 25 lt	●
1005 R	1 Secchio 25 lt	●
7032	1 Griglia inox pieghevole (per secchio rett. 22 lt)	●



Acciaio cromato











Codice	Descrizione	Colore
--------	-------------	--------

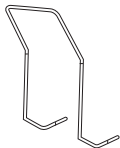
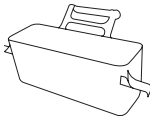
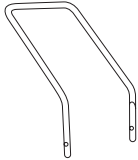



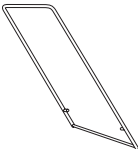
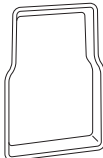
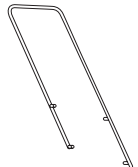
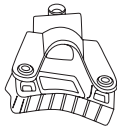
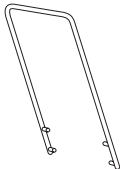
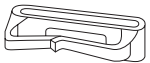
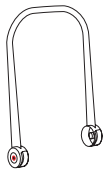

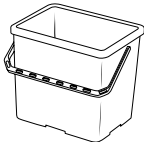



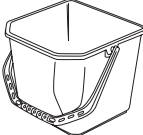

MINITROL 15 Carrello multiuso pieghevole cromato
MINITROL 15S/P Carrello multiuso pieghevole cromato senza pressa

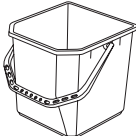
GRMINITROL	1 Telaio pieghevole MINITROL con 2 ruote Ø 80 mm (art. 1430) e 2 ruote c/freno Ø 80 mm (art. 1430/FR) e paracolpi	●
1452	1 Portasecchio MINITROL	●
2250 A	1 Secchio 6 lt	●
2250 GR	1 Secchio 6 lt	●
COMFORT A S/S	1 Secchio 15 lt COMFORT senza strizzino	●
MICRO4550	1 Strizzatore MICROROLL 4550	●
2022 A	1 Vassoio stretto	●
2255	1 Portamanico in gomma con aggancio Ø 22 mm	●

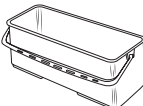
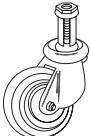
 70x54x103h cm |  1 Pz/cartone 15,40 Kg 0,33 m³

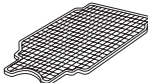
 42x36x105h cm |  1 Pz/cartone 9 Kg 0,150 m³
 1 Pz/cartone 7,5 Kg 0,150 m³

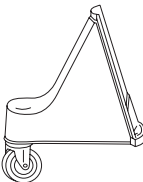
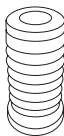
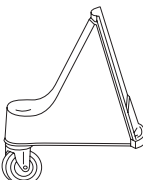
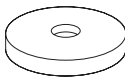
	Codice	Descrizione	Colore		Codice	Descrizione	Colore
	GR1090	Manico fisso EMF			24038	Cestello portaoggetti in plastica SKY	●
	GR1203	Manico fisso EC/SJ/LZ con viti			1510	Cestello portaoggetti SE/SJ	
	GR1425	Manico reversibile LUSSO			20060	Vaschetta portaoggetti laterale SKY	●
	1025	Manico reversibile E			2023 A	Vassoio MINIMAX	●
	1392	Manico reversibile SA			2255	Portamanico in gomma con aggancio Ø 22 mm	
	20051	Manico reversibile SKY			8311/R	Portamanico piccolo	●
	GR24030	Manico plastica SKY			24028	Supporto SKY per secchio 15 lt	●
	1095	Cestello portaoggetti EMF			2250 A 2250 GR	Secchio 6 lt	● ●
	1350	Cestello portaoggetti P			4635	Secchio 8 lt	●

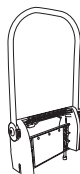
Codice	Descrizione	Colore	Codice	Descrizione	Colore
 2235 A 2235 GR 2235 R	Secchio 12 lt	● ● ●	 1076	Supporto con ruota Ø 80 mm per MAC	
 1205 A 1205 B 1205 R	Secchio 15 lt	● ● ●	 1030	Ruota Ø 80 mm con filetto 8x28 e parafilo	
 1005 A 1005 B 1005 R	Secchio 25 lt	● ● ●	 1038	Ruota Ø 80 mm con filetto 10x15	
 7030 B	Secchio rett. 22 lt	●	 1430	Ruota Ø 80 mm con espansore e parafilo	
 7038	Coperchio per secchio rett. 22 lt	●	 1431	Ruota Ø 80 mm att. codulo e parafilo	
 1008	Griglietta separazione sporco ALEX/ALEX COMBI		 21012	Ruota Ø 125 mm s/freno con filetto 10x15	
 1009/1 1009/2	Supporto n° 1 ALEX con ruota Ø 80 mm Supporto n° 2 ALEX con ruota Ø 80 mm		 1432	Bussola per ruota con att. codulo (art. 1431)	
 1009/c-1 1009/c-2	Supporto n° 1 ALEX COMBI con ruota Ø 80 mm Supporto n° 2 ALEX COMBI con ruota Ø 80 mm		 1031 1032	Paracolpi piccolo	● ●
 1075	Supporto con ruota Ø 50 mm per MAC		 24021 SKY/MP	Portapressa SKY con manico reversibile in plastica	

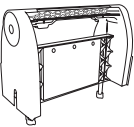
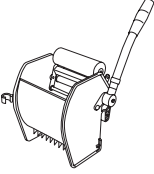
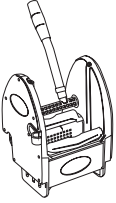
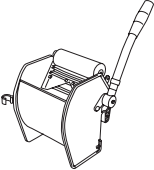
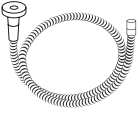
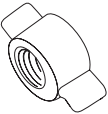
Codice	Descrizione	Colore
 24021 SKY/STD	Portapressa SKY senza manico	
 3501 VDM	Strizzatore a rullo ELPAROLL	
 4100PA 4100PG 4100PR 4100PVS	Strizzatore in plastica	● ● ● ●
 4601	Strizzatore a rullo in plastica semi professionale	
 1071	Convogliatore acqua FAST	
 21037	Ghiera filettata con alette per SKY ●	



Carrelli Portasacco

Carrelli Portasacco



Coperchi. Possono essere accessoriati con coperchi in plastica.



Praticità. Dotati di dispositivo di apertura del coperchio a pedale per una maggiore praticità e funzionalità.



Materiale dei sacchi. Possono essere personalizzati con sacchi da 120 lt o 230 lt, con sacchi in PVC o con sacchi in cotone sanforizzato.





Acciaio cromato



Codice	Descrizione	Colore
SA/X	Carrello portasacco pieghevole cromato con clip	
GRSA/X	1 Struttura carrello SA/X con 4 ruote Ø 80 mm (art. 1431)	



Codice	Descrizione	Colore
SA/XT	Carrello portasacco pieghevole cromato con elastico	
GRSA/XT	1 Struttura carrello SA/XT con 4 ruote Ø 80 mm (art. 1431)	

 53x50x104h cm |  3 Pz/cartone 20,7 Kg 0,175 m³

 53x50x104h cm |  3 Pz/cartone 20,5 Kg 0,175 m³

Optional (raffigurati in foto)

1610 Coperchio quadrato 



Codice	Descrizione	Colore
--------	-------------	--------

X 2.50.80 Carrello portasacco pieghevole cromato con anello in gomma

GRX 1 Struttura carrello X con 4 ruote Ø 80 mm (art. 1430)
1610 1 Coperchio quadrato



Codice	Descrizione	Colore
--------	-------------	--------

XE 2.50.80 Carrello portasacco pieghevole cromato con anello in gomma

GRXE 1 Struttura carrello XE con 4 ruote Ø 80 mm (art. 1430)
GR1725XE 1 Reggisacco estraibile XE con anello in gomma

53x50x104h cm | 3 Pz/cartone 26,4 Kg 0,175 m³

53x50x104h cm | 3 Pz/cartone 25,2 Kg 0,175 m³

Optional (raffigurati in foto)

1667 Cestello portaoggetti X/XE
1730 Cassetina metallo X/XE



**Acciaio Inox
(AISI 304)**



Codice	Descrizione	Colore
--------	-------------	--------

BIOSTEEL X	Carrello in acciaio inox BIOSTEEL X	
GRBIOSTEELX	1 Struttura inox carrello BIOSTEEL X con 4 ruote Ø 80 mm (art. 1430) e paracolpi	
1680/G	1 Sacco in cotone sanforizzato 230 lt	

Acciaio cromato



Codice	Descrizione	Colore
--------	-------------	--------

L 1.50.80	Carrello portasacco cromato	
GR1815	1 Base cromata 50x44 cm con 4 ruote Ø 80 mm (art. 1030) e paracolpi	
GR1625	1 Spalla multiuso con reggisacco e anello in gomma	
1610	1 Coperchio quadrato	
KITMULTIUSO/A	1 Kit montaggio L 1.50.80 - L 1.75.80	

 **53x50x104h cm** |  **2 Pz/cartone** **15 Kg** **0,175 m³**

 **50x44x102h cm** |  **2 Pz/cartone** **16,5 Kg** **0,150 m³**



Codice	Descrizione	Colore
--------	-------------	--------

L 1.50.80-PED Carrello portasacco con apertura coperchio a pedale

- GR1815/PED 1 Base cromata 50x44 cm a pedale con 4 ruote Ø 80 mm (art. 1030) e paracolpi
- GR1625 1 Spalla multiuso con reggisacco e anello in gomma
- GR1610/PED 1 Coperchio multiuso per carrello a pedale
- KITMULTIUSO/C 1 Kit montaggio L 1.50.80-PED
- KITPED 1 Kit montaggio L 1.50.80-PED

Codice	Descrizione	Colore
--------	-------------	--------

HE Carrello portasacco cromato

- GR1690 1 Portasacco HE
- 1694 1 Alberino HE per ruota fissa Ø 200 mm
- 1696 2 Ruote fisse Ø 200 mm

 50x44x102h cm |  2 Pz/cartone 16,7 Kg 0,150 m³

 55x52x93h cm |  5 Pz/cartone 30 Kg 0,150 m³



Codice	Descrizione	Colore
--------	-------------	--------

L 1.75.80-2S Carrello cromato a due sacchi 120 lt

- GR1615 1 Base cromata 75x44 cm con 4 ruote Ø 80 mm (art. 1030) e paracolpi
- GR16252S 1 Spalla multiuso 2 sacchi
- KITMULTIUSO/B 1 Kit montaggio L 1.75.80-2S



Codice	Descrizione	Colore
--------	-------------	--------

JOKER TRIO Carrello TRIO (3x120 lt) cromato

- GR8201/T 1 Base JOKER TRIO completa di 4 ruote Ø 100 mm (art. 2034) con espansore e paracolpi
- GR8202 2 Spalle JOKER
- GR8204 1 Reggisacco 70 lt JOKER con clip fermasacco
- GR8204/T 1 Reggisacco doppio JOKER TRIO con clip fermasacco
- GR8206 1 Portasacco 70 lt JOKER
- KITJOKER/D 1 Kit montaggio JOKER TRIO

 75x44x103h cm |  1 Pz/cartone 11 Kg 0,150 m³

 115x50x106h cm |  1 Pz/cartone 15,2 Kg 0,150 m³

Optional

- 1610 Coperchio quadrato
- 2101 KIT PED





Codice	Descrizione	Colore
--------	-------------	--------

IDEABASE 2 Carrello IDEABASE a 2 sacchi

- 21001IDEA/BASE 1 Base IDEA completa di 4 ruote in gomma naturale Ø 100 mm s/freno (art. 21008) ●
- 21003 B 1 Finalino per base ●
- GR21016 1 Spalla diritta in rilsan IDEABASE con reggisacco e anello in gomma
- GR5013/R 1 Reggisacco 120 lt BIO-R in rilsan con clip fermasacco e attacco coperchio (art. 7031)
- KITIDEABASE/A 1 Kit montaggio con 1 portamanico in gomma (art. 2255)

Codice	Descrizione	Colore
--------	-------------	--------

IDEABASE 3 Carrello IDEABASE a 3 sacchi

- 21001IDEA/BASE 1 Base IDEA completa di 4 ruote in gomma naturale Ø 100 mm s/freno (art. 21008) ●
- 21003 B 1 Finalino per base ●
- GR21015 1 Spalla diritta in rilsan IDEABASE
- GR5013/R 1 Reggisacco 120 lt BIO-R in rilsan con clip fermasacco e attacco coperchio (art. 7031)
- GR5027/R 1 Reggisacco DUOx70 lt BIO-R rilsan con clip fermasacco
- KITIDEABASE/A 1 Kit montaggio con 1 portamanico in gomma (art. 2255)

 83x52x105h cm |  1 Pz/cartone 12,7 Kg 0,225 m³









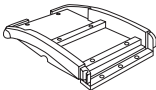
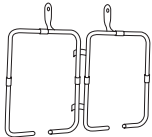
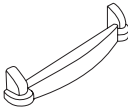

Optional (raffigurati in foto)

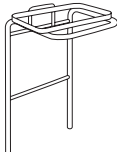
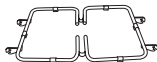
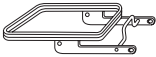

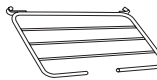

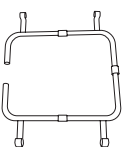
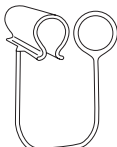





1610 Coperchio quadrato ●

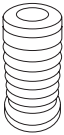
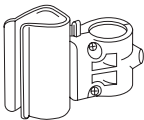
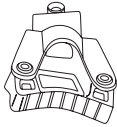
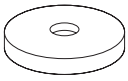

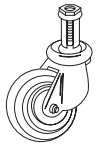
 83x52x105h cm |  1 Pz/cartone 12,6 Kg 0,225 m³

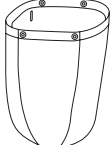
Optional

5051/R Coperchio per reggisacco duo ●

	Codice	Descrizione	Colore		Codice	Descrizione	Colore
	21001 B	Base IDEA senza ruote	●		GR5027/R	Reggisacco DUO 70 lt BIO-R in rilsan con clip fermasacco	
	21003 B	Finalino per base	●		GR8204	Reggisacco 70 lt JOKER con clip fermasacco	
	GR21016	Spalla diritta in rilsan IDEABASE con reggisacco e anello in gomma			GR8204/T	Reggisacco doppio JOKER TRIO con clip fermasacco	
	GR1620	Reggisacco multiuso con anello in gomma			1610 1611	Coperchio quadrato	● ●
	GR1725	Reggisacco X con anello in gomma			GR8206	Portasacco 70 lt JOKER	
	GR1725XE	Reggisacco estraibile XE con anello in gomma			1621	Clip fermasacco	●
	GR1728	Reggisacco SA/X con clip fermasacco			1701	Clip fermasacco con anello	●
	GR1731	Reggisacco SA/XT con anello elastico			1622	Anello in gomma grande	
	GR5013/R	Reggisacco 120 lt BIO-R in rilsan con clip fermasacco e attacco coperchio (art. 7031)			1712	Cestello portasecchi SA/X-SA/XT	

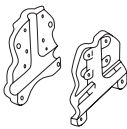
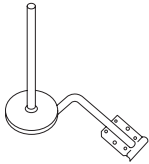
Codice	Descrizione	Colore	Codice	Descrizione	Colore
	1667 Cestello portaogetti X/XE			1696 Ruota fissa Ø 200 mm	
	1724 Tasca portaogetti nylon per X/XE			1432 Bussola per ruota con att. codulo (art. 1431)	
	KIT2230 Kit portamanico completo di aggancio Ø 22 mm	●		1694 Alberino HE per ruota fissa Ø 200 mm	
	2255 Portamanico in gomma con aggancio Ø 22 mm			1031 1032 Paracolpi piccolo	● ●
	1030 Ruota Ø 80 mm con filetto 8x28 e parafilo			1648 Vite con aletta plastica 6x15	
	1430 Ruota Ø 80 mm con espansore e parafilo			1680/G Sacco in cotone sanforizzato 230 lt	
	1431 Ruota Ø 80 mm att. codulo e parafilo			1685 Sacco nylon con occhielli 120 lt per XE	
	2034 Ruota Ø 100 mm con espansore e parafilo			1630 Astina intera multiuso	
	21008 Ruota in gomma naturale Ø 100 mm s/freno con filetto 10x15			1640 Astina filettata multiuso	

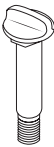
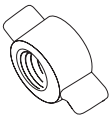
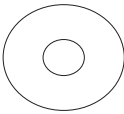
Codice	Descrizione	Colore
 KIT1735	Kit coppia flange plastica	●
 1750	Portarotolo con piastre fissaggio SA/X-SA/XT	
 21030 B	Tappo per base	●
 21035 B	Perno filettato	●
 21036	Ghiera filettata con alette	●
 4219	Rondella piana 6x24	



Multiuso Plastica Carenati

DMX

58

MX

76

Multiuso Plastica Carenati



Raccolta differenziata. Il reggisacchetto a doppio colore (blu/giallo) ed il cursore scorrevole dotato di due clip fermasacchetto con anello di tenuta permettono di organizzare agevolmente fino a tre sacchi per la raccolta differenziata dei rifiuti.



Facile conducibilità. Il movimento pivotante delle ruote, garantisce una facile conducibilità anche in situazioni critiche.



Sportelli e Sacchi. La coppia sportelli di chiusura e contenimento di uno, due o tre sacchi porta rifiuti è apribile a 90°. È possibile accessorizzare il carrello con sacchi in rete, in nylon o in PVC.





Facile sostituzione delle ruote. Nella base e nella prolunga, quando avviene lo stampo, vengono inserite a caldo delle bussole filettate in ottone che servono ad avvitare e fissare le ruote. Questo speciale sistema, adottato in Italia solo da VDM, permette una facile e rapida sostituzione delle ruote.



Cassetti. I cassetti della linea DMX possono essere aperti da entrambi i lati, permettendo a due operatori di lavorare agevolmente con un unico carrello. Sui cassetti, inoltre, è possibile alloggiare il coperchio ermetico e il dosatore Tecno-Shower.

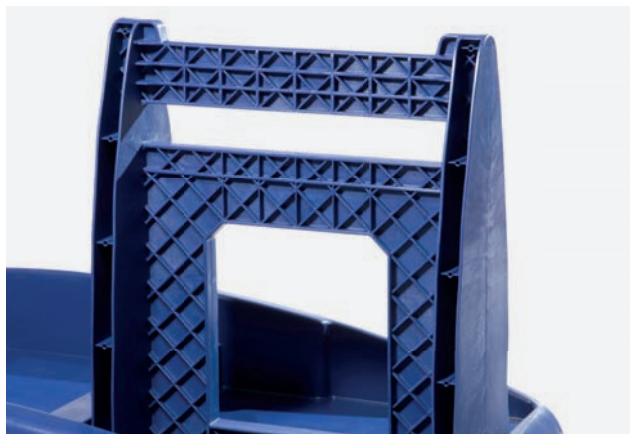

Materiali di prima qualità. Montanti in polipropilene copolimero rinforzati con barre in acciaio inox AISI 304. Portapressa 70% in polipropilene e 30% in fibra di vetro. Questo ha contribuito anche ad ottenere la massima stabilità in fase di strizzazione.



Sicurezza. Nelle versioni a due o tre cassetti della linea DMX è previsto un sistema di chiusura di tutta la cassetta, con un'unica serratura che blocca l'intera colonna.



Codice	Descrizione	Colore
DMX 201.2	Carrello multiuso in plastica carenato	
21001AB/DMX	1 Base IDEA/AB completa di 4 ruote morbide per esterno Ø 125 mm (art. 21027)	●
21003 B	1 Finalino per base	●
25050	1 Montante senza serratura DMX - 2 cassetti	●
25052	1 Montante con serratura DMX - 2 cassetti	●
25066 A	1 Cassetto 30 lt DMX	●
25066 R	1 Cassetto 30 lt DMX	●
2250 BA	1 Secchio 6 lt	●
2250 RA	1 Secchio 6 lt	●
23005 BA	1 Reggisacco MX/DMX completo di 4 portamanico, coperchio con leggio e cursore scorrevole	●
23004 B	1 Terminale MX/DMX completo di 3 portamanico	●
25064	2 Vaschette portachiacchi DMX	●
23003/1	1 Vaschetta portasecchi superiore MX/DMX	●
KITDMX/A	1 Kit montaggio DMX 201	●

Codice	Descrizione	Colore
DMX 201.3	Carrello multiuso in plastica carenato	
21001AB/DMX	1 Base IDEA/AB completa di 4 ruote morbide per esterno Ø 125 mm (art. 21027)	●
21003 B	1 Finalino per base	●
25051	1 Montante senza serratura DMX - 3 cassetti	●
25053	1 Montante con serratura DMX - 3 cassetti	●
25065 A	1 Cassetto 20 lt DMX	●
25065 G	1 Cassetto 20 lt DMX	●
25065 R	1 Cassetto 20 lt DMX	●
23020 G	1 Secchio 4 lt	●
23020 R	1 Secchio 4 lt	●
2250 BA	1 Secchio 6 lt	●
23005 BA	1 Reggisacco MX/DMX completo di 4 portamanico, coperchio con leggio e cursore scorrevole	●
23004 B	1 Terminale MX/DMX completo di 3 portamanico	●
25064	2 Vaschette portachiacchi DMX	●
23003/1	1 Vaschetta portasecchi superiore MX/DMX	●
KITDMX/A	1 Kit montaggio DMX 201	●

 83x56x105h cm |  1 Pz/cartone 25,5 Kg 0,400 m³

 83x56x105h cm |  1 Pz/cartone 26 Kg 0,400 m³



Codice	Descrizione	Colore
--------	-------------	--------

DMX 203.2 Carrello multiuso in plastica carenato

21001AB/COMPACT	1 Base IDEA/AB completa di 4 ruote morbide per esterno Ø 125 mm (art. 21027) e fermo sportelli	●
21003 B	1 Finalino per base	●
25050	1 Montante senza serratura DMX - 2 cassetti	●
25052	1 Montante con serratura DMX - 2 cassetti	●
23011N	1 Sportello sx MX/DMX	○
23012N	1 Sportello dx MX/DMX	○
25066 A	1 Cassetto 30 lt DMX	●
25066 R	1 Cassetto 30 lt DMX	●
2250 BA	1 Secchio 6 lt	●
2250 RA	1 Secchio 6 lt	●
23005 BA	1 Reggisacco MX/DMX completo di 4 portamanico, coperchio con leggio e cursore scorrevole	●
23004 B	1 Terminale MX/DMX completo di 3 portamanico	●
25064	2 Vaschette portachiaavi DMX	●
23003/1	1 Vaschetta portasecchi superiore MX/DMX	●
KITDMX/B	1 Kit montaggio DMX 203-204	●

Codice	Descrizione	Colore
--------	-------------	--------

DMX 203.3 Carrello multiuso in plastica carenato

21001AB/COMPACT	1 Base IDEA/AB completa di 4 ruote morbide per esterno Ø 125 mm (art. 21027) e fermo sportelli	●
21003 B	1 Finalino per base	●
25051	1 Montante senza serratura DMX - 3 cassetti	●
25053	1 Montante con serratura DMX - 3 cassetti	●
23011N	1 Sportello sx MX/DMX	○
23012N	1 Sportello dx MX/DMX	○
25065 A	1 Cassetto 20 lt DMX	●
25065 G	1 Cassetto 20 lt DMX	●
25065 R	1 Cassetto 20 lt DMX	●
23020 G	1 Secchio 4 lt	●
23020 R	1 Secchio 4 lt	●
2250 BA	1 Secchio 6 lt	●
23005 BA	1 Reggisacco MX/DMX completo di 4 portamanico, coperchio con leggio e cursore scorrevole	●
23004 B	1 Terminale MX/DMX completo di 3 portamanico	●
25064	2 Vaschette portachiaavi DMX	●
23003/1	1 Vaschetta portasecchi superiore MX/DMX	●
KITDMX/B	1 Kit montaggio DMX 203-204	●

 83x56x105h cm |  1 Pz/cartone 27,5 Kg 0,400 m³

 83x56x105hcm |  1 Pz/cartone 28 Kg 0,400 m³



Codice	Descrizione	Colore
DMX 204.2	Carrello multiuso in plastica carenato	
21001AB/COMPACT	1 Base IDEA/AB completa di 4 ruote morbide per esterno Ø 125 mm (art. 21027) e fermo sportelli	●
21003 B	1 Finalino per base	●
25050	1 Montante senza serratura DMX - 2 cassetti	●
25052	1 Montante con serratura DMX - 2 cassetti	●
23011N	1 Sportello sx MX/DMX	○
23012N	1 Sportello dx MX/DMX	○
25066 A	1 Cassetto 30 lt DMX	●
25066 R	1 Cassetto 30 lt DMX	●
2250 BA	1 Secchio 6 lt	●
2250 RA	1 Secchio 6 lt	●
7030 BA	1 Secchio rett. 22 lt	●
2252	2 Coperchi per secchio 6 lt	●
7038	1 Coperchio per secchio rett. 22 lt	●
23005 BA	1 Reggisacco MX/DMX completo di 4 portamanico, coperchio con leggio e cursore scorrevole	●
23004 B	1 Terminale MX/DMX completo di 3 portamanico	●
25064	2 Vaschette portachiavi DMX	●
23003/1	1 Vaschetta portasecchi superiore MX/DMX	●
23046	1 Cestello portasecchio 22 lt in rilsan MX/DMX	●
KITDMX/B	1 Kit montaggio DMX 203-204	●

Codice	Descrizione	Colore
DMX 204.3	Carrello multiuso in plastica carenato	
21001AB/COMPACT	1 Base IDEA/AB completa di 4 ruote morbide per esterno Ø 125 mm (art. 21027) e fermo sportelli	●
21003 B	1 Finalino per base	●
25051	1 Montante senza serratura DMX - 3 cassetti	●
25053	1 Montante con serratura DMX - 3 cassetti	●
23011N	1 Sportello sx MX/DMX	○
23012N	1 Sportello dx MX/DMX	○
25065 A	1 Cassetto 20 lt DMX	●
25065 G	1 Cassetto 20 lt DMX	●
25065 R	1 Cassetto 20 lt DMX	●
23020 G	1 Secchio 4 lt	●
23020 R	1 Secchio 4 lt	●
2250 BA	1 Secchio 6 lt	●
7030 BA	1 Secchio rett. 22 lt	●
2252	1 Coperchio per secchio 6 lt	●
7038	1 Coperchio per secchio rett. 22 lt	●
23005 BA	1 Reggisacco MX/DMX completo di 4 portamanico, coperchio con leggio e cursore scorrevole	●
23004 B	1 Terminale MX/DMX completo di 3 portamanico	●
25064	2 Vaschette portachiavi DMX	●
23003/1	1 Vaschetta portasecchi superiore MX/DMX	●
23046	1 Cestello portasecchio 22 lt in rilsan MX/DMX	●
KITDMX/B	1 Kit montaggio DMX 203-204	●

105x56x105h cm | 1 Pz/2 cartoni 31 Kg 0,450 m³

105x56x105h cm | 1 Pz/2 cartoni 31,5 Kg 0,450 m³



Codice	Descrizione	Colore
--------	-------------	--------

DMX 301.2 Carrello multiuso in plastica carenato

DMX 301.2 S/P Carrello multiuso in plastica carenato senza pressa

21001AB/DMX	1 Base IDEA/AB completa di 4 ruote morbide per esterno Ø 125 mm (art. 21027)	●
21002AB/DMX	1 Prolunga con ruota morbida per esterno Ø 125 mm (art. 21027)	●
25050	1 Montante senza serratura DMX - 2 cassetti	●
25052	1 Montante con serratura DMX - 2 cassetti	●
25066 A	1 Cassetto 30 lt DMX	●
25066 R	1 Cassetto 30 lt DMX	●
21005 BA	1 Secchio 15 lt IDEA	●
21005 RA	1 Secchio 15 lt IDEA	●
2250 BA	1 Secchio 6 lt	●
2250 RA	1 Secchio 6 lt	●
23005 BA	1 Reggisacco MX/DMX completo di 4 portamanico, coperchio con leggio e cursore scorrevole	●
23004 B	1 Terminale MX/DMX completo di 3 portamanico	●
25064	2 Vaschette portachiaavi DMX	●
23003/1	1 Vaschetta portasecchi superiore MX/DMX	●
23008	1 Portapressa IDEA in plastica con aggancio	●
4100PB	1 Strizzatore in plastica	●
KITDMX/C	1 Kit montaggio DMX 301	●

Codice	Descrizione	Colore
--------	-------------	--------

DMX 301.3 Carrello multiuso in plastica carenato

DMX 301.3 S/P Carrello multiuso in plastica carenato senza pressa

21001AB/DMX	1 Base IDEA/AB completa di 4 ruote morbide per esterno Ø 125 mm (art. 21027)	●
21002AB/DMX	1 Prolunga con ruota morbida per esterno Ø 125 mm (art. 21027)	●
25051	1 Montante senza serratura DMX - 3 cassetti	●
25053	1 Montante con serratura DMX - 3 cassetti	●
25065 A	1 Cassetto 20 lt DMX	●
25065 G	1 Cassetto 20 lt DMX	●
25065 R	1 Cassetto 20 lt DMX	●
21005 BA	1 Secchio 15 lt IDEA	●
21005 RA	1 Secchio 15 lt IDEA	●
2250 BA	1 Secchio 6 lt	●
2250 RA	1 Secchio 6 lt	●
23005 BA	1 Reggisacco MX/DMX completo di 4 portamanico, coperchio con leggio e cursore scorrevole	●
23004 B	1 Terminale MX/DMX completo di 3 portamanico	●
25064	2 Vaschette portachiaavi DMX	●
23003/1	1 Vaschetta portasecchi superiore MX/DMX	●
23008	1 Portapressa IDEA in plastica con aggancio	●
4100PB	1 Strizzatore in plastica	●
KITDMX/C	1 Kit montaggio DMX 301	●

110x56x105h cm	1 Pz/2 cartoni	29 Kg	0,520 m ³
	1 Pz/2 cartoni	26,5 Kg	0,520 m ³

110x56x105h cm	1 Pz/2 cartoni	29,5 Kg	0,520 m ³
	1 Pz/2 cartoni	27 Kg	0,520 m ³



Codice	Descrizione	Colore
--------	-------------	--------

DMX 303.2 Carrello multiuso in plastica carenato

DMX 303.2 S/P Carrello multiuso in plastica carenato senza pressa

21001AB/DMX	1 Base IDEA/AB completa di 4 ruote morbide per esterno Ø 125 mm (art. 21027)	●
21002IDEA/DMX	1 Prolunga con ruota morbida per esterno Ø 125 mm (art. 21027) e fermo sportelli	●
25050	1 Montante senza serratura DMX - 2 cassetti	●
25052	1 Montante con serratura DMX - 2 cassetti	●
23011N	1 Sportello sx MX/DMX	○
23012N	1 Sportello dx MX/DMX	○
25066 A	1 Cassetto 30 lt DMX	●
25066 R	1 Cassetto 30 lt DMX	●
21005 BA	1 Secchio 15 lt IDEA	●
21005 RA	1 Secchio 15 lt IDEA	●
2250 BA	1 Secchio 6 lt	●
2250 RA	1 Secchio 6 lt	●
23005 BA	1 Reggisacco MX/DMX completo di 4 portamanico, coperchio con leggio e cursore scorrevole	●
23004 B	1 Terminale MX/DMX completo di 3 portamanico	●
25064	2 Vaschette portachiacchi DMX	●
23003/1	1 Vaschetta portasecchi superiore MX/DMX	●
23008	1 Portapressa IDEA in plastica con aggancio	●
4100PB	1 Strizzatore in plastica	●
KITDMX/D	1 Kit montaggio DMX 303	●

Codice	Descrizione	Colore
--------	-------------	--------

DMX 303.3 Carrello multiuso in plastica carenato

DMX 303.3 S/P Carrello multiuso in plastica carenato senza pressa

21001AB/DMX	1 Base IDEA/AB completa di 4 ruote morbide per esterno Ø 125 mm (art. 21027)	●
21002IDEA/DMX	1 Prolunga con ruota morbida per esterno Ø 125 mm (art. 21027) e fermo sportelli	●
25051	1 Montante senza serratura DMX - 3 cassetti	●
25053	1 Montante con serratura DMX - 3 cassetti	●
23011N	1 Sportello sx MX/DMX	○
23012N	1 Sportello dx MX/DMX	○
25065 A	1 Cassetto 20 lt DMX	●
25065 G	1 Cassetto 20 lt DMX	●
25065 R	1 Cassetto 20 lt DMX	●
21005 BA	1 Secchio 15 lt IDEA	●
21005 RA	1 Secchio 15 lt IDEA	●
2250 BA	1 Secchio 6 lt	●
2250 RA	1 Secchio 6 lt	●
23005 BA	1 Reggisacco MX/DMX completo di 4 portamanico, coperchio con leggio e cursore scorrevole	●
23004 B	1 Terminale MX/DMX completo di 3 portamanico	●
25064	2 Vaschette portachiacchi DMX	●
23003/1	1 Vaschetta portasecchi superiore MX/DMX	●
23008	1 Portapressa IDEA in plastica con aggancio	●
4100PB	1 Strizzatore in plastica	●
KITDMX/D	1 Kit montaggio DMX 303	●

110x56x105h cm	1 Pz/2 cartoni	36,5 Kg	0,520 m ³
	1 Pz/2 cartoni	34 Kg	0,520 m ³

110x56x105h cm	1 Pz/2 cartoni	37 Kg	0,520 m ³
	1 Pz/2 cartoni	34,5 Kg	0,520 m ³



Codice	Descrizione	Colore
--------	-------------	--------

DMX 304.2 Carrello multiuso in plastica carenato

21001AB/DMX	1 Base IDEA/AB completa di 4 ruote morbide per esterno Ø 125 mm (art. 21027)	●
21002IDEA/DMX	1 Prolunga con ruota morbida per esterno Ø 125 mm (art. 21027) e fermo sportelli	●
25050	1 Montante senza serratura DMX - 2 cassetti	●
25052	1 Montante con serratura DMX - 2 cassetti	●
23011N	1 Sportello sx MX/DMX	○
23012N	1 Sportello dx MX/DMX	○
25066 A	1 Cassetto 30 lt DMX	●
25066 R	1 Cassetto 30 lt DMX	●
23020 G	1 Secchio 4 lt	●
23020 R	1 Secchio 4 lt	●
2250 BA	1 Secchio 6 lt	●
7030 RA	1 Secchio rett. 22 lt	●
7038	1 Coperchio per secchio rett. 22 lt	●
23005 BA	1 Reggisacco MX/DMX completo di 4 portamanico, coperchio con leggio e cursore scorrevole	●
23004 B	1 Terminale MX/DMX completo di 3 portamanico	●
25064	2 Vaschette portachiacchi DMX	●
23003/1	1 Vaschetta portasecchi superiore MX/DMX	●
KITDMX/E	1 Kit montaggio DMX 304-305-501	●

Codice	Descrizione	Colore
--------	-------------	--------

DMX 304.3 Carrello multiuso in plastica carenato

21001AB/DMX	1 Base IDEA/AB completa di 4 ruote morbide per esterno Ø 125 mm (art. 21027)	●
21002IDEA/DMX	1 Prolunga con ruota morbida per esterno Ø 125 mm (art. 21027) e fermo sportelli	●
25051	1 Montante senza serratura DMX - 3 cassetti	●
25053	1 Montante con serratura DMX - 3 cassetti	●
23011N	1 Sportello sx MX/DMX	○
23012N	1 Sportello dx MX/DMX	○
25065 A	1 Cassetto 20 lt DMX	●
25065 G	1 Cassetto 20 lt DMX	●
25065 R	1 Cassetto 20 lt DMX	●
23020 G	1 Secchio 4 lt	●
23020 R	1 Secchio 4 lt	●
2250 BA	1 Secchio 6 lt	●
7030 RA	1 Secchio rett. 22 lt	●
7038	1 Coperchio per secchio rett. 22 lt	●
23005 BA	1 Reggisacco MX/DMX completo di 4 portamanico, coperchio con leggio e cursore scorrevole	●
23004 B	1 Terminale MX/DMX completo di 3 portamanico	●
25064	2 Vaschette portachiacchi DMX	●
23003/1	1 Vaschetta portasecchi superiore MX/DMX	●
KITDMX/E	1 Kit montaggio DMX 304-305-501	●

110x56x105h cm | 1 Pz/2 cartoni 29 Kg 0,520 m³

110x56x105h cm | 1 Pz/2 cartoni 29,5 Kg 0,520 m³



Codice	Descrizione	Colore
--------	-------------	--------

DMX 305.2 Carrello multiuso in plastica carenato

DMX 305.2 S/P Carrello multiuso in plastica carenato senza pressa

21001AB/DMX	1 Base IDEEA/AB completa di 4 ruote morbide per esterno Ø 125 mm (art. 21027)	●
21002IDEA/DMX	1 Prolunga con ruota morbida per esterno Ø 125 mm (art. 21027) e fermo sportelli	●
25050	1 Montante senza serratura DMX - 2 cassetti	●
25052	1 Montante con serratura DMX - 2 cassetti	●
23011N	1 Sportello sx MX/DMX	○
23012N	1 Sportello dx MX/DMX	○
25066 A	1 Cassetto 30 lt DMX	●
25066 R	1 Cassetto 30 lt DMX	●
2250 BA	1 Secchio 6 lt	●
2250 RA	1 Secchio 6 lt	●
23005 BA	1 Reggisacco MX/DMX completo di 4 portamanico, coperchio con leggio e cursore scorrevole	●
23004 B	1 Terminale MX/DMX completo di 3 portamanico	●
25064	2 Vaschette portachiavi DMX	●
23003/1	1 Vaschetta portasecchi superiore MX/DMX	●
MAC 50G+P	1 Secchio carrellato in plastica mono 20 lt	●
4635	1 Secchio 8 lt	●
KITDMX/E	1 Kit montaggio DMX 304-305-501	●

Codice	Descrizione	Colore
--------	-------------	--------

DMX 305.3 Carrello multiuso in plastica carenato

DMX 305.3 S/P Carrello multiuso in plastica carenato senza pressa

21001AB/DMX	1 Base IDEEA/AB completa di 4 ruote morbide per esterno Ø 125 mm (art. 21027)	●
21002IDEA/DMX	1 Prolunga con ruota morbida per esterno Ø 125 mm (art. 21027) e fermo sportelli	●
25051	1 Montante senza serratura DMX - 3 cassetti	●
25053	1 Montante con serratura DMX - 3 cassetti	●
23011N	1 Sportello sx MX/DMX	○
23012N	1 Sportello dx MX/DMX	○
25065 A	1 Cassetto 20 lt DMX	●
25065 G	1 Cassetto 20 lt DMX	●
25065 R	1 Cassetto 20 lt DMX	●
23020 G	1 Secchio 4 lt	●
23020 R	1 Secchio 4 lt	●
2250 BA	1 Secchio 6 lt	●
23005 BA	1 Reggisacco MX/DMX completo di 4 portamanico, coperchio con leggio e cursore scorrevole	●
23004 B	1 Terminale MX/DMX completo di 3 portamanico	●
25064	2 Vaschette portachiavi DMX	●
23003/1	1 Vaschetta portasecchi superiore MX/DMX	●
MAC 50G+P	1 Secchio carrellato in plastica mono 20 lt	●
4635	1 Secchio 8 lt	●
KITDMX/E	1 Kit montaggio DMX 304-305-501	●

110x56x105h cm	1 Pz/2 cartoni	31 Kg	0,520 m ³
	1 Pz/2 cartoni	28,5 Kg	0,520 m ³

110x56x105h cm	1 Pz/2 cartoni	31,5 Kg	0,520 m ³
	1 Pz/2 cartoni	29 Kg	0,520 m ³



Codice	Descrizione	Colore
--------	-------------	--------

DMX 401.2 Carrello multiuso in plastica carenato

21001AB/DMX	1 Base IDEA/AB completa di 4 ruote morbide per esterno Ø 125 mm (art. 21027)	●
21002AB/DMX	1 Prolunga con ruota morbida per esterno Ø 125 mm (art. 21027)	●
25050	1 Montante senza serratura DMX - 2 cassetti	●
25052	1 Montante con serratura DMX - 2 cassetti	●
25066 A	1 Cassetto 30 lt DMX	●
25066 R	1 Cassetto 30 lt DMX	●
2250 BA	1 Secchio 6 lt	●
2250 RA	1 Secchio 6 lt	●
23005 BA	2 Reggisacco MX/DMX completi di 4 portamanico, coperchio con leggio e cursore scorrevole	●
25064	2 Vaschette portachiaavi DMX	●
23003/1	1 Vaschetta portasecchi superiore MX/DMX	●
1677 B	1 Sacco nylon 120 lt (72x100 cm)	●
1677 R	1 Sacco nylon 120 lt (72x100 cm)	●
KITDMX/F	1 Kit montaggio DMX 401	●

Codice	Descrizione	Colore
--------	-------------	--------

DMX 401.3 Carrello multiuso in plastica carenato

21001AB/DMX	1 Base IDEA/AB completa di 4 ruote morbide per esterno Ø 125 mm (art. 21027)	●
21002AB/DMX	1 Prolunga con ruota morbida per esterno Ø 125 mm (art. 21027)	●
25051	1 Montante senza serratura DMX - 3 cassetti	●
25053	1 Montante con serratura DMX - 3 cassetti	●
25065 A	1 Cassetto 20 lt DMX	●
25065 G	1 Cassetto 20 lt DMX	●
25065 R	1 Cassetto 20 lt DMX	●
23020 G	1 Secchio 4 lt	●
23020 R	1 Secchio 4 lt	●
2250 BA	1 Secchio 6 lt	●
23005 BA	2 Reggisacco MX/DMX completi di 4 portamanico, coperchio con leggio e cursore scorrevole	●
25064	2 Vaschette portachiaavi DMX	●
23003/1	1 Vaschetta portasecchi superiore MX/DMX	●
1677 B	1 Sacco nylon 120 lt (72x100 cm)	●
1677 R	1 Sacco nylon 120 lt (72x100 cm)	●
KITDMX/F	1 Kit montaggio DMX 401	●

 110x56x105h cm |  1 Pz/2 cartoni 26,5 Kg 0,410 m³

 110x56x105h cm |  1 Pz/2 cartoni 27 Kg 0,410 m³



Codice	Descrizione	Colore
DMX 403.2	Carrello multiuso in plastica carenato	
21001AB/DMX	1 Base IDEA/AB completa di 4 ruote morbide per esterno Ø 125 mm (art. 21027)	●
21002IDEA/DMX	1 Prolunga con ruota morbida per esterno Ø 125 mm (art. 21027) e fermo sportelli	●
25050	1 Montante senza serratura DMX - 2 cassetti	
25052	1 Montante con serratura DMX - 2 cassetti	
23011N	2 Sportelli sx MX/DMX	○
23012N	2 Sportelli dx MX/DMX	○
25066 A	1 Cassetto 30 lt DMX	●
25066 R	1 Cassetto 30 lt DMX	●
2250 BA	1 Secchio 6 lt	●
2250 RA	1 Secchio 6 lt	●
23005 BA	2 Reggisacco MX/DMX completi di 4 portamanico, coperchio con leggio e cursore scorrevole	●
25064	2 Vaschette portachiavi DMX	●
23003/1	1 Vaschetta portasecchi superiore MX/DMX	●
1677 B	1 Sacco nylon 120 lt (72x100 cm)	●
1677 R	1 Sacco nylon 120 lt (72x100 cm)	●
KITDMX/G	1 Kit montaggio DMX 403	●

Codice	Descrizione	Colore
DMX 403.3	Carrello multiuso in plastica carenato	
21001AB/DMX	1 Base IDEA/AB completa di 4 ruote morbide per esterno Ø 125 mm (art. 21027)	●
21002IDEA/DMX	1 Prolunga con ruota morbida per esterno Ø 125 mm (art. 21027) e fermo sportelli	●
25051	1 Montante senza serratura DMX - 3 cassetti	
25053	1 Montante con serratura DMX - 3 cassetti	
23011N	2 Sportelli sx MX/DMX	○
23012N	2 Sportelli dx MX/DMX	○
25065 A	1 Cassetto 20 lt DMX	●
25065 G	1 Cassetto 20 lt DMX	●
25065 R	1 Cassetto 20 lt DMX	●
23020 G	1 Secchio 4 lt	●
23020 R	1 Secchio 4 lt	●
2250 BA	1 Secchio 6 lt	●
23005 BA	2 Reggisacco MX/DMX completi di 4 portamanico, coperchio con leggio e cursore scorrevole	●
25064	2 Vaschette portachiavi DMX	●
23003/1	1 Vaschetta portasecchi superiore MX/DMX	●
1677 B	1 Sacco nylon 120 lt (72x100 cm)	●
1677 R	1 Sacco nylon 120 lt (72x100 cm)	●
KITDMX/G	1 Kit montaggio DMX 403	●

 110x56x105h cm |  1 Pz/3 cartoni 34,5 Kg 0,540 m³

 110x56x105h cm |  1 Pz/3 cartoni 35 Kg 0,540 m³



Codice	Descrizione	Colore
--------	-------------	--------

DMX 500.2.20 Carrello multiuso in plastica carenato

21001AB/DMX	1 Base IDEA/AB completa di 4 ruote morbide per esterno Ø 125 mm (art. 21027)	●
21002IDEA/DMX	1 Prolunga con ruota morbida per esterno Ø 125 mm (art. 21027) e fermo sportelli	●
25050	1 Montante senza serratura DMX - 2 cassetti	●
25052	1 Montante con serratura DMX - 2 cassetti	●
23011N	1 Sportello sx MX/DMX	○
23012N	1 Sportello dx MX/DMX	○
25066 A	1 Cassetto 30 lt DMX	●
25066 R	1 Cassetto 30 lt DMX	●
25066/P	2 Cassetti 20 lt con paracolpi	●
23020 G	1 Secchio 4 lt	●
23020 R	1 Secchio 4 lt	●
2250 BA	1 Secchio 6 lt	●
23005 BA	1 Reggisacco MX/DMX completo di 4 portamanico, coperchio con leggio e cursore scorrevole	●
23004 B	1 Terminale MX/DMX completo di 3 portamanico	●
25064	2 Vaschette portachiaavi DMX	●
23003/1	1 Vaschetta portasecchi superiore MX/DMX	●
GR23085	1 Portasecchio 22 lt in rilsan MX/DMX	●
KITDMX/H	1 Kit montaggio DMX 500	●

Codice	Descrizione	Colore
--------	-------------	--------

DMX 500.2.30 Carrello multiuso in plastica carenato

21001AB/DMX	1 Base IDEA/AB completa di 4 ruote morbide per esterno Ø 125 mm (art. 21027)	●
21002IDEA/DMX	1 Prolunga con ruota morbida per esterno Ø 125 mm (art. 21027) e fermo sportelli	●
25050	1 Montante senza serratura DMX - 2 cassetti	●
25052	1 Montante con serratura DMX - 2 cassetti	●
23011N	1 Sportello sx MX/DMX	○
23012N	1 Sportello dx MX/DMX	○
25066 A	1 Cassetto 30 lt DMX	●
25066 R	1 Cassetto 30 lt DMX	●
25066/P	2 Cassetti 30 lt con paracolpi	●
23020 G	1 Secchio 4 lt	●
23020 R	1 Secchio 4 lt	●
2250 BA	1 Secchio 6 lt	●
23005 BA	1 Reggisacco MX/DMX completo di 4 portamanico, coperchio con leggio e cursore scorrevole	●
23004 B	1 Terminale MX/DMX completo di 3 portamanico	●
25064	2 Vaschette portachiaavi DMX	●
23003/1	1 Vaschetta portasecchi superiore MX/DMX	●
GR23085	1 Portasecchio 22 lt in rilsan MX/DMX	●
KITDMX/H	1 Kit montaggio DMX 500	●

110x56x105h cm | 1 Pz/2 cartoni 36,5 Kg 0,520 m³

110x56x105h cm | 1 Pz/2 cartoni 37 Kg 0,520 m³



Codice	Descrizione	Colore
DMX 500.3.20	Carrello multiuso in plastica carenato	
21001AB/DMX	1 Base IDEA/AB completa di 4 ruote morbide per esterno Ø 125 mm (art. 21027)	●
21002IDEA/DMX	1 Prolunga con ruota morbida per esterno Ø 125 mm (art. 21027) e fermo sportelli	●
25051	1 Montante senza serratura DMX - 3 cassetti	●
25053	1 Montante con serratura DMX - 3 cassetti	●
23011N	1 Sportello sx MX/DMX	○
23012N	1 Sportello dx MX/DMX	○
25065 A	1 Cassetto 20 lt DMX	●
25065 G	1 Cassetto 20 lt DMX	●
25065 R	1 Cassetto 20 lt DMX	●
25065/P	2 Cassetti 20 lt con paracolpi	●
23020 G	1 Secchio 4 lt	●
23020 R	1 Secchio 4 lt	●
2250 BA	1 Secchio 6 lt	●
23005 BA	1 Reggisacco MX/DMX completo di 4 portamanico, coperchio con leggio e cursore scorrevole	●
23004 B	1 Terminale MX/DMX completo di 3 portamanico	●
25064	2 Vaschette portachiaavi DMX	●
23003/1	1 Vaschetta portasecchi superiore MX/DMX	●
GR23085	1 Portasecchio 22 lt in rilsan MX/DMX	
KITDMX/H	1 Kit montaggio DMX 500	

Codice	Descrizione	Colore
DMX 500.3.30	Carrello multiuso in plastica carenato	
21001AB/DMX	1 Base IDEA/AB completa di 4 ruote morbide per esterno Ø 125 mm (art. 21027)	●
21002IDEA/DMX	1 Prolunga con ruota morbida per esterno Ø 125 mm (art. 21027) e fermo sportelli	●
25051	1 Montante senza serratura DMX - 3 cassetti	●
25053	1 Montante con serratura DMX - 3 cassetti	●
23011N	1 Sportello sx MX/DMX	○
23012N	1 Sportello dx MX/DMX	○
25065 A	1 Cassetto 20 lt DMX	●
25065 G	1 Cassetto 20 lt DMX	●
25065 R	1 Cassetto 20 lt DMX	●
25066/P	2 Cassetti 30 lt con paracolpi	●
23020 G	1 Secchio 4 lt	●
23020 R	1 Secchio 4 lt	●
2250 BA	1 Secchio 6 lt	●
23005 BA	1 Reggisacco MX/DMX completo di 4 portamanico, coperchio con leggio e cursore scorrevole	●
23004 B	1 Terminale MX/DMX completo di 3 portamanico	●
25064	2 Vaschette portachiaavi DMX	●
23003/1	1 Vaschetta portasecchi superiore MX/DMX	●
GR23085	1 Portasecchio 22 lt in rilsan MX/DMX	
KITDMX/H	1 Kit montaggio DMX 500	

 110x56x105h cm |  1 Pz/2 cartoni 37 Kg 0,520 m³

 110x56x105h cm |  1 Pz/2 cartoni 37,5 Kg 0,520 m³



Codice	Descrizione	Colore
--------	-------------	--------

DMX 500.2 Carrello multiuso in plastica carenato

21001AB/DMX	1 Base IDEA/AB completa di 4 ruote morbide per esterno Ø 125 mm (art. 21027)	●
21002IDEA/DMX	1 Prolunga con ruota morbida per esterno Ø 125 mm (art. 21027) e fermo sportelli	●
25050	1 Montante senza serratura DMX - 2 cassetti	●
25052	1 Montante con serratura DMX - 2 cassetti	●
23011N	1 Sportello sx MX/DMX	○
23012N	1 Sportello dx MX/DMX	○
25066 A	1 Cassetto 30 lt DMX	●
25066 R	1 Cassetto 30 lt DMX	●
23020 G	1 Secchio 4 lt	●
23020 R	1 Secchio 4 lt	●
2250 BA	1 Secchio 6 lt	●
7030 BA	1 Secchio rett. 22 lt	●
7030 RA	1 Secchio rett. 22 lt	●
7038	2 Coperchi per secchio rett. 22 lt	●
23005 BA	1 Reggisacco MX/DMX completo di 4 portamanico, coperchio con leggio e cursore scorrevole	●
23004 B	1 Terminale MX/DMX completo di 3 portamanico	●
25064	2 Vaschette portachiaavi DMX	●
23003/1	1 Vaschetta portasecchi superiore MX/DMX	●
GR23085	1 Portasecchio 22 lt in rilsan MX/DMX	●
7080	1 Dosatore Tecno-Shower	●
KITDMX/H	1 Kit montaggio DMX 500	●

Codice	Descrizione	Colore
--------	-------------	--------

DMX 500.3 Carrello multiuso in plastica carenato

21001AB/DMX	1 Base IDEA/AB completa di 4 ruote morbide per esterno Ø 125 mm (art. 21027)	●
21002IDEA/DMX	1 Prolunga con ruota morbida per esterno Ø 125 mm (art. 21027) e fermo sportelli	●
25051	1 Montante senza serratura DMX - 3 cassetti	●
25053	1 Montante con serratura DMX - 3 cassetti	●
23011N	1 Sportello sx MX/DMX	○
23012N	1 Sportello dx MX/DMX	○
25065 A	1 Cassetto 20 lt DMX	●
25065 G	1 Cassetto 20 lt DMX	●
25065 R	1 Cassetto 20 lt DMX	●
23020 G	1 Secchio 4 lt	●
23020 R	1 Secchio 4 lt	●
2250 BA	1 Secchio 6 lt	●
7030 BA	1 Secchio rett. 22 lt	●
7030 RA	1 Secchio rett. 22 lt	●
7038	2 Coperchi per secchio rett. 22 lt	●
23005 BA	1 Reggisacco MX/DMX completo di 4 portamanico, coperchio con leggio e cursore scorrevole	●
23004 B	1 Terminale MX/DMX completo di 3 portamanico	●
25064	2 Vaschette portachiaavi DMX	●
23003/1	1 Vaschetta portasecchi superiore MX/DMX	●
GR23085	1 Portasecchio 22 lt in rilsan MX/DMX	●
7080	1 Dosatore Tecno-Shower	●
KITDMX/H	1 Kit montaggio DMX 500	●

 110x56x105h cm |  1 Pz/2 cartoni 36,5 Kg 0,520 m³

 110x56x105h cm |  1 Pz/2 cartoni 37 Kg 0,520 m³













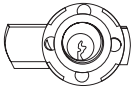
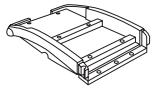

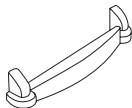

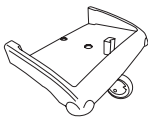

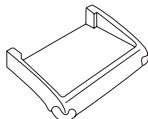

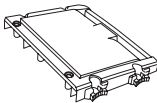

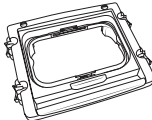
Codice	Descrizione	Colore
DMX 501.2	Carrello multiuso in plastica carenato	
21001AB/DMX	1 Base IDEA/AB completa di 4 ruote morbide per esterno Ø 125 mm (art. 21027)	●
21002IDEA/DMX	1 Prolunga con ruota morbida per esterno Ø 125 mm (art. 21027) e fermo sportelli	●
25050	1 Montante senza serratura DMX - 2 cassetti	
25052	1 Montante con serratura DMX - 2 cassetti	
23011N	1 Sportello sx MX/DMX	○
23012N	1 Sportello dx MX/DMX	○
25066 A	1 Cassetto 30 lt DMX	●
25066 R	1 Cassetto 30 lt DMX	●
23020 G	1 Secchio 4 lt	●
23020 R	1 Secchio 4 lt	●
2250 BA	1 Secchio 6 lt	●
7030 BA	1 Secchio rett. 22 lt	●
7030 RA	1 Secchio rett. 22 lt	●
7038	2 Coperchi per secchio rett. 22 lt	●
23005 BA	1 Reggisacco MX/DMX completo di 4 portamanico, coperchio con leggio e cursore scorrevole	●
23004 B	1 Terminale MX/DMX completo di 3 portamanico	●
25064	2 Vaschette portachiacchi DMX	●
23003/1	1 Vaschetta portasecchi superiore MX/DMX	●
GR23078	1 Telaio rilsan carrello porta secchi	●
7080	1 Dosatore Tecno-Shower	●
KITDMX/E	1 Kit montaggio DMX 304-305-501	●

Codice	Descrizione	Colore
DMX 501.3	Carrello multiuso in plastica carenato	
21001AB/DMX	1 Base IDEA/AB completa di 4 ruote morbide per esterno Ø 125 mm (art. 21027)	●
21002IDEA/DMX	1 Prolunga con ruota morbida per esterno Ø 125 mm (art. 21027) e fermo sportelli	●
25051	1 Montante senza serratura DMX - 3 cassetti	
25053	1 Montante con serratura DMX - 3 cassetti	
23011N	1 Sportello sx MX/DMX	○
23012N	1 Sportello dx MX/DMX	○
25065 A	1 Cassetto 20 lt DMX	●
25065 G	1 Cassetto 20 lt DMX	●
25065 R	1 Cassetto 20 lt DMX	●
23020 G	1 Secchio 4 lt	●
23020 R	1 Secchio 4 lt	●
2250 BA	1 Secchio 6 lt	●
7030 BA	1 Secchio rett. 22 lt	●
7030 RA	1 Secchio rett. 22 lt	●
7038	2 Coperchi per secchio rett. 22 lt	●
23005 BA	1 Reggisacco MX/DMX completo di 4 portamanico, coperchio con leggio e cursore scorrevole	●
23004 B	1 Terminale MX/DMX completo di 3 portamanico	●
25064	2 Vaschette portachiacchi DMX	●
23003/1	1 Vaschetta portasecchi superiore MX/DMX	●
GR23078	1 Telaio rilsan carrello porta secchi	●
7080	1 Dosatore Tecno-Shower	●
KITDMX/E	1 Kit montaggio DMX 304-305-501	●

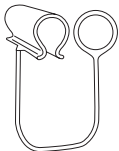
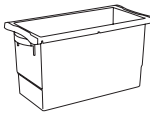

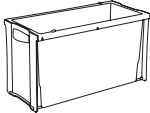
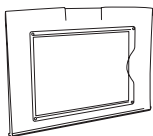
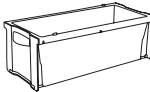
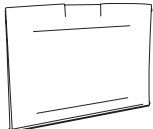

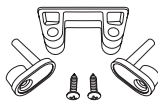
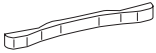
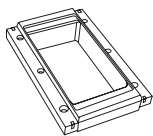
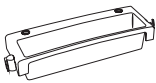
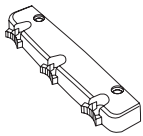
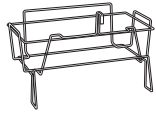
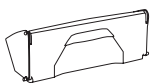

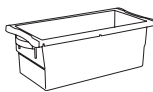
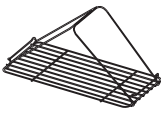

110x56x105h cm | 1 Pz/2 cartoni 38 Kg 0,660 m³

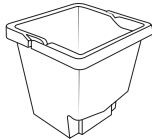

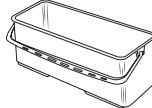
110x56x105h cm | 1 Pz/2 cartoni 38,5 Kg 0,660 m³

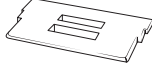
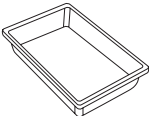
Codice	Descrizione	Colore	Codice	Descrizione	Colore
 21001 AB/DMX	Base IDEA/AB completa di 4 ruote morbide per esterno Ø 125 mm (art. 21027)	●	 25051	Montante senza serratura DMX - 3 cassetti	
 21001 AB/COMPACT	Base IDEA/AB completa di 4 ruote morbide per esterno Ø 125 mm (art. 21027) e fermo sportelli	●	 23013	Serratura per MX-DMX	
 21001 VS	Base IDEA/AB senza ruote	●	 23014	Chiave per serrature MX e DMX	
 21003 B	Finalino per base	●	 23011N	Sportello sx MX/DMX	○
 21002 IDEA/DMX	Prolunga con ruota morbida per esterno Ø 125 mm (art. 21027) e fermo sportelli	●	 23012N	Sportello dx MX/DMX	○
 21002 B	Prolunga senza ruota per base	●	 23010 N	Coppia sportelli MX/DMX	○
 25052	Montante con serratura DMX - 2 cassetti		 23005 BA	Reggisacco MX/DMX completo di 4 portamanico, coperchio con leggio e cursore scorrevole	●
 25053	Montante con serratura DMX - 3 cassetti		 23005/100B	Reggisacco MX/DMX senza coperchio completo di 4 portamanico	●
 25050	Montante senza serratura DMX - 2 cassetti		 23100	Portarotolo per reggisacco plastica	

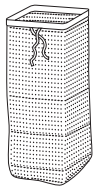
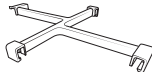
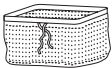
Codice	Descrizione	Colore	Codice	Descrizione	Colore
	1701 Clip fermasacco con anello	●		25066/P Cassetto 30 lt con paracolpi	
	2709 Separatore con clip per reggisacco plastica	●		25066 A 25066 G 25066 R 25066 V Cassetto 30 lt DMX	● ● ● ●
	23006 B Coperchio con leggio per reggisacco plastica	●		25065 A 25065 G 25065 R 25065 V Cassetto 20 lt DMX	● ● ● ●
	23006/N Coperchio senza leggio per reggisacco plastica	●		25060 Coperchio per cassette	●
	KIT23030 Kit portamanico in gomma			25067 Paracolpi cassetto	○
	23003/1 Vaschetta portasecchi superiore MX/DMX	●		23024 Cestello portasecchi in plastica con portamanico e gancio MX/DMX	●
	23004 B Terminale MX/DMX completo di 3 portamanico	●		23046 Cestello portasecchio 22 lt in rilsan MX/DMX	
	25064 Vaschetta portachiavi DMX	●		2231/G Gancio senza aggancio	●
	25065/P Cassetto 20 lt con paracolpi			7032 Griglia inox pieghevole (per secchio rett. 22 lt)	

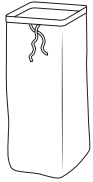
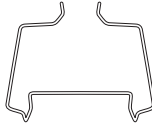
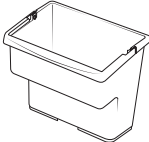
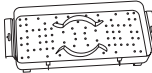
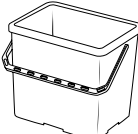
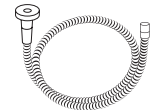
Codice	Descrizione	Colore	Codice	Descrizione	Colore
	4260/1 Pannello segnalatore <small>(PAVIMENTO SCIIVOLOSO / PAVIMENTO BAGNATO)</small>			24060 Ruota Ø 100 mm con filetto 10x15	
	21035 B Perno filettato	●		24061 Ruota Ø 100 mm XL s/freno con filetto 10x15	
	2230/DMX Portamanico senza aggancio per cestello portaflaconi	○		24062 Ruota Ø 100 mm XL c/freno con filetto 10x15	
	23008 Portapressa IDEA in plastica con aggancio	●		21012 Ruota Ø 125 mm s/freno con filetto 10x15	
	GR23085 Portasecchio 22 lt in rilsan MX/DMX			21013 Ruota Ø 125 mm c/freno con filetto 10x15	
	23000 KIT Kit estensione portavassoio in rilsan composto da: - estensione rilsan - vassoio pl MX (art. 23015 GR)			21008 Ruota in gomma naturale Ø 100 mm s/freno con filetto 10x15	
	23023 KIT Kit portasecchi 2x4lt rilsan composto da: - cestello portasecchi 2x4lt rilsan - cerniera inox dx (art. 23070), sx (art. 23071) - 4 viti autofilettanti inox 4,2x16 (art. 4221)			21009 Ruota in gomma naturale Ø 100 mm c/freno con filetto 10x15	
	23016 KIT Kit ripiano portavassoio rilsan composto da: - ripiano portavassoio rilsan (art. 23016) - vassoio pl. centrale MX (art. 23015 GR)			21006 Ruota in gomma naturale Ø 125 mm s/freno con filetto 10x15	
	24057 KIT Kit VELBOX rilsan composto da: - supporto VELBOX in rilsan - cerniera inox dx (art. 23070), sx (art. 23071) - 4 viti autofilettanti inox 4,2x16 (art. 4221)			21007 Ruota in gomma naturale Ø 125 mm c/freno con filetto 10x15	

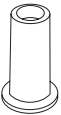
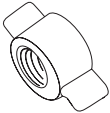
Codice	Descrizione	Colore	Codice	Descrizione	Colore
	21027 Ruota morbida per esterno Ø 125 mm			21005 BA 21005 RA Secchio 15 lt IDEA	● ●
	21028 Ruota morbida per esterno Ø 125 mm spec s/freno (Abbinabile solo con cod. 21029)			7030 BA 7030 RA Secchio rett. 22 lt	● ●
	21029 Ruota morbida per esterno Ø 125 mm spec c/freno (Abbinabile solo con cod. 21028)			23021 Coperchio per secchio 4 lt	●
	23015 GR Vassoio MX	●		2252 Coperchio per secchio 6 lt	●
	23095 Sacco in rete 70 lt con laccio di chiusura			2253 Separatore flaconi per secchio 6 lt	●
	23097 Sacco in rete per secchio 22 lt con laccio di chiusura			7038 Coperchio per secchio rett. 22 lt	●
	1677 B 1677 R Sacco nylon 120 lt (72x100 cm)	● ●		7079 Supporto in rilsan per dosatore Tecno-Shower	
	23020 B 23020 G 23020 R 23020 VS Secchio 4 lt	● ● ● ●		7080 Dosatore Tecno-Shower	●
	2250 BA 2250 G 2250 RA 2250 VS Secchio 6 lt	● ● ● ●		1071 Convogliatore acqua FAST	

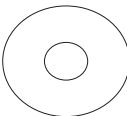
Codice	Descrizione	Colore
 3501 VDM	Strizzatore a rullo ELPAROLL	
 4100PB	Strizzatore in plastica	●
 21030 B	Tappo per base	●
 21036	Ghiera filettata con alette	●
 1648	Vite con aletta plastica 6x15	
 4219	Rondella piana 6x24	



Codice	Descrizione	Colore
MX 100	Carrello multiuso in plastica carenato	
MX 100 S/P	Carrello multiuso in plastica carenato senza pressa	
21001IDEA/PL	1 Base IDEA completa di 4 ruote Ø 100 mm (art. 24060)	●
21003 B	1 Finalino per base	●
23002/100	1 Spalla MX 100	○
23020 G	1 Secchio 4 lt	●
23020 R	1 Secchio 4 lt	●
21005 B	1 Secchio 15 lt IDEA	●
21005 R	1 Secchio 15 lt IDEA	●
23005/100 B	1 Reggisacco MX/DMX senza coperchio completo di 4 portamanico	●
23025	1 Cestello portasecchi MX 100 senza portamanico e gancio	●
23008	1 Portapressa IDEA in plastica con aggancio	●
4100PB	1 Strizzatore in plastica	●
KITMX/B	1 Kit montaggio MX 100	●

Codice	Descrizione	Colore
MX 200	Carrello multiuso in plastica carenato	
21001IDEA/BASE	1 Base IDEA completa di 4 ruote in gomma naturale Ø 100 mm s/freno (art. 21008)	●
21003 B	1 Finalino per base	●
23002	2 Spalle MX	○
2250 B	1 Secchio 6 lt	●
2250 R	1 Secchio 6 lt	●
23005 B	1 Reggisacco MX/DMX completo di 4 portamanico, coperchio con leggio e cursore scorrevole	●
23004 B	1 Terminale MX/DMX completo di 3 portamanico	●
23003/1	1 Vaschetta portasecchi superiore MX/DMX	●
23015 GR	1 Vassoio MX	○
KITMX/C	1 Kit montaggio MX 200	●

83x56x105h cm	1 Pz/cartone	21 Kg	0,250 m ³
	1 Pz/cartone	18,5 Kg	0,250 m ³

83x56x105h cm	1 Pz/cartone	19 Kg	0,240 m ³
---------------	--------------	-------	----------------------



Codice	Descrizione	Colore
--------	-------------	--------

MX 201 Carrello multiuso in plastica carenato

21001IDEA/BASE	1 Base IDEA completa di 4 ruote in gomma naturale Ø 100 mm s/freno (art. 21008)	●
21003 B	1 Finalino per base	●
23002	2 Spalle MX	○
23007 B	2 Antine MX complete di serratura (senza chiave)	●
2250 B	1 Secchio 6 lt	●
2250 R	1 Secchio 6 lt	●
23005 B	1 Reggisacco MX/DMX completo di 4 portamanico, coperchio con leggio e cursore scorrevole	●
23004 B	1 Terminale MX/DMX completo di 3 portamanico	●
23003/1	1 Vaschetta portasecchi superiore MX/DMX	●
23015 GR	1 Vassoio MX	○
KITMX/D	1 Kit montaggio MX 201	○

Codice	Descrizione	Colore
--------	-------------	--------

MX 202 Carrello multiuso in plastica carenato

21001IDEA/MX	1 Base IDEA completa di 4 ruote in gomma naturale Ø 100 mm s/freno (art. 21008) e fermo sportelli	●
21003 B	1 Finalino per base	●
23002	2 Spalle MX	○
23011N	1 Sportello sx MX/DMX	○
23012N	1 Sportello dx MX/DMX	○
2250 B	1 Secchio 6 lt	●
2250 R	1 Secchio 6 lt	●
23005 B	1 Reggisacco MX/DMX completo di 4 portamanico, coperchio con leggio e cursore scorrevole	●
23004 B	1 Terminale MX/DMX completo di 3 portamanico	●
23003/1	1 Vaschetta portasecchi superiore MX/DMX	●
23015 GR	1 Vassoio MX	○
KITMX/F	1 Kit montaggio MX 202	○

 83x56x105h cm |  1 Pz/cartone 24 Kg 0,240 m³

 83x56x105h cm |  1 Pz/cartone 24 Kg 0,275 m³



Codice	Descrizione	Colore
MX 203	Carrello multiuso in plastica carenato	
21001IDEA/MX	1 Base IDEA completa di 4 ruote in gomma naturale Ø 100 mm s/freno (art. 21008) e fermo sportelli	●
21003 B	1 Finalino per base	●
23002	2 Spalle MX	○
23007 B	2 Antine MX complete di serratura (senza chiave)	●
23011N	1 Sportello sx MX/DMX	○
23012N	1 Sportello dx MX/DMX	○
2250 B	1 Secchio 6 lt	●
2250 R	1 Secchio 6 lt	●
23005 B	1 Reggisacco MX/DMX completo di 4 portamanico, coperchio con leggio e cursore scorrevole	●
23004 B	1 Terminale MX/DMX completo di 3 portamanico	●
23003/1	1 Vaschetta portasecchi superiore MX/DMX	●
23015 GR	1 Vassoio MX	○
KITMX/G	1 Kit montaggio MX 203-204	

Codice	Descrizione	Colore
MX 204	Carrello multiuso in plastica carenato	
21001IDEA/MX	1 Base IDEA completa di 4 ruote in gomma naturale Ø 100 mm s/freno (art. 21008) e fermo sportelli	●
21003 B	1 Finalino per base	●
23002	2 Spalle MX	○
23007 B	2 Antine MX complete di serratura (senza chiave)	●
23011N	1 Sportello sx MX/DMX	○
23012N	1 Sportello dx MX/DMX	○
2250 B	1 Secchio 6 lt	●
2250 R	1 Secchio 6 lt	●
7030 B	1 Secchio rett. 22 lt	●
7038	1 Coperchio per secchio rett. 22 lt	●
23005 B	1 Reggisacco MX/DMX completo di 4 portamanico, coperchio con leggio e cursore scorrevole	●
23004 B	1 Terminale MX/DMX completo di 3 portamanico	●
23003/1	1 Vaschetta portasecchi superiore MX/DMX	●
23015 GR	1 Vassoio MX	○
23046	1 Cestello portasecchio 22 lt in rilsan MX/DMX	
KITMX/G	1 Kit montaggio MX 203-204	

83x56x105h cm | 1 Pz/cartone 26 Kg 0,275 m³

105x56x105h cm | 1 Pz/cartone 29,5 Kg 0,300 m³



Codice	Descrizione	Colore
--------	-------------	--------

MX 300 Carrello multiuso in plastica carenato

MX 300 S/P Carrello multiuso in plastica carenato senza pressa

21001IDEA/BASE	1 Base IDEA completa di 4 ruote in gomma naturale Ø 100 mm s/freno (art. 21008)	●
21002IDEA/BASE	1 Prolunga con ruota in gomma naturale Ø 100 mm s/freno (art. 21008)	●
23002	2 Spalle MX	○
21005 B	1 Secchio 15 lt IDEA	●
21005 R	1 Secchio 15 lt IDEA	●
2250 B	1 Secchio 6 lt	●
2250 R	1 Secchio 6 lt	●
23005 B	1 Reggisacco MX/DMX completo di 4 portamanico, coperchio con leggio e cursore scorrevole	●
23004 B	1 Terminale MX/DMX completo di 3 portamanico	●
23003/1	1 Vaschetta portasecchi superiore MX/DMX	●
23015 GR	1 Vassoio MX	○
23008	1 Portapressa IDEA in plastica con aggancio	●
4100PB	1 Strizzatore in plastica	●
KITMX/I	1 Kit montaggio MX 300	●

Codice	Descrizione	Colore
--------	-------------	--------

MX 301 Carrello multiuso in plastica carenato

MX 301 S/P Carrello multiuso in plastica carenato senza pressa

21001IDEA/BASE	1 Base IDEA completa di 4 ruote in gomma naturale Ø 100 mm s/freno (art. 21008)	●
21002IDEA/BASE	1 Prolunga con ruota in gomma naturale Ø 100 mm s/freno (art. 21008)	●
23002	2 Spalle MX	○
23007 B	2 Antine MX complete di serratura (senza chiave)	●
21005 B	1 Secchio 15 lt IDEA	●
21005 R	1 Secchio 15 lt IDEA	●
2250 B	1 Secchio 6 lt	●
2250 R	1 Secchio 6 lt	●
23005 B	1 Reggisacco MX/DMX completo di 4 portamanico, coperchio con leggio e cursore scorrevole	●
23004 B	1 Terminale MX/DMX completo di 3 portamanico	●
23003/1	1 Vaschetta portasecchi superiore MX/DMX	●
23015 GR	1 Vassoio MX	○
23008	1 Portapressa IDEA in plastica con aggancio	●
4100PB	1 Strizzatore in plastica	●
KITMX/J	1 Kit montaggio MX 301	●

 110x56x105h cm	1 Pz/cartone	24,5 Kg	0,390 m ³
	1 Pz/cartone	22 Kg	0,390 m ³

 105x56x105h cm	1 Pz/cartone	27,5 Kg	0,390 m ³
	1 Pz/cartone	25 Kg	0,390 m ³



Codice	Descrizione	Colore
MX 302	Carrello multiuso in plastica carenato	
MX 302 S/P	Carrello multiuso in plastica carenato senza pressa	
21001IDEA/BASE	1 Base IDEA completa di 4 ruote in gomma naturale Ø 100 mm s/freno (art. 21008)	●
21002IDEA/MX	1 Prolunga con ruota in gomma naturale Ø 100 mm s/freno (art. 21008) e fermo sportelli	●
23002	2 Spalle MX	○
23011N	1 Sportello sx MX/DMX	○
23012N	1 Sportello dx MX/DMX	○
21005 B	1 Secchio 15 lt IDEA	●
21005 R	1 Secchio 15 lt IDEA	●
2250 B	1 Secchio 6 lt	●
2250 R	1 Secchio 6 lt	●
23005 B	1 Reggisacco MX/DMX completo di 4 portamanico, coperchio con leggio e cursore scorrevole	●
23004 B	1 Terminale MX/DMX completo di 3 portamanico	●
23003/1	1 Vaschetta portasecchi superiore MX/DMX	●
23015 GR	1 Vassoio MX	○
23008	1 Portapressa IDEA in plastica con aggancio	●
4100PB	1 Strizzatore in plastica	●
KITMX/K	1 Kit montaggio MX 302	●

Codice	Descrizione	Colore
MX 303	Carrello multiuso in plastica carenato	
MX 303 S/P	Carrello multiuso in plastica carenato senza pressa	
21001IDEA/BASE	1 Base IDEA completa di 4 ruote in gomma naturale Ø 100 mm s/freno (art. 21008)	●
21002IDEA/MX	1 Prolunga con ruota in gomma naturale Ø 100 mm s/freno (art. 21008) e fermo sportelli	●
23002	2 Spalle MX	○
23007 B	2 Antine MX complete di serratura (senza chiave)	●
23011N	1 Sportello sx MX/DMX	○
23012N	1 Sportello dx MX/DMX	○
21005 B	1 Secchio 15 lt IDEA	●
21005 R	1 Secchio 15 lt IDEA	●
2250 B	1 Secchio 6 lt	●
2250 R	1 Secchio 6 lt	●
23005 B	1 Reggisacco MX/DMX completo di 4 portamanico, coperchio con leggio e cursore scorrevole	●
23004 B	1 Terminale MX/DMX completo di 3 portamanico	●
23003/1	1 Vaschetta portasecchi superiore MX/DMX	●
23015 GR	1 Vassoio MX	○
23008	1 Portapressa IDEA in plastica con aggancio	●
4100PB	1 Strizzatore in plastica	●
KITMX/L	1 Kit montaggio MX 303	●

110x56x105h cm	1 Pz/cartone	29,5 Kg	0,390 m³
	1 Pz/cartone	27 Kg	0,390 m³

110x56x105h cm	1 Pz/cartone	31,5 Kg	0,390 m³
	1 Pz/cartone	29 Kg	0,390 m³



Codice	Descrizione	Colore
--------	-------------	--------

MX 304 Carrello multiuso in plastica carenato

21001IDEA/BASE	1 Base IDEA completa di 4 ruote in gomma naturale Ø 100 mm s/freno (art. 21008)	●
21002IDEA/MX	1 Prolunga con ruota in gomma naturale Ø 100 mm s/freno (art. 21008) e fermo sportelli	●
23002	2 Spalle MX	○
23007 B	2 Antine MX complete di serratura (senza chiave)	●
23011N	1 Sportello sx MX/DMX	○
23012N	1 Sportello dx MX/DMX	○
23020 G	1 Secchio 4 lt	●
23020 R	1 Secchio 4 lt	●
2250 B	1 Secchio 6 lt	●
7030 R	1 Secchio rett. 22 lt	●
23005 B	1 Reggisacco MX/DMX completo di 4 portamanico, coperchio con leggio e cursore scorrevole	●
23004 B	1 Terminale MX/DMX completo di 3 portamanico	●
23003/1	1 Vaschetta portasecchi superiore MX/DMX	○
23015 GR	1 Vassoio MX	○
KITMX/M	1 Kit montaggio MX 304-305-501	

Codice	Descrizione	Colore
--------	-------------	--------

MX 305 Carrello multiuso in plastica carenato

MX 305 S/P Carrello multiuso in plastica carenato senza pressa

21001IDEA/BASE	1 Base IDEA completa di 4 ruote in gomma naturale Ø 100 mm s/freno (art. 21008)	●
21002IDEA/MX	1 Prolunga con ruota in gomma naturale Ø 100 mm s/freno (art. 21008) e fermo sportelli	●
23002	2 Spalle MX	○
23007 B	2 Antine MX complete di serratura (senza chiave)	●
23011N	1 Sportello sx MX/DMX	○
23012N	1 Sportello dx MX/DMX	○
2250 B	1 Secchio 6 lt	●
2250 R	1 Secchio 6 lt	●
23005 B	1 Reggisacco MX/DMX completo di 4 portamanico, coperchio con leggio e cursore scorrevole	●
23004 B	1 Terminale MX/DMX completo di 3 portamanico	●
23003/1	1 Vaschetta portasecchi superiore MX/DMX	○
23015 GR	1 Vassoio MX	○
MAC 50G+P	1 Secchio carrellato in plastica mono 20 lt	●
KITMX/M	1 Kit montaggio MX 304-305-501	

110x56x105h cm | 1 Pz/cartone 27,4 Kg 0,390 m³

110x56x105h cm | 1 Pz/cartone 29,7 Kg 0,390 m³
 1 Pz/cartone 27,2 Kg 0,390 m³



Codice	Descrizione	Colore
MX 400	Carrello multiuso in plastica carenato	
21001IDEA/BASE	1 Base IDEA completa di 4 ruote in gomma naturale Ø 100 mm s/freno (art. 21008)	●
21002IDEA/BASE	1 Prolunga con ruota in gomma naturale Ø 100 mm s/freno (art. 21008)	●
23002	2 Spalle MX	○
2250 B	1 Secchio 6 lt	●
2250 R	1 Secchio 6 lt	●
23005 B	2 Reggisacco MX/DMX completi di 4 portamanico, coperchio con leggio e cursore scorrevole	●
23003/1	1 Vaschetta portasecchi superiore MX/DMX	●
23015 GR	1 Vassoio MX	○
KITMX/O	1 Kit montaggio MX 400	

Codice	Descrizione	Colore
MX 401	Carrello multiuso in plastica carenato	
21001IDEA/BASE	1 Base IDEA completa di 4 ruote in gomma naturale Ø 100 mm s/freno (art. 21008)	●
21002IDEA/BASE	1 Prolunga con ruota in gomma naturale Ø 100 mm s/freno (art. 21008)	●
23002	2 Spalle MX	○
23007 B	2 Antine MX complete di serratura (senza chiave)	●
2250 B	1 Secchio 6 lt	●
2250 R	1 Secchio 6 lt	●
23005 B	2 Reggisacco MX/DMX completi di 4 portamanico, coperchio con leggio e cursore scorrevole	●
23003/1	1 Vaschetta portasecchi superiore MX/DMX	●
23015 GR	1 Vassoio MX	○
KITMX/P	1 Kit montaggio MX 401	

 110x56x105h cm |  1 Pz/cartone 21 Kg 0,290 m³

 110x56x105h cm |  1 Pz/cartone 25 Kg 0,290 m³



Codice	Descrizione	Colore
--------	-------------	--------

MX 402		Carrello multiuso in plastica carenato
21001IDEA/MX	1 Base IDEA completa di 4 ruote in gomma naturale Ø 100 mm s/freno (art. 21008) e fermo sportelli	●
21002IDEA/MX	1 Prolunga con ruota in gomma naturale Ø 100 mm s/freno (art. 21008) e fermo sportelli	●
23002	2 Spalle MX	○
23011N	2 Sportelli sx MX/DMX	○
23012N	2 Sportelli dx MX/DMX	○
2250 B	1 Secchio 6 lt	●
2250 R	1 Secchio 6 lt	●
23005 B	2 Reggisacco MX/DMX completo di 4 portamanico, coperchio con leggio e cursore scorrevole	●
23003/1	1 Vaschetta portasecchi superiore MX/DMX	●
23015 GR	1 Vassoio MX	○
KITMX/Q	1 Kit montaggio MX 402	

Codice	Descrizione	Colore
--------	-------------	--------

MX 403		Carrello multiuso in plastica carenato
21001IDEA/MX	1 Base IDEA completa di 4 ruote in gomma naturale Ø 100 mm s/freno (art. 21008) e fermo sportelli	●
21002IDEA/MX	1 Prolunga con ruota in gomma naturale Ø 100 mm s/freno (art. 21008) e fermo sportelli	●
23002	2 Spalle MX	○
23007 B	2 Antine MX complete di serratura (senza chiave)	●
23011N	2 Sportelli sx MX/DMX	○
23012N	2 Sportelli dx MX/DMX	○
2250 B	1 Secchio 6 lt	●
2250 R	1 Secchio 6 lt	●
23005 B	2 Reggisacco MX/DMX completi di 4 portamanico, coperchio con leggio e cursore scorrevole	●
23003/1	1 Vaschetta portasecchi superiore MX/DMX	●
23015 GR	1 Vassoio MX	○
KITMX/R	1 Kit montaggio MX 403	



 **110x56x105h cm** |  **1 Pz/2 cartoni** **31 Kg** **0,415 m³**

 **110x56x105h cm** |  **1 Pz/2 cartoni** **33Kg** **0,415 m³**





Codice	Descrizione	Colore
MX 500	Carrello multiuso in plastica carenato	
21001IDEA/BASE	1 Base IDEA completa di 4 ruote in gomma naturale Ø 100 mm s/freno (art. 21008)	●
21002IDEA/MX	1 Prolunga con ruota in gomma naturale Ø 100 mm s/freno (art. 21008) e fermo sportelli	●
23002	2 Spalle MX	○
23007 B	2 Antine MX complete di serratura (senza chiave)	●
23011N	1 Sportello sx MX/DMX	○
23012N	1 Sportello dx MX/DMX	○
23020 G	1 Secchio 4 lt	●
23020 R	1 Secchio 4 lt	●
2250 B	1 Secchio 6 lt	●
7030 B	1 Secchio rett. 22 lt	●
7030 R	1 Secchio rett. 22 lt	●
23005 B	1 Reggisacco MX/DMX completo di 4 portamanico, coperchio con leggio e cursore scorrevole	●
23004 B	1 Terminale MX/DMX completo di 3 portamanico	●
23003/1	1 Vaschetta portasecchi superiore MX/DMX	●
23015 GR	1 Vassoio MX	○
GR23085	1 Portasecchio 22 lt in rilsan MX/DMX	
KITMX/S	1 Kit montaggio MX 500	

Codice	Descrizione	Colore
MX 500 AB	Carrello multiuso in plastica carenato antibatterico	
21001AB/BASE	1 Base IDEA/AB completa di 4 ruote in gomma naturale Ø 100 mm s/freno (art. 21008)	●
21002IDEA/MX	1 Prolunga con ruota in gomma naturale Ø 100 mm s/freno (art. 21008) e fermo sportelli	●
23002	2 Spalle MX	○
23007 B	2 Antine MX complete di serratura (senza chiave)	●
23011N	1 Sportello sx MX/DMX	○
23012N	1 Sportello dx MX/DMX	○
23020 G	1 Secchio 4 lt	●
23020 R	1 Secchio 4 lt	●
2250 BA	1 Secchio 6 lt	●
7030 BA	1 Secchio rett. 22 lt	●
7030 RA	1 Secchio rett. 22 lt	●
23005 BA	1 Reggisacco MX/DMX completo di 4 portamanico, coperchio con leggio e cursore scorrevole	●
23004 B	1 Terminale MX/DMX completo di 3 portamanico	●
23003/1	1 Vaschetta portasecchi superiore MX/DMX	●
23015 GR	1 Vassoio MX	○
GR23085	1 Portasecchio 22 lt in rilsan MX/DMX	
KITMX/S	1 Kit montaggio MX 500	

 **110x56x105h cm** |  **1 Pz/cartone** **31 Kg** **0,390 m³**

Optional (raffigurati in foto)

7032 Griglia inox pieghevole (per secchio rett. 22 lt)

 **110x56x105h cm** |  **1 Pz/cartone** **31 Kg** **0,390 m³**



Optional (raffigurati in foto)



7032 Griglia inox pieghevole (per secchio rett. 22 lt)



Codice	Descrizione	Colore
MX 501	Carrello multiuso in plastica carenato	
21001IDEA/BASE	1 Base IDEA completa di 4 ruote in gomma naturale Ø 100 mm s/freno (art. 21008)	●
21002IDEA/MX	1 Prolunga con ruota in gomma naturale Ø 100 mm s/freno (art. 21008) e fermo sportelli	●
23002	2 Spalle MX	○
23007 B	2 Antine MX complete di serratura (senza chiave)	●
23011N	1 Sportello sx MX/DMX	○
23012N	1 Sportello dx MX/DMX	○
23020 G	1 Secchio 4 lt	●
23020 R	1 Secchio 4 lt	●
2250 B	1 Secchio 6 lt	●
7030 B	1 Secchio rett. 22 lt	●
7030 R	1 Secchio rett. 22 lt	●
7038	2 Coperchi per secchio rett. 22 lt	●
23005 B	1 Reggisacco MX/DMX completo di 4 portamanico, coperchio con leggio e cursore scorrevole	●
23004 B	1 Terminale MX/DMX completo di 3 portamanico	●
23003/1	1 Vaschetta portasecchi superiore MX/DMX	●
23015 GR	1 Vassoio MX	○
GR23078	1 Telaio rilsan carrello porta secchi	
KITMX/M	1 Kit montaggio MX 304-305-501	

Codice	Descrizione	Colore
23078	Carrello porta secchi 22 lt MX in rilsan	
GR23078	1 Telaio rilsan carrello porta secchi	●
7030 B	1 Secchio rett. 22 lt	●
7030 R	1 Secchio rett. 22 lt	●









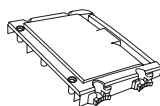

 **110x56x105h cm** |  **1 Pz/2 cartoni** **38 Kg** **0,660 m³**



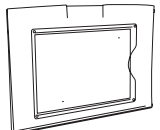
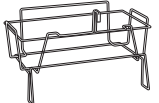
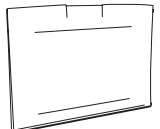
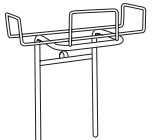
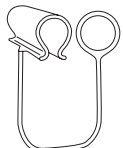

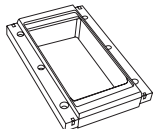
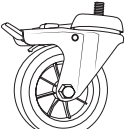
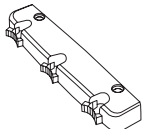
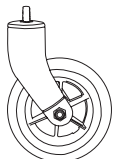

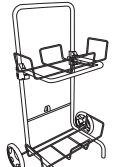



 **60x38x96h cm** |  **2 Pz/cartone** **19 Kg** **0,330 m³**

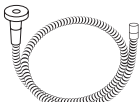

Optional (raffigurati in foto)

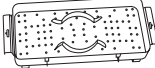
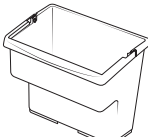
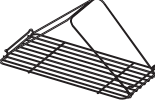
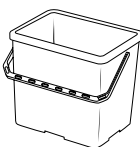
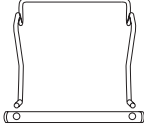
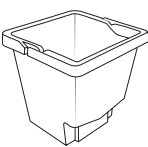
7032 Griglia inox pieghevole (per secchio rett. 22 lt)

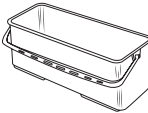
Codice	Descrizione	Colore	Codice	Descrizione	Colore		
	21001 IDEA/BASE	Base IDEA completa di 4 ruote in gomma naturale Ø 100 mm s/freno (art. 21008)	●		21003 B	Finalino per base	●
	21001 IDEA/MX	Base IDEA completa di 4 ruote in gomma naturale Ø 100 mm s/freno (art. 21008) e fermo sportelli	●		23002	Spalla MX	○
	21001 IDEA/PL	Base IDEA completa di 4 ruote Ø 100 mm (art. 24060)	●		23002/100	Spalla MX 100	○
	21001 B	Base IDEA senza ruote	●		23007 B	Antina MX completa di serratura (senza chiave)	●
	21001 AB/BASE	Base IDEA/AB completa di 4 ruote in gomma naturale Ø 100 mm s/freno (art. 21008)	●		23013	Serratura per MX-DMX	
	21001 VS	Base IDEA/AB senza ruote	●		23014	Chiave per serrature MX e DMX	
	21002 IDEA/BASE	Prolunga con ruota in gomma naturale Ø 100 mm s/freno (art. 21008)	●		23011N	Sportello sx MX/DMX	○
	21002 IDEA/MX	Prolunga con ruota in gomma naturale Ø 100 mm s/freno (art. 21008) e fermo sportelli	●		23012N	Sportello dx MX/DMX	○
	21002 B	Prolunga senza ruota per base	●		23010 N	Coppia sportelli MX/DMX	○

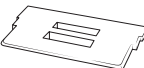
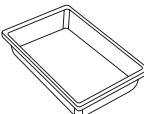
Codice	Descrizione	Colore	Codice	Descrizione	Colore
 23005 B	Reggisacco MX/DMX completo di 4 portamanico, coperchio con leggio e cursore scorrevole	●	 23024	Cestello portasecchi in plastica con portamanico e gancio MX/DMX	●
 23005/100B	Reggisacco MX/DMX senza coperchio completo di 4 portamanico	●	 23025	Cestello portasecchi MX 100 senza portamanico e gancio	●
 23006 B	Coperchio con leggio per reggisacco plastica	●	 23046	Cestello portasecchio 22 lt in rilsan MX/DMX	
 23006/N	Coperchio senza leggio per reggisacco plastica	●	 GR23085	Portasecchio 22 lt in rilsan MX/DMX	
 1701	Clip fermasacco con anello	●	 21008	Ruota in gomma naturale Ø 100 mm s/freno con filetto 10x15	
 23003/1	Vaschetta portasecchi superiore MX/DMX	●	 21009	Ruota in gomma naturale Ø 100 mm c/freno con filetto 10x15	
 23004 B	Terminale MX/DMX completo di 3 portamanico	●	 21027	Ruota morbida per esterno Ø 125 mm	
 2709	Separatore con clip per reggisacco plastica	●	 21028	Ruota morbida per esterno Ø 125 mm spec s/freno (Abbinabile solo con cod. 21029)	
 GR23078	Telaio rilsan carrello porta secchi		 21029	Ruota morbida per esterno Ø 125 mm spec c/freno (Abbinabile solo con cod. 21028)	

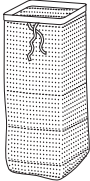
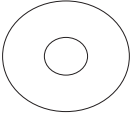
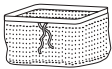
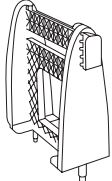
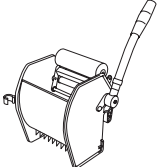
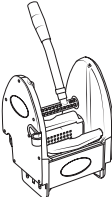
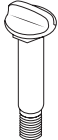
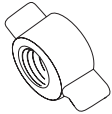
Codice	Descrizione	Colore	Codice	Descrizione	Colore
	24060	Ruota Ø 100 mm con filetto 10x15		2252	Coperchio per secchio 6 lt ●
	24061	Ruota Ø 100 mm XL s/freno con filetto 10x15		7038	Coperchio per secchio rett. 22 lt ●
	24062	Ruota Ø 100 mm XL c/freno con filetto 10x15		1071	Convogliatore acqua FAST
	21012	Ruota Ø 125 mm s/freno con filetto 10x15		7080	Dosatore Tecno-Shower ●
	23020 G 23020 R	Secchio 4 lt ● ●		7032	Griglia inox pieghevole (per secchio rett. 22 lt)
	2250 B 2250 BA 2250 R	Secchio 6 lt ● ● ●		23100	Portarotolo per reggisacco plastica
	21005 B 21005 R	Secchio 15 lt IDEA ● ●		KIT23030	Kit portamanico in gomma
	7030 B 7030 BA 7030 R 7030 RA	Secchio rett. 22 lt ● ● ● ●		4260/1	Pannello segnalatore (PAVIMENTO SCIIVOLOSO / PAVIMENTO BAGNATO)
	23021	Coperchio per secchio 4 lt ●		23015 GR	Vassoio MX ●

Codice	Descrizione	Colore	Codice	Descrizione	Colore
	23095 Sacco in rete 70 lt con laccio di chiusura			4219 Rondella piana 6x24	
	23097 Sacco in rete per secchio 22 lt con laccio di chiusura				
	23008 Portapressa IDEA in plastica con aggancio	●			
	3501 VDM Strizzatore a rullo ELPAROLL				
	4100PB Strizzatore in plastica	●			
	21035 B Perno filettato	●			
	21036 Ghiera filettata con alette	●			
	21030 B Tappo per base	●			
	1648 Vite con aletta plastica 6x15				

Multiuso Plastica Aperti

Ideabase	94
Ideabase PL	103
Ideaplus	106

Multiuso Plastica Aperti



Compatto. Di dimensioni ridotte IDEAPLUS è completo di reggisacco estraibile, supportato da tre piastre di fissaggio.



Modulare. Utilizzando lo strizzatore a rullo ELPAROLL (art. 3501 VDM) è possibile lavorare aggiungendo un secchio supplementare da 12 lt, separando l'acqua sporca da quella pulita.



Dotazioni aggiuntive. Possibilità di applicare reggisacco duo capienza 120 lt per sacco.



Ergonomico. La base ad arco permette al carrello di rimanere sempre stabile sia nel tempo sia con sovraccarichi, garantendo maggiore manovrabilità e minor fatica.





Tutto a portata di mano. Funzione portamanico, portascopa o porta pannello segnalatore.







Codice	Descrizione	Colore
IDEABASE 1	Carrello multiuso in plastica aperto	
21001IDEA/BASE	1 Base IDEA completa di 4 ruote in gomma naturale Ø 100 mm s/freno (art. 21008)	●
21003 B	1 Finalino per base	●
GR21016	1 Spalla diritta in rilsan IDEABASE con reggisacchetto e anello in gomma	●
2250 B	1 Secchio 6 lt	●
2250 R	1 Secchio 6 lt	●
1666/R	1 Cestello portaoggetti in rilsan EUROPE/IDEABASE	●
1535/R	1 Cestello portasecchi in rilsan EUROPE/IDEABASE	●
8311/R	1 Portamanico piccolo	●
KITIDEABASE/A	1 Kit montaggio con 1 portamanico in gomma (art. 2255)	●

Codice	Descrizione	Colore
IDEABASE 2	Carrello IDEABASE a 2 sacchi	
21001IDEA/BASE	1 Base IDEA completa di 4 ruote in gomma naturale Ø 100 mm s/freno (art. 21008)	●
21003 B	1 Finalino per base	●
GR21016	1 Spalla diritta in rilsan IDEABASE con reggisacchetto e anello in gomma	●
GR5013/R	1 Reggisacchetto 120 lt BIO-R con clip fermasacchetto	●
KITIDEABASE/A	1 Kit montaggio con 1 portamanico in gomma (art. 2255)	●

 83x52x105h cm |  1 Pz/cartone 14,3 Kg 0,225 m³

 83x52x105h cm |  1 Pz/cartone 12,7 Kg 0,225 m³

Optional (raffigurati in foto)

7031 Coperchio rettangolare ●

Optional (raffigurati in foto)

7031 Coperchio rettangolare ●



Codice	Descrizione	Colore
--------	-------------	--------

IDEABASE 3 Carrello IDEABASE a 3 sacchi

21001IDEA/BASE	1 Base IDEA completa di 4 ruote in gomma naturale Ø 100 mm s/freno (art. 21008)	●
21003 B	1 Finalino per base	●
GR21015	1 Spalla diritta in rilsan IDEABASE	
GR5013/R	1 Reggisacco 120 lt BIO-R con clip fermasacco	
GR5027/R	1 Reggisacco DUOX70 lt BIO-R rilsan con clip fermasacco	
KITIDEABASE/A	1 Kit montaggio con 1 portamanico in gomma (art. 2255)	

Codice	Descrizione	Colore
--------	-------------	--------

IDEABASE 4 Carrello multiuso in plastica aperto

21001IDEA/BASE	1 Base IDEA completa di 4 ruote in gomma naturale Ø 100 mm s/freno (art. 21008)	●
21003 B	1 Finalino per base	●
GR21016	1 Spalla diritta in rilsan IDEABASE con reggisacco e anello in gomma	
2250 B	1 Secchio 6 lt	●
2250 R	1 Secchio 6 lt	●
7030 R	1 Secchio rett. 22 lt	●
1666/R	1 Cestello portaoggetti in rilsan EUROPE/IDEABASE	●
1535/R	1 Cestello portasecchi in rilsan EUROPE/IDEABASE	
8311/R	1 Portamanico piccolo	●
KITIDEABASE/A	1 Kit montaggio con 1 portamanico in gomma (art. 2255)	

83x52x105h cm | 1 Pz/cartone 12,6 Kg 0,225 m³

83x52x105h cm | 1 Pz/cartone 15,4 Kg 0,225 m³

Optional (raffigurati in foto)

7031	Coperchio rettangolare	●
------	------------------------	---



Codice	Descrizione	Colore
--------	-------------	--------

IDEABASE 5 Carrello multiuso in plastica aperto

IDEABASE 5 S/P Carrello multiuso in plastica aperto senza pressa

21001IDEA/BASE	1 Base IDEA completa di 4 ruote in gomma naturale Ø 100 mm s/freno (art. 21008)	●
21003 B	1 Finalino per base	●
GR21024	1 Spalla curva in rilsan IDEABASE con reggisacco con anello in gomma	●
2250 B	1 Secchio 6 lt	●
2250 R	1 Secchio 6 lt	●
1005 R	1 Secchio 25 lt	●
1666/R	1 Cestello portaoggetti in rilsan EUROPE/IDEABASE	●
1535/R	1 Cestello portasecchi in rilsan EUROPE/IDEABASE	●
GR21020	1 Portapressa in rilsan IDEABASE	●
4100PR	1 Strizzatore in plastica	●
KITIDEABASE/B	1 Kit montaggio con 2 portamanico in gomma (art. 2255)	●

Codice	Descrizione	Colore
--------	-------------	--------

IDEABASE 6 Carrello multiuso in plastica aperto

IDEABASE 6 S/P Carrello multiuso in plastica aperto senza pressa

21001IDEA/BASE	1 Base IDEA completa di 4 ruote in gomma naturale Ø 100 mm s/freno (art. 21008)	●
21003 B	1 Finalino per base	●
GR21024	1 Spalla curva in rilsan IDEABASE con reggisacco con anello in gomma	●
2250 B	1 Secchio 6 lt	●
2250 R	1 Secchio 6 lt	●
21005 B	1 Secchio 15 lt IDEA	●
21005 R	1 Secchio 15 lt IDEA	●
1666/R	1 Cestello portaoggetti in rilsan EUROPE/IDEABASE	●
1535/R	1 Cestello portasecchi in rilsan EUROPE/IDEABASE	●
GR21020	1 Portapressa in rilsan IDEABASE	●
4100PR	1 Strizzatore in plastica	●
KITIDEABASE/B	1 Kit montaggio con 2 portamanico in gomma (art. 2255)	●

95x52x105h cm	1 Pz/cartone	20,4 Kg	0,250 m ³
	1 Pz/cartone	18 Kg	0,250 m ³

95x52x105h cm	1 Pz/cartone	21 Kg	0,250 m ³
	1 Pz/cartone	19,4 Kg	0,250 m ³



Codice	Descrizione	Colore
--------	-------------	--------

IDEABASE 7 Carrello multiuso in plastica aperto

21001IDEA/BASE	1 Base IDEA completa di 4 ruote in gomma naturale Ø 100 mm s/freno (art. 21008)	●
21003 B	1 Finalino per base	●
GR21016	1 Spalla diritta in rilsan IDEABASE con reggisacco e anello in gomma	●
2250 B	1 Secchio 6 lt	●
2250 R	1 Secchio 6 lt	●
COMFORT R	1 Secchio 15 lt COMFORT con strizzino	●
1666/R	1 Cestello portaoggetti in rilsan EUROPE/IDEABASE	●
1535/R	1 Cestello portasecchi in rilsan EUROPE/IDEABASE	●
8311/R	1 Portamanico piccolo	●
KITIDEABASE/A	1 Kit montaggio con 2 portamanico in gomma (art. 2255)	●

Codice	Descrizione	Colore
--------	-------------	--------

IDEABASE 8 Carrello multiuso in plastica aperto

21001IDEA/BASE	1 Base IDEA completa di 4 ruote in gomma naturale Ø 100 mm s/freno (art. 21008)	●
21003 B	1 Finalino per base	●
GR21015	1 Spalla diritta in rilsan IDEABASE	●
GR21016	1 Spalla diritta in rilsan IDEABASE con reggisacco e anello in gomma	●
2250 B	1 Secchio 6 lt	●
2250 R	1 Secchio 6 lt	●
21010 B	1 Vassoio IDEA	●
21010 R	1 Vassoio IDEA	●
KITIDEABASE/D	1 Kit montaggio con 2 portamanico in gomma (art. 2255)	●

83x52x105h cm | 1 Pz/cartone 15 Kg 0,225 m³

83x52x105h cm | 1 Pz/cartone 15,5 Kg 0,225 m³

Optional (raffigurati in foto)

7031 Coperchio rettangolare ●



Codice	Descrizione	Colore
IDEABASE 9	Carrello multiuso in plastica aperto	
21001IDEA/BASE	1 Base IDEA completa di 4 ruote in gomma naturale Ø 100 mm s/freno (art. 21008)	●
21003 B	1 Finalino per base	●
GR21015	1 Spalla diritta in rilsan IDEABASE	
GR21016	1 Spalla diritta in rilsan IDEABASE con reggisacchetto e anello in gomma	
2250 B	1 Secchio 6 lt	●
2250 R	1 Secchio 6 lt	●
1666/R	2 Cestelli portaoggetti in rilsan EUROPE/IDEABASE	●
21010 B	1 Vassoio IDEA	●
21010 R	1 Vassoio IDEA	●
KITIDEABASE/D	1 Kit montaggio con 2 portamanico in gomma (art. 2255)	

Codice	Descrizione	Colore
IDEABASE 10	Carrello multiuso in plastica aperto	
21001IDEA/BASE	1 Base IDEA completa di 4 ruote in gomma naturale Ø 100 mm s/freno (art. 21008)	●
21002IDEA/BASE	1 Prolunga con ruota in gomma naturale Ø 100 mm s/freno (art. 21008)	●
GR21015	1 Spalla diritta in rilsan IDEABASE	
GR21016	1 Spalla diritta in rilsan IDEABASE con reggisacchetto e anello in gomma	
2250 B	1 Secchio 6 lt	●
2250 R	1 Secchio 6 lt	●
21010 B	1 Vassoio IDEA	●
21010 R	1 Vassoio IDEA	●
KITIDEABASE/D	1 Kit montaggio con 2 portamanico in gomma (art. 2255)	

 83x52x105h cm |  1 Pz/cartone 16,8 Kg 0,225 m³

 110x52x105h cm |  1 Pz/cartone 17 Kg 0,225 m³

Optional (raffigurati in foto)

7031 Coperchio rettangolare ●



Codice	Descrizione	Colore
--------	-------------	--------

IDEABASE 11 Carrello multiuso in plastica aperto

21001IDEA/BASE	1 Base IDEA completa di 4 ruote in gomma naturale Ø 100 mm s/freno (art. 21008)	●
21002IDEA/BASE	1 Prolunga con ruota in gomma naturale Ø 100 mm s/freno (art. 21008)	●
GR21015	1 Spalla destra in rilsan IDEABASE	
GR21016	1 Spalla destra in rilsan IDEABASE con reggisacco e anello in gomma	
2250 B	1 Secchio 6 lt	●
2250 R	1 Secchio 6 lt	●
7030 R	1 Secchio rett. 22 lt	●
21010 B	1 Vassoio IDEA	●
21010 R	1 Vassoio IDEA	●
KITIDEABASE/D	1 Kit montaggio con 2 portamanico in gomma (art. 2255)	

Codice	Descrizione	Colore
--------	-------------	--------

IDEABASE 11 FR Carrello multiuso in plastica aperto

21001IDEA/BASE	1 Base IDEA completa di 4 ruote in gomma naturale Ø 100 mm s/freno (art. 21008)	●
21002IDEA/BASE	1 Prolunga con ruota in gomma naturale Ø 100 mm s/freno (art. 21008)	●
GR21015/PRE	1 Spalla destra IDEABASE con portasecchio in rilsan	
GR21016	1 Spalla destra in rilsan IDEABASE con reggisacco e anello in gomma	
2250 B	1 Secchio 6 lt	●
2250 R	1 Secchio 6 lt	●
7030 B	1 Secchio rett. 22 lt	●
7030 R	1 Secchio rett. 22 lt	●
21010 B	1 Vassoio IDEA	●
21010 R	1 Vassoio IDEA	●
KITIDEABASE/D	1 Kit montaggio con 2 portamanico in gomma (art. 2255)	

110x52x105h cm	1 Pz/cartone	18,4 Kg	0,225 m ³
----------------	--------------	---------	----------------------

110x52x105h cm	1 Pz/cartone	22 Kg	0,225 m ³
----------------	--------------	-------	----------------------

Optional (raffigurati in foto)

7031	Coperchio rettangolare	●
7032	Griglia inox pieghevole (per secchio rett. 22 lt)	



Codice	Descrizione	Colore
--------	-------------	--------

IDEABASE 12 Carrello multiuso in plastica aperto

IDEABASE 12 S/P Carrello multiuso in plastica aperto senza pressa



21001IDEA/BASE	1 Base IDEA completa di 4 ruote in gomma naturale Ø 100 mm s/freno (art. 21008)	●
21002IDEA/BASE	1 Prolunga con ruota in gomma naturale Ø 100 mm s/freno (art. 21008)	●
GR21015	1 Spalla destra in rilsan IDEABASE	
GR21016	1 Spalla destra in rilsan IDEABASE con reggisacco e anello in gomma	
2250 B	1 Secchio 6 lt	●
2250 R	1 Secchio 6 lt	●
MAC 50R+P	1 Secchio carrellato in plastica mono 20 lt	●
21010 B	1 Vassoio IDEA	●
21010 R	1 Vassoio IDEA	●
KITIDEABASE/D	1 Kit montaggio con 2 portamanico in gomma (art. 2255)	●



Codice	Descrizione	Colore
--------	-------------	--------

IDEABASE 13 Carrello multiuso in plastica aperto

IDEABASE 13 S/P Carrello multiuso in plastica aperto senza pressa

21001IDEA/BASE	1 Base IDEA completa di 4 ruote in gomma naturale Ø 100 mm s/freno (art. 21008)	●
21002IDEA/BASE	1 Prolunga con ruota in gomma naturale Ø 100 mm s/freno (art. 21008)	●
GR21015	1 Spalla destra in rilsan IDEABASE	
GR21016	1 Spalla destra in rilsan IDEABASE con reggisacco e anello in gomma	
2250 B	1 Secchio 6 lt	●
2250 R	1 Secchio 6 lt	●
21005 B	1 Secchio 15 lt IDEA	●
21005 R	1 Secchio 15 lt IDEA	●
21010 B	1 Vassoio IDEA	●
21010 R	1 Vassoio IDEA	●
GR21020	1 Portapressa in rilsan IDEABASE	
4100PR	1 Strizzatore in plastica	●
KITIDEABASE/E	1 Kit montaggio con 3 portamanico in gomma (art. 2255)	●

 110x52x105h cm	 1 Pz/cartone	22,4 Kg	0,250 m ³
	 1 Pz/cartone	20 Kg	0,250 m ³

 110x52x105h cm	 1 Pz/cartone	22 Kg	0,250 m ³
	 1 Pz/cartone	19,7 Kg	0,250 m ³

Optional (raffigurati in foto)

7031	Coperchio rettangolare	●
------	------------------------	---



Codice	Descrizione	Colore
--------	-------------	--------

IDEABASE 16 Carrello multiuso in plastica aperto

IDEABASE 16 S/P Carrello multiuso in plastica aperto senza pressa

80025IDEA/BASE	1 Base maxi IDEA completa di 2 ruote c/freno (art. 80061) e 2 s/freno (art. 80060) Ø 125 mm	●
80043IDEA/BASE	1 Prolunga per base maxi con ruota Ø 125 mm (art. 80060)	●
21003 B	1 Finalino per base	●
GR21015	1 Spalla diritta in rilsan IDEABASE	●
GR21016	1 Spalla diritta in rilsan IDEABASE con reggisacco e anello in gomma	●
2250 B	1 Secchio 6 lt	●
2250 G	1 Secchio 6 lt	●
2250 R	1 Secchio 6 lt	●
2250 VS	1 Secchio 6 lt	●
21005 B	1 Secchio 15 lt IDEA	●
21005 R	1 Secchio 15 lt IDEA	●
2253	1 Separatore flaconi per secchio 6 lt	●
21070 B	1 Vassoio maxi IDEA con 4 portamanico integrati	●
21070 R	1 Vassoio maxi IDEA con 4 portamanico integrati	●
24058	1 Portapressa IDEA in plastica	●
4100PR	1 Strizzatore in plastica	●
KITIDEABASE/H	1 Kit montaggio con 2 ganci senza aggancio (art. 2231/G) e 2 portamanico senza aggancio (art. 2230/P)	●

Codice	Descrizione	Colore
--------	-------------	--------

IDEABASE 17 Carrello multiuso in plastica aperto

80025IDEA/BASE	1 Base maxi IDEA completa di 2 ruote c/freno (art. 80061) e 2 s/freno (art. 80060) Ø 125 mm	●
80043IDEA/BASE	1 Prolunga per base maxi con ruota Ø 125 mm (art. 80060)	●
21003 B	1 Finalino per base	●
GR21015/PRE	1 Spalla diritta IDEABASE con portasecchio in rilsan	●
GR21016	1 Spalla diritta in rilsan IDEABASE con reggisacco e anello in gomma	●
2250 B	1 Secchio 6 lt	●
2250 G	1 Secchio 6 lt	●
2250 R	1 Secchio 6 lt	●
2250 VS	1 Secchio 6 lt	●
7030 B	1 Secchio rett. 22 lt	●
7030 R	1 Secchio rett. 22 lt	●
2253	1 Separatore flaconi per secchio 6 lt	●
21070 B	1 Vassoio maxi IDEA con 4 portamanico integrati	●
21070 R	1 Vassoio maxi IDEA con 4 portamanico integrati	●
KITIDEABASE/I	1 Kit montaggio con 2 ganci senza aggancio (art. 2231/G) e 2 portamanico senza aggancio (art. 2230/P)	●

135x61x113h cm	1 Pz/cartone	28,5 Kg	0,390 m ³
	1 Pz/cartone	26 Kg	0,390 m ³

135x61x113h cm	1 Pz/cartone	26 Kg	0,390 m ³
----------------	--------------	-------	----------------------

Optional (raffigurati in foto)

7032	1 Griglia inox pieghevole (per secchio 22 lt)
------	---



Codice	Descrizione	Colore
--------	-------------	--------

IDEABASE 18 Carrello multiuso in plastica aperto

80025IDEA/BASE	1 Base maxi IDEA completa di 2 ruote c/freno (art. 80061) e 2 s/freno (art. 80060) Ø 125 mm	●
21003 B	2 Finalini per base	●
2250 B	1 Secchio 6 lt	●
2250 R	1 Secchio 6 lt	●
24053	1 Cestello portaoggetti IDEA	●
24051	1 Cestello portasecchi IDEA	●
21068	1 Reggisacco DUOx120 lt in rilsan con anelli in gomma senza coperchi (per IDEABASE)	●
GR21015/DUO	1 Spalla destra in rilsan con piastre per reggisacco DUO	●
GR21015	1 Spalla sinistra in rilsan IDEABASE	●
21070 B	1 Vassoio maxi IDEA con 4 portamanico integrati	●
21070 R	1 Vassoio maxi IDEA con 4 portamanico integrati	●
KITIDEABASE/I	1 Kit montaggio con 2 ganci senza aggancio (art. 2231/G) e 2 portamanico senza aggancio (art. 2230/P)	●

Codice	Descrizione	Colore
--------	-------------	--------

IDEABASE 20 Carrello multiuso in plastica aperto

21001IDEA/PL	1 Base IDEA completa di 4 ruote Ø 100 mm (art. 24060)	●
21003 B	1 Finalino per base	●
GR21024	1 Spalla curva in rilsan IDEABASE con reggisacco con anello in gomma	●
23020 G	1 Secchio 4 lt	●
23020 R	1 Secchio 4 lt	●
7030 B	1 Secchio rett. 22 lt	●
7030 R	1 Secchio rett. 22 lt	●
24053	1 Cestello portaoggetti IDEA	●
24051	1 Cestello portasecchi IDEA	●
GR23085	1 Portasecchio 22 lt in rilsan MX/DMX	●
KITIDEABASE/D	1 Kit montaggio con 2 portamanico in gomma (art. 2255)	●

120x60x116h cm	1 Pz/cartone	22,5 Kg	0,250 m ³
----------------	--------------	---------	----------------------

95x52x105h cm	1 Pz/cartone	20 Kg	0,250 m ³
---------------	--------------	-------	----------------------



Codice	Descrizione	Colore
--------	-------------	--------

IDEABASE 1 PL Carrello multiuso in plastica aperto

21001IDEA/PL	1 Base IDEA completa di 4 ruote Ø 100 mm (art. 24060)	●
21003 B	1 Finalino per base	●
GR21016	1 Spalla dritta in rilsan IDEABASE con reggisacchetto e anello in gomma	●
2250 B	1 Secchio 6 lt	●
2250 R	1 Secchio 6 lt	●
24053	1 Cestello portaoggetti IDEA	●
24051	1 Cestello portasecchi IDEA	●
KITIDEABASE/A	1 Kit montaggio con 1 portamanico in gomma (art. 2255)	●

Codice	Descrizione	Colore
--------	-------------	--------

IDEABASE 4 PL Carrello multiuso in plastica aperto

21001IDEA/PL	1 Base IDEA completa di 4 ruote Ø 100 mm (art. 24060)	●
21003 B	1 Finalino per base	●
GR21016	1 Spalla dritta in rilsan IDEABASE con reggisacchetto e anello in gomma	●
2250 B	1 Secchio 6 lt	●
2250 R	1 Secchio 6 lt	●
7030 R	1 Secchio rett. 22 lt	●
24053	1 Cestello portaoggetti IDEA	●
24051	1 Cestello portasecchi IDEA	●
KITIDEABASE/A	1 Kit montaggio con 1 portamanico in gomma (art. 2255)	●

 83x52x105h cm |  1 Pz/cartone 14 Kg 0,225 m³

 83x52x105h cm |  1 Pz/cartone 15 Kg 0,225 m³



Codice	Descrizione	Colore
--------	-------------	--------

IDEABASE 6 PL Carrello multiuso in plastica aperto

IDEABASE 6 PL Carrello multiuso in plastica aperto senza pressa

21001IDEA/PL	1 Base IDEA completa di 4 ruote Ø 100 mm (art. 24060)	●
21003 B	1 Finalino per base	●
GR24055	1 Spalla curva IDEABASE PL con reggisacco e anello in gomma	●
2250 B	1 Secchio 6 lt	●
2250 R	1 Secchio 6 lt	●
21005 B	1 Secchio 15 lt IDEA	●
21005 R	1 Secchio 15 lt IDEA	●
24053	1 Cestello portaoggetti IDEA	●
24051	1 Cestello portasecchi IDEA	●
24058	1 Portapressa IDEA in plastica	●
4100PR	1 Strizzatore in plastica	●
KITIDEABASE/C	1 Kit montaggio con 2 portamanico in gomma (art. 2255)	●

Codice	Descrizione	Colore
--------	-------------	--------

IDEABASE 7 PL Carrello multiuso in plastica aperto

21001IDEA/PL	1 Base IDEA completa di 4 ruote Ø 100 mm (art. 24060)	●
21003 B	1 Finalino per base	●
GR21016	1 Spalla diritta in rilsan IDEABASE con reggisacco e anello in gomma	●
2250 B	1 Secchio 6 lt	●
2250 R	1 Secchio 6 lt	●
24053	1 Cestello portaoggetti IDEA	●
24051	1 Cestello portasecchi IDEA	●
COMFORT R	1 Secchio 15 lt COMFORT con strizzino	●
KITIDEABASE/A	1 Kit montaggio con 1 portamanico in gomma (art. 2255)	●

95x52x105h cm	1 Pz/cartone	17 Kg	0,250 m ³
	1 Pz/cartone	15 Kg	0,250 m ³

83x52x105h cm	1 Pz/cartone	14 Kg	0,225 m ³
---------------	--------------	-------	----------------------



Codice	Descrizione	Colore
--------	-------------	--------

IDEABASE 9 PL Carrello multiuso in plastica aperto

21001IDEA/PL	1 Base IDEA completa di 4 ruote Ø 100 mm (art. 24060)	●
21003 B	1 Finalino per base	●
GR21015	1 Spalla diritta in rilsan IDEABASE	
GR21016	1 Spalla diritta in rilsan IDEABASE con reggisacco e anello in gomma	
2250 B	1 Secchio 6 lt	●
2250 R	1 Secchio 6 lt	●
24053	2 Cestelli portaoggetti IDEA	●
21010 B	1 Vassoio IDEA	●
21010 R	1 Vassoio IDEA	●
KITIDEABASE/D	1 Kit montaggio con 2 portamanico in gomma (art. 2255)	●

Codice	Descrizione	Colore
--------	-------------	--------

IDEABASE 13 PL Carrello multiuso in plastica aperto

IDEABASE 13 PL Carrello multiuso in plastica aperto S/P senza pressa

21001IDEA/PL	1 Base IDEA completa di 4 ruote Ø 100 mm (art. 24060)	●
21002IDEA/PL	1 Prolunga IDEA con ruota Ø 100 mm (art. 24060)	●
GR21015	1 Spalla diritta in rilsan IDEABASE	
GR21016	1 Spalla diritta in rilsan IDEABASE con reggisacco e anello in gomma	
2250 B	1 Secchio 6 lt	●
2250 R	1 Secchio 6 lt	●
21005 B	1 Secchio 15 lt IDEA	●
21005 R	1 Secchio 15 lt IDEA	●
24058	1 Portapressa IDEA in plastica	●
4100PR	1 Strizzatore in plastica	●
21010 B	1 Vassoio IDEA	●
21010 R	1 Vassoio IDEA	●
KITIDEABASE/F	1 Kit montaggio con 3 portamanico in gomma (art. 2255)	●

 83x52x105h cm |  1 Pz/cartone 16,3 Kg 0,225 m³

 110x52x105h cm |  1 Pz/cartone 22 Kg 0,250 m³
 1 Pz/cartone 19,5 Kg 0,250 m³



Codice	Descrizione	Colore
IDEAPLUS 15	Carrello multiuso in plastica aperto	
IDEAPLUS 15 S/P	Carrello multiuso in plastica aperto senza pressa	
GR20070	1 Struttura IDEAPLUS in rilsan con viti	
GR8204/R	1 Reggisacco 70 lt BIO-R in rilsan con clip fermasacco	
8311/R	1 Portamanico piccolo	●
20060	1 Vaschetta portaoggetti laterale	●
2250 B	1 Secchio 6 lt	●
2250 R	1 Secchio 6 lt	●
1205 R	1 Secchio 15 lt	●
4100PR	1 Strizzatore in plastica	●
2024 R	1 Vassoio mini	●

Codice	Descrizione	Colore
IDEAPLUS 25	Carrello multiuso in plastica aperto	
IDEAPLUS 25 S/P	Carrello multiuso in plastica aperto senza pressa	
GR20070	1 Struttura IDEAPLUS in rilsan con viti	
GR8204/R	1 Reggisacco 70 lt BIO-R in rilsan con clip fermasacco	
8311/R	1 Portamanico piccolo	●
20060	1 Vaschetta portaoggetti laterale	●
2250 B	1 Secchio 6 lt	●
2250 R	1 Secchio 6 lt	●
1005 R	1 Secchio 25 lt	●
4100PR	1 Strizzatore in plastica	●
2024 R	1 Vassoio mini	●

70x54x125h cm	1 Pz/cartone	15,4 Kg	0,240 m ³
	1 Pz/cartone	13,4 Kg	0,240 m ³

70x54x125h cm	1 Pz/cartone	15,4 Kg	0,240 m ³
	1 Pz/cartone	13,4 Kg	0,240 m ³



Codice	Descrizione	Colore
--------	-------------	--------

IDEAPLUS 2x15 Carrello multiuso in plastica aperto

IDEAPLUS 2x15 Carrello multiuso in plastica aperto S/P senza pressa

GR20070	1 Struttura IDEAPLUS in rilsan con viti	
GR8204/R	1 Reggisacco 70 lt BIO-R in rilsan con clip fermasacco	
8311/R	1 Portamanico piccolo	●
20060	1 Vaschetta portaoggetti laterale	●
2250 B	1 Secchio 6 lt	●
2250 R	1 Secchio 6 lt	●
1205 B	1 Secchio 15 lt	●
1205 R	1 Secchio 15 lt	●
4100PR	1 Strizzatore in plastica	●
2024 R	1 Vassoio mini	●

Codice	Descrizione	Colore
--------	-------------	--------



IDEAPLUS 2x10+E Carrello multiuso in plastica aperto







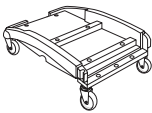
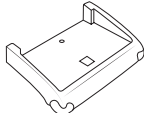
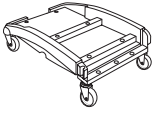
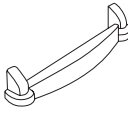
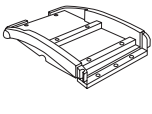
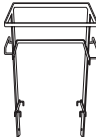
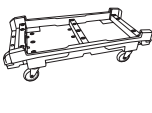
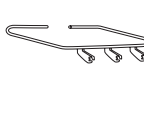
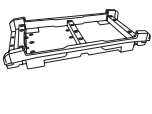
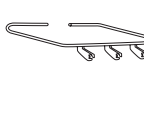
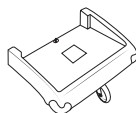

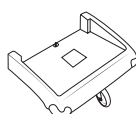
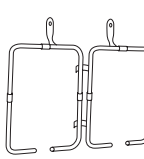
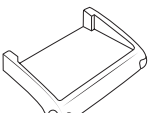
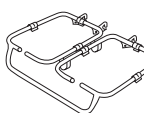
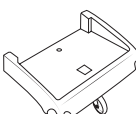

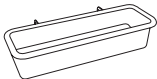

IDEAPLUS 2x10 Carrello multiuso in plastica aperto S/P senza pressa

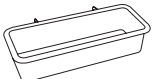
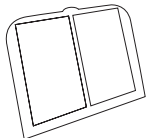
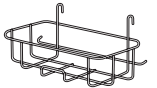

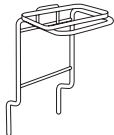

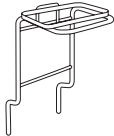

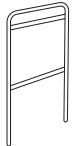
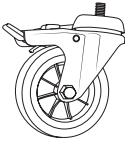





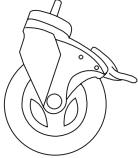

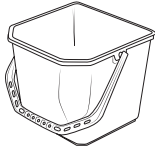

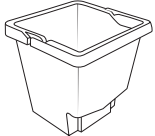
GR20070	1 Struttura IDEAPLUS in rilsan con viti	
GR8204/R	1 Reggisacco 70 lt BIO-R in rilsan con clip fermasacco	
8311/R	1 Portamanico piccolo	●
20060	1 Vaschetta portaoggetti laterale	●
2250 B	1 Secchio 6 lt	●
2250 R	1 Secchio 6 lt	●
4635	1 Secchio 8 lt	●
1005 R	1 Secchio 25 lt	●
3501 VDM	1 Strizzatore a rullo ELPAROLL	●
2024 R	1 Vassoio mini	●

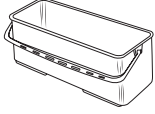

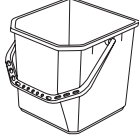

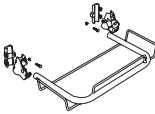

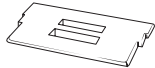
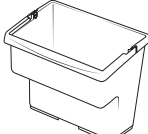

70x54x125h cm	<table border="0"> <tr> <td></td> <td>1 Pz/cartone</td> <td>16,5 Kg</td> <td>0,240 m³</td> </tr> <tr> <td></td> <td>1 Pz/cartone</td> <td>14 Kg</td> <td>0,240 m³</td> </tr> </table>		1 Pz/cartone	16,5 Kg	0,240 m ³		1 Pz/cartone	14 Kg	0,240 m ³
	1 Pz/cartone	16,5 Kg	0,240 m ³						
	1 Pz/cartone	14 Kg	0,240 m ³						

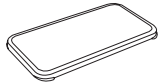

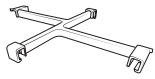
70x54x125h cm	<table border="0"> <tr> <td></td> <td>1 Pz/cartone</td> <td>16,5 Kg</td> <td>0,240 m³</td> </tr> <tr> <td></td> <td>1 Pz/cartone</td> <td>14 Kg</td> <td>0,240 m³</td> </tr> </table>		1 Pz/cartone	16,5 Kg	0,240 m ³		1 Pz/cartone	14 Kg	0,240 m ³
	1 Pz/cartone	16,5 Kg	0,240 m ³						
	1 Pz/cartone	14 Kg	0,240 m ³						

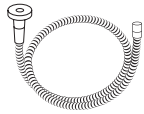
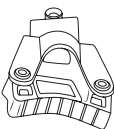
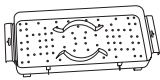
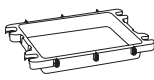
	Codice	Descrizione	Colore		Codice	Descrizione	Colore
	21001 IDEA/BASE	Base IDEA completa di 4 ruote in gomma naturale Ø 100 mm s/freno (art. 21008)	●		80043 B	Prolunga senza ruota per base maxi	●
	21001 IDEA/PL	Base IDEA completa di 4 ruote Ø 100 mm (art. 24060)	●		21003 B	Finalino per base	●
	21001 B	Base IDEA senza ruote	●		GR20070	Struttura IDEAPLUS in rilsan con viti	
	80025 IDEA/BASE	Base maxi IDEA completa di 2 ruote c/freno (art. 80061) e 2 s/freno (art. 80060) Ø 125 mm	●		GR5013/R	Reggisacco 120 lt Bio -R in rilsan completo di clip fermasacco e attacco coperchio (art. 7031)	
	80025 B	Base maxi IDEA senza ruote	●		GR8204/R	Reggisacco 70 lt BIO -R in rilsan con clip fermasacco	
	21002 IDEA/BASE	Prolunga con ruota in gomma naturale Ø 100 mm s/freno (art. 21008)	●		21068	Reggisacco DUO 120 lt in rilsan con anelli in gomma s/coperchi (per IDEABASE)	
	21002 IDEA/PL	Prolunga IDEA con ruota Ø 100 mm (art. 24060)	●		GR5027/R	Reggisacco DUO 70 lt BIO-R in rilsan con clip fermasacco	
	21002 B	Prolunga senza ruota per base	●		21018	Reggisacco DUO 70 lt IDEABASE con maniglia	
	80043 IDEA/BASE	Prolunga per base maxi con ruota Ø 125 mm (art. 80060)	●		1386	Anello in gomma piccolo	

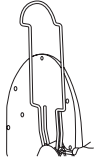
Codice	Descrizione	Colore	Codice	Descrizione	Colore
	1622 Anello in gomma grande			24053 Cestello portaoggetti IDEA	●
	7031 BSV Coperchio rettangolare	●		1666/R Cestello portaoggetti in rilsan EUROPE/IDEABASE	
	7031 Coperchio rettangolare	●		24051 Cestello portasecchi IDEA	●
	7031AZR 7031RZR Coperchio rettangolare con leggio	● ●		1535/R Cestello portasecchi in rilsan EUROPE/IDEABASE	
	2710 Corsore compl. per reggisacco rett. (con 2 clip art. 1701)	● ●		20060 Vaschetta portaoggetti laterale	●
	GR21024 Spalla curva in rilsan IDEABASE con reggisacco e anello in gomma			1038 Ruota Ø 80 mm con filetto 10x15	
	GR24055 Spalla curva IDEABASE PL con reggisacco e anello in gomma			21008 Ruota in gomma naturale Ø 100 mm s/freno con filetto 10x15	
	GR21015 Spalla diritta in rilsan IDEABASE			21009 Ruota in gomma naturale Ø 100 mm c/freno con filetto 10x15	
	GR21016 Spalla diritta in rilsan IDEABASE con reggisacco e anello in gomma			21027 Ruota morbida per esterno Ø 125 mm	

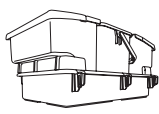
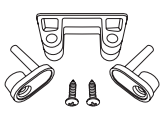
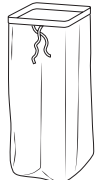
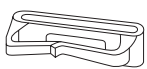
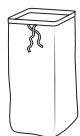
	Codice	Descrizione	Colore		Codice	Descrizione	Colore
	21028	Ruota morbida per esterno Ø 125 mm spec s/freno (Abbinabile solo con cod. 21029)			2250 B 2250 G 2250 R 2250 VS	Secchio 6 lt	● ● ● ●
	21029	Ruota morbida per esterno Ø 125 mm spec c/freno (Abbinabile solo con cod. 21028)			4635	Secchio 8 lt	●
	24060	Ruota Ø 100 mm con filetto 10x15			1205 B 1205 R	Secchio 15 lt	● ●
	24061	Ruota Ø 100 mm XL s/freno con filetto 10x15			21005 B 21005 R	Secchio 15 lt IDEA	● ●
	24062	Ruota Ø 100 mm XL c/freno con filetto 10x15			7030 B 7030 R	Secchio rett. 22 lt	● ●
	21012	Ruota Ø 125 mm s/freno con filetto 10x15			1005 R	Secchio 25 lt	●
	80060	Ruota Ø 125 mm s/freno attacco piastra per base maxi			21065 KIT80040	Portasecchio 22 lt in rilsan per IDEABASE Kit di fissaggio per spalla rilsan (1x80040, 2x2701/R, 2x2726, 2x2730)	
	80061	Ruota Ø 125 mm c/freno attacco piastra per base maxi			23021	Coperchio per secchio 4 lt	●
	23020 B 23020 G 23020 R 23020 VS	Secchio 4 lt	● ● ● ●		2252	Coperchio per secchio 6 lt	●

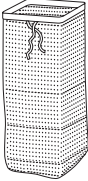
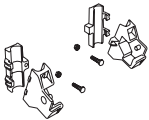
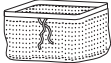
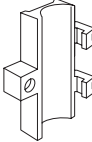
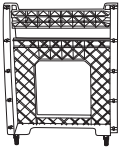
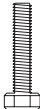
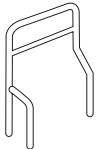
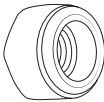
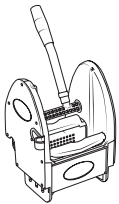
Codice	Descrizione	Colore	Codice	Descrizione	Colore
	7038 Coperchio per secchio rett. 22 lt	●		2230/P Portamanico senza aggancio	●
	2253 Separatore flaconi per secchio 6 lt	●		2231/G Gancio senza aggancio	●
	1071 Convogliatore acqua FAST			2255 Portamanico in gomma con aggancio Ø 22 mm	
	7080 Dosatore Tecno-Shower	●		21010 B 21010 R Vassoio IDEA	● ●
	7032 Griglia inox pieghevole (per secchio rett. 22 lt)			21070 B 21070 R Vassoio maxi IDEA con 4 portamanico integrati	● ●
	24070 Kit porta pannello segnalatore			2024 R Vassoio mini	●
	4260/1 Pannello segnalatore (PAVIMENTO SCIVOLOSO/PAVIMENTO BAGNATO)			21011 B Riduttore per vassoio IDEA	●
	KIT23030 Kit portamanico in gomma			1677 B 1677 R Sacco nylon 120 lt (72x100 cm)	● ●
	8311/R Portamanico piccolo	●		1678 B 1678 R Sacco nylon 70 lt (52x100 cm)	● ●

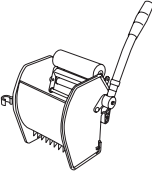
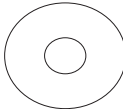
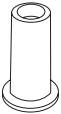
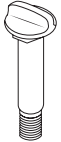
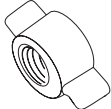
Codice	Descrizione	Colore	Codice	Descrizione	Colore
	23095 Sacco in rete 70 lt con laccio di chiusura			KIT80040 Kit di fissaggio per spalla rilsan (1x80040, 2x2701/R, 2x2726, 2x2730)	
	23097 Sacco in rete per secchio 22 lt con laccio di chiusura			2701/R Contropiastra alluminio per rilsan	
	24058 Portapressa IDEA in plastica	●		2726 Vite inox TE 6x25	
	GR21020 Portapressa in rilsan IDEABASE			2730 Dado autobloccante inox 6MA	
	4100PR Strizzatore in plastica	●		1648 Vite con aletta plastica 6x15	
	3501 VDM Strizzatore a rullo ELPAROLL			4219 Rondella piana 6x24	
	21030 B Tappo per base	●			
	21035 B Perno filettato	●			
	21036 Ghiera filettata con alette	●			





Multiuso Cromati

MINIMAX	118
L	120
HO	124
JOKER	128
H	134
EF	138

Multiuso Cromati





Pieghevole e compatto. Carrelli pieghevoli, ergonomici e straordinariamente compatti.



Codice	Descrizione	Colore
MINIMAX 2	Carrello cromato pieghevole	
MINIMAX 2 S/P	Carrello cromato pieghevole senza pressa	
GRMINIMAX2	1 Telaio pieghevole MINIMAX 2 con reggisacco con anello in gomma, 2 ruote Ø 80 mm (art. 1430) con paracolpi e 2 ruote Ø 200 mm (art. 1696)	
1005 R	1 Secchio 25 lt	●
4100PR	1 Strizzatore in plastica	●
2023 A	1 Vassoio MINIMAX	●



Codice	Descrizione	Colore
MINIMAX 3	Carrello cromato pieghevole	
MINIMAX 3 S/P	Carrello cromato pieghevole senza pressa	
GRMINIMAX3	1 Telaio pieghevole MINIMAX 3 con reggisacco con anello in gomma, 4 ruote Ø 80 mm (art. 1430) e paracolpi	
2250 A	1 Secchio 6 lt	●
2250 R	1 Secchio 6 lt	●
1005 R	1 Secchio 25 lt	●
4100PR	1 Strizzatore in plastica	●
2023 A	1 Vassoio MINIMAX	●
2024 A	1 Vassoio mini	●

 55x45x97h cm











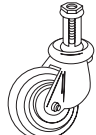

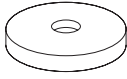

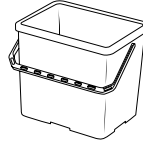

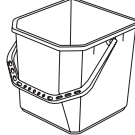
1 Pz/cartone 16,5 Kg 0,290 m³
1 Pz/cartone 14,2 Kg 0,290 m³

 55x45x110h cm

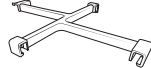
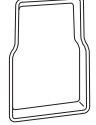
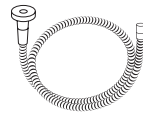

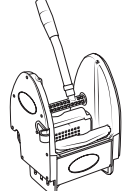
1 Pz/cartone 18,6 Kg 0,290 m³
1 Pz/cartone 16,5 Kg 0,290 m³

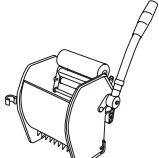
Codice	Descrizione	Colore	Codice	Descrizione	Colore
 GR1385	Reggisacco MINIMAX con gomma		 1430	Ruota Ø 80 mm con espansore e parafile	
 1386	Anello in gomma piccolo		 1031	Paracolpi piccolo	●
 1382	Astina filettata per MINIMAX 2-3		 2250 A 2250 R	Secchio 6 lt	● ●
 1380	Astina intera per MINIMAX 2-3		 1005 R	Secchio 25 lt	●
 GR1388	Portavassoio MINIMAX con tappi		 2252	Coperchio per secchio 6 lt	●
 2024 A	Vassoio mini	●	 2253	Separatore flaconi per secchio 6 lt	●
 2023 A	Vassoio MINIMAX	●	 1071	Convogliatore acqua FAST	
 1387	Alberino MINIMAX 2 per ruota fissa Ø 200 mm		 4100PR	Strizzatore in plastica	●
 1696	Ruota fissa Ø 200 mm		 3501 VDM	Strizzatore a rullo ELPAROLL	



Codice	Descrizione	Colore
L 1.75.80	Carrello multiuso "piccolo" cromato	
GR1615	1 Base cromata 75x44 cm con 4 ruote Ø 80 mm (art. 1030) e paracolpi	
GR1625	1 Spalla multiuso con reggisacco e anello in gomma	
1610	1 Coperchio quadrato	●
2235 A	1 Secchio 12 lt	●
2235 R	1 Secchio 12 lt	●
1665	1 Cestello portaoggetti multiuso	
1670	1 Cestello portasecchi multiuso	
1675	1 Portascopa multiuso	
KITMULTIUSO/A	1 Kit montaggio L 1.50.80 - L 1.75.80	



Codice	Descrizione	Colore
LP 2.75.80	Carrello multiuso "plus" cromato	
LP 2.75.80 S/P	Carrello multiuso "plus" cromato senza pressa	
GR1617	1 Base cromata 75x44 cm "plus" con 4 ruote Ø 80 mm (art. 1030) e paracolpi	
GR1625	1 Spalla multiuso con reggisacco e anello in gomma	
1610	1 Coperchio quadrato	●
2235 A	1 Secchio 12 lt	●
2235 R	1 Secchio 12 lt	●
1666	1 Cestello portaoggetti "plus"	
1675	1 Portascopa multiuso	
1985	1 Verticale portapressa 2x15 lt	
4100PR	1 Strizzatore in plastica	●
KITMULTIUSO/D	1 Kit montaggio LP 2.75.80	

75x44x103h cm	1 Pz/cartone	13,6 Kg	0,150 m ³
---------------	--------------	---------	----------------------

75x44x103h cm	1 Pz/cartone	18,8 Kg	0,190 m ³
	1 Pz/cartone	16,5 Kg	0,150 m ³













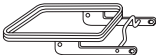
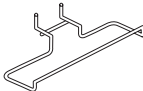
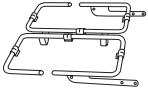

Codice	Descrizione	Colore
--------	-------------	--------





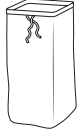

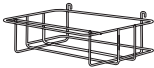

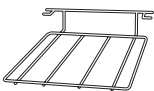
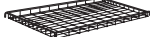
L 2.125.100 Carrello multiuso "maxi" cromato

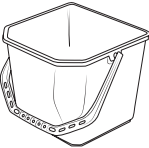
L 2.125.100 S/P Carrello multiuso "maxi" cromato senza pressa

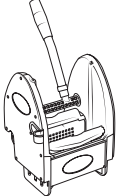
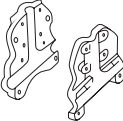
GR2415/MAXI	1 Base cromata 100x44 cm con 4 ruote Ø 100 mm (art. 2030) ganci carrello e paracolpi	
GR1220	1 Telaio E/EMF 2x15 completo di 4 ruote Ø 80 mm (art. 1030) e paracolpi	
GR1625	1 Spalla multiuso con reggisacco e anello in gomma	
GR1625/TOP	1 Spalla multiuso senza reggisacco	
1610	1 Coperchio quadrato	●
2225	1 Portasacco multiuso	
1675	1 Portascopa multiuso	
2020	2 Ripiani per vassoi piccoli	
1205 A	1 Secchio 15 lt	●
1205 R	1 Secchio 15 lt	●
4100PR	1 Strizzatore in plastica	●
KITMULTIUSO/F	1 Kit montaggio L 2.125.100	

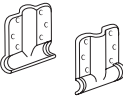
 125x44x105h cm	1 Pz/cartone	26 Kg	0,290 m ³
	1 Pz/cartone	23,7 Kg	0,290 m ³

Codice	Descrizione	Colore	Codice	Descrizione	Colore
 GR1620	Reggisacco multiuso con gomma		 1675	Portascopa multiuso	
 1624	Reggisacco DUOx70lt		 1640	Astina filettata multiuso	
 1622	Anello in gomma grande		 1630	Astina intera multiuso	
 1621	Clip fermasacco	●	 KIT2230	Kit portamanico completo di aggancio Ø 22 mm	●
 1610	Coperchio quadrato	●	 1677 B 1677 R	Sacco nylon 120 lt (72x100 cm)	● ●
 1665	Cestello portaoggetti multiuso		 1678 B 1678 R	Sacco nylon 70 lt (52x100 cm)	● ●
 1666	Cestello portaoggetti "plus"		 1680	Sacco in cotone sanforizzato 120 lt	
 1670	Cestello portasecchi multiuso		 1680/G	Sacco in cotone sanforizzato 230 lt	
 2225	Portasacco multiuso		 2020	Ripiano per vassoio piccolo	

Codice	Descrizione	Colore	Codice	Descrizione	Colore
	2220 Ripiano per vassoio grande			1205 A 1205 R Secchio 15 lt	● ●
	1641 Astina non filettata multiuso 6x436 mm			4100PR Strizzatore in plastica	●
	KIT1735 Kit coppia flange plastica	●			
	2101 Kit PED completo				
	KIT1635 Kit piastra di fissaggio metallo	●			
	1030 Ruota Ø 80 mm con filetto 8x28 e parafilo				
	2030 Ruota Ø 100 mm con filetto 8x28 e parafilo				
	1031 Paracolpi piccolo	●			
	2235 A 2235 R Secchio 12 lt	● ●			













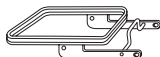
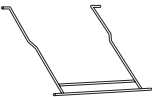

Codice	Descrizione	Colore
HO 8001	Carrello HO cromato	
HO 8001 S/P	Carrello HO cromato senza pressa	
GR8051	1 Base HO 8001/8002 completa di 4 ruote Ø 100 mm (art. 2030) con filetto	
4504	1 Spalla HO 8001 - 2 fori senza reggisacco	
GR4503	1 Spalla HO 8001 - 5 fori con reggisacco	
1675	1 Portascopa multiuso	
GR8053	2 Portavassoi HO con astine	
2250 A	1 Secchio 6 lt	●
2250 G	1 Secchio 6 lt	●
2250 R	1 Secchio 6 lt	●
2250 VS	1 Secchio 6 lt	●
1205 A	1 Secchio 15 lt	●
1205 R	1 Secchio 15 lt	●
1980	1 Verticale portapressa 2x25 lt	●
4100PR	1 Strizzatore in plastica	●
2027 A	2 Vassoi medi	●
2027 R	1 Vassoio medio	●
KITHO/A	1 Kit montaggio con 2 portamanico (art. KIT2230)	●

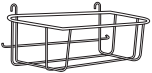

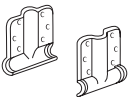
Codice	Descrizione	Colore
HO 8002	Carrello HO cromato	
HO 8002 S/P	Carrello HO cromato senza pressa	
GR8051	1 Base HO 8001/8002 completa di 4 ruote Ø 100 mm (art. 2030) con filetto	
GR4502	1 Spalla HO 8002 - 3 fori con reggisacco	
7045	1 Cestello portaoggetti EF/HO	
7036	1 Cestello portasecchi EF/HO	
1675	1 Portascopa multiuso	
2250 A	1 Secchio 6 lt	●
2250 R	1 Secchio 6 lt	●
1205 A	1 Secchio 15 lt	●
1205 R	1 Secchio 15 lt	●
1980	1 Verticale portapressa 2x25 lt	●
4100PR	1 Strizzatore in plastica	●
KITHO/B	1 Kit montaggio con 2 portamanico (art. KIT2230)	●

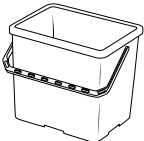
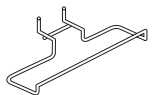
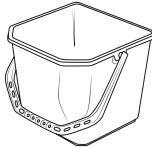
120x50x105h cm	1 Pz/cartone	28,7 Kg	0,250 m ³
	1 Pz/cartone	26,4 Kg	0,250 m ³

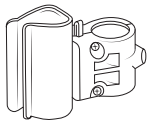
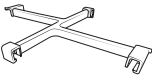
95x50x105h cm	1 Pz/cartone	21,2 Kg	0,240 m ³
	1 Pz/cartone	19 Kg	0,240 m ³

Codice	Descrizione	Colore	Codice	Descrizione	Colore
 GR7043	Reggisacco EF/HO con anello in gomma		 7042	Astina intera EF/HO	
 2710	Cursore compl. per reggisacco rett. (con 2 clip art. 1701)	● ●	 7045	Cestello portaoggetti EF/HO	
 7031	Coperchio rettangolare	●	 7036	Cestello portasecchi EF/HO	
 1622	Anello in gomma grande		 KIT1635	Kit piastra di fissaggio metallo	●
 GR8055	Portasacco HO con astina		 2250 A 2250 G 2250 R 2250 VS	Secchio 6 lt	● ● ● ●
 1675	Portascopa multiuso		 1205 A 1205 R	Secchio 15 lt	● ●
 GR8053	Portavassoio HO con astine		 2252	Coperchio per secchio 6 lt	●
 KIT2230	Kit portamanico completo di aggancio Ø 22 mm	●	 2253	Separatore flaconi per secchio 6 lt	●
 7041	Astina filettata EF/HO		 2030	Ruota Ø 100 mm con filetto 8x28 e parafilo	

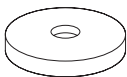
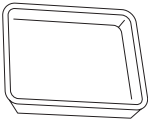
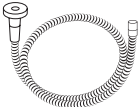
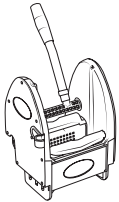
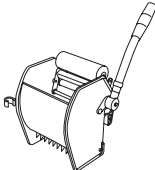
	Codice	Descrizione	Colore
	1031	Paracolpi piccolo	●
	2027 A 2027 R	Vassoio medio	● ●
	1071	Convogliatore acqua FAST	
	4100PR	Strizzatore in plastica	●
	3501 VDM	Strizzatore a rullo ELPAROLL	





Codice	Descrizione	Colore
JOKER 1	Carrello JOKER cromato	
GR8201	1 Base JOKER 1-2-3 completa di 4 ruote Ø 80 mm (art. 1430) con espansore	
GR8203	1 Spalla JOKER con maniglia	
GR8202	1 Spalla JOKER	
GR8204	1 Reggisacco 70 lt JOKER rilsan con clip fermasacco	
8311	1 Portamanico piccolo	●
8303	1 Portascopa JOKER	●
GR8205	2 Portavassoi mini JOKER con viti	●
2250 A	1 Secchio 6 lt	●
2250 R	1 Secchio 6 lt	●
2024 A	2 Vassoi mini	●
2024 R	1 Vassoio mini	●
KITJOKER/A	1 Kit montaggio JOKER 1-2	●

Codice	Descrizione	Colore
JOKER 2	Carrello JOKER cromato	
GR8201	1 Base JOKER 1-2-3 completa di 4 ruote Ø 80 mm (art. 1430) con espansore	
GR8202	2 Spalle JOKER	
GR8204	2 Reggisacco 70 lt JOKER rilsan con clip fermasacco	
GR8206	1 Portasacco 70 lt JOKER	
8311	1 Portamanico piccolo	●
8303	1 Portascopa JOKER	●
GR8205	2 Portavassoi mini JOKER con viti	●
2024 A	2 Vassoi mini	●
2024 R	1 Vassoio mini	●
KITJOKER/A	1 Kit montaggio JOKER 1-2	●

 75x40x103h cm |  1 Pz/cartone 15 Kg 0,150 m³

 100x44x103h cm |  1 Pz/cartone 16 Kg 0,150 m³



Codice	Descrizione	Colore
--------	-------------	--------

JOKER 3 Carrello JOKER cromato

JOKER 3 S/P Carrello JOKER cromato senza pressa

GR8201	1 Base JOKER 1-2-3 completa di 4 ruote Ø 80 mm (art. 1430) con espansore	
GR8202	2 Spalle JOKER	
GR8204	1 Reggisacco 70 lt JOKER rilsan con clip fermasacco	
GR8206	1 Portasacco 70 lt JOKER	
8311	1 Portamanico piccolo	●
8303	1 Portascopa JOKER	●
GR8205	2 Portavassoi mini JOKER con viti	●
2250 A	1 Secchio 6 lt	●
2250 R	1 Secchio 6 lt	●
2235 A	1 Secchio 12 lt	●
2235 R	1 Secchio 12 lt	●
GR8207	1 Portapressa 2x12 lt JOKER	
4100PR	1 Strizzatore in plastica	●
2024 A	2 Vassoi mini	●
2024 R	1 Vassoio mini	●
KITJOKER/B	1 Kit montaggio JOKER 3-4-5-6	

Codice	Descrizione	Colore
--------	-------------	--------

JOKER 4 Carrello JOKER cromato

JOKER 4 S/P Carrello JOKER cromato senza pressa

GR8305	1 Base JOKER 4 completa di 4 ruote Ø 100 mm (art. 2034) con espansore e paracolpi	
GR8202	2 Spalle JOKER	
GR8204	1 Reggisacco 70 lt JOKER rilsan con clip fermasacco	
GR8206	1 Portasacco 70 lt JOKER	
8311	1 Portamanico piccolo	●
8303	1 Portascopa JOKER	●
GR8205	2 Portavassoi mini JOKER con viti	●
2250 A	1 Secchio 6 lt	●
2250 R	1 Secchio 6 lt	●
1205 A	1 Secchio 15 lt	●
1205 R	1 Secchio 15 lt	●
GR8304	1 Portapressa 2x15 lt JOKER	
4100PR	1 Strizzatore in plastica	●
2024 A	2 Vassoi mini	●
2024 R	1 Vassoio mini	●
KITJOKER/B	1 Kit montaggio JOKER 3-4-5-6	

100x40x103h cm	1 Pz/cartone	20,5 Kg	0,190 m ³
	1 Pz/cartone	18,2 Kg	0,190 m ³

100x60x105h cm	1 Pz/cartone	23,2 Kg	0,240 m ³
	1 Pz/cartone	21 Kg	0,240 m ³



Codice	Descrizione	Colore
JOKER 5	Carrello JOKER cromato	
JOKER 5 S/P	Carrello JOKER cromato senza pressa	
GR8301	1 Base JOKER 5 completa di 4 ruote Ø 100 mm (art. 2034) con espansore e paracolpi	
GR8202	2 Spalle JOKER	
GR5013	1 Reggisacco 120 lt H/JOKER con clip fermasacco e attacco coperchio (art. 7031)	
GR5014	1 Portasacco 120 lt H/JOKER	
8310	2 Portamanico grande	●
GR5025	2 Portavassoi piccoli H/JOKER con viti	●
1205 A	1 Secchio 15 lt	●
1205 R	1 Secchio 15 lt	●
GR8304	1 Portapressa 2x15 lt JOKER	●
4100PR	1 Strizzatore in plastica	●
2025 A	2 Vassoi piccoli	●
2025 R	1 Vassoio piccolo	●
KITJOKER/B	1 Kit montaggio con 1 portamanico (art. KIT5018) JOKER 3-4-5-6	●



Codice	Descrizione	Colore
JOKER 6	Carrello JOKER cromato	
JOKER 6 S/P	Carrello JOKER cromato senza pressa	
GR8312	1 Base JOKER 6-7 completa di 4 ruote Ø 100 mm (art. 2034) con espansore e paracolpi	
GR8202	2 Spalle JOKER	
GR5013	1 Reggisacco 120 lt H/JOKER con clip fermasacco e attacco coperchio (art. 7031)	
GR5014	1 Portasacco 120 lt H/JOKER	
8310	1 Portamanico grande	●
GR5025	2 Portavassoi piccoli H/JOKER con viti	●
1205 R	1 Secchio 15 lt	●
GR8304	1 Portapressa 2x15 lt JOKER	●
4100PR	1 Strizzatore in plastica	●
2025 A	2 Vassoi piccoli	●
2025 R	1 Vassoio piccolo	●
KITJOKER/B	1 Kit montaggio con 1 portamanico (art. KIT5018) JOKER 3-4-5-6	●

110x60x105h cm	1 Pz/cartone	24,5 Kg	0,250 m ³
	1 Pz/cartone	22,2 Kg	0,250 m ³

110x45x105h cm	1 Pz/cartone	23,1 Kg	0,250 m ³
	1 Pz/cartone	20,8 Kg	0,250 m ³











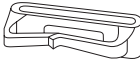
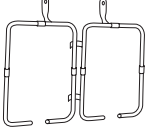
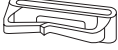

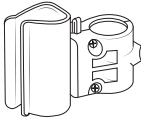
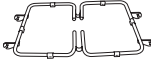
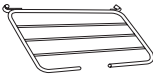
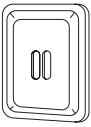



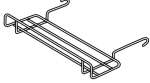
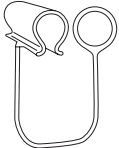
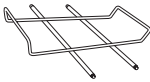
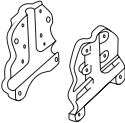
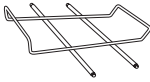

Codice	Descrizione	Colore
JOKER 7	Carrello JOKER cromato	
GR8312	1 Base JOKER 6-7 completa di 4 ruote Ø 100 mm (art. 2034) con espansore e paracolpi	
GR8202	2 Spalle JOKER	
GR5013	1 Reggisacco 120 lt H/JOKER con clip fermasacco e attacco coperchio (art. 7031)	
5017	1 Portascopa H	
GR5025	2 Portavassoi piccoli H/JOKER con viti	
2025 A	2 Vassoi piccoli	●
2025 R	1 Vassoio piccolo	●
KITJOKER/C	1 Kit montaggio con 2 portamanico (art. KIT5018) JOKER 7	

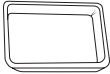
Codice	Descrizione	Colore
JOKER TRIO	Carrello TRIO (3x120 lt) cromato	
GR8201/T	1 Base JOKER TRIO completa di 4 ruote Ø 100 mm (art. 2034) con espansore e paracolpi	
GR8202	2 Spalle JOKER	
GR8204	1 Reggisacco 70 lt JOKER con clip fermasacco	
GR8204/T	1 Reggisacco doppio JOKER TRIO con clip fermasacco	
GR8206	1 Portasacco 70 lt JOKER	
KITJOKER/D	1 Kit montaggio JOKER TRIO	

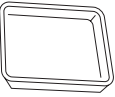
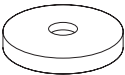
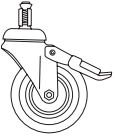
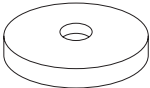
80x45x105h cm	1 Pz/cartone	17 Kg	0,150 m ³
---------------	--------------	-------	----------------------

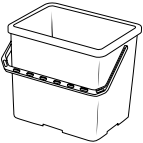
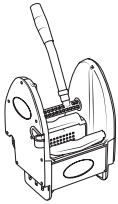
115x50x106h cm	1 Pz/cartone	15,2 Kg	0,150 m ³
----------------	--------------	---------	----------------------

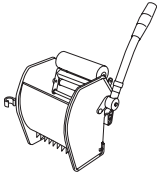
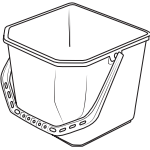
	Codice	Descrizione	Colore		Codice	Descrizione	Colore
	GR5013	Reggisacco 120 lt H/JOKER con clip fermasacco			8310	Portamanico grande	●
	GR5027	Reggisacco DUO 70 lt JOKER/H con clip fermasacco			8311	Portamanico piccolo	●
	GR8204	Reggisacco 70 lt JOKER rilsan con clip fermasacco			KIT5018	Kit portamanico completo di aggancio Ø 20 mm	●
	GR8204/T	Reggisacco doppio JOKER TRIO con clip fermasacco			GR5014	Portasacco 120 lt H/JOKER	
	5051/B 5051/R	Coperchio per reggisacco DUO (art. GR5027)	● ●		GR8206	Portasacco 70 lt JOKER	
	7031	Coperchio rettangolare	●		5017	Portascopa H	
	1621	Clip fermasacco	●		8303	Portascopa JOKER	
	1701	Clip fermasacco con anello	●		GR8205	Portavassoio mini JOKER con viti	
	KIT1735	Kit coppia flange plastica	●		GR5025	Portavassoio piccolo H/JOKER con viti	

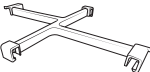
Codice	Descrizione	Colore	Codice	Descrizione	Colore
	2034 Ruota Ø 100 mm con espansore e parafile			2024 A 2024 R Vassoio mini	● ●
	1430 Ruota Ø 80 mm con espansore e parafile			2025 A 2025 R Vassoio piccolo	● ●
	1031 Paracolpi piccolo	●		2032 Ruota Ø 100 mm speciale c/freno senza espansore	
	1036 Paracolpi grande	●		2033 Ruota Ø 100 mm speciale s/freno senza espansore	
	2250 A 2250 R Secchio 6 lt	● ●		4100PR Strizzatore in plastica	●
	2235 A 2235 R Secchio 12 lt	● ●		3501 VDM Strizzatore a rullo ELPAROLL	
	1205 A 1205 R Secchio 15 lt	● ●			
	2252 Coperchio per secchio 6 lt	●			
	2253 Separatore fiacconi per secchio 6 lt	●			



Codice	Descrizione	Colore
H 5001	Carrello H cromato	
H 5001 S/P	Carrello H cromato senza pressa	
GR5000B	1 Base H grande con 4 ruote Ø 100 mm (art. 2034) con espansore e paracolpi	
GR5000S	2 Spalle H	
GR5013	1 Reggisacco 120 lt H/JOKER con clip fermasacco e attacco coperchio (art. 7031)	
5010	2 Spondine H	
GR5014	1 Portasacco 120 lt H/JOKER	
5017	1 Portascopa H	
GR5011	4 Aste portacestelli H con viti	
5012	2 Cestelli grandi H	
5024	1 Fermaflaconi H	
1205 A	1 Secchio 15 lt	●
1205 R	1 Secchio 15 lt	●
GR5019	1 Portapressa H completo di viti	
4100PR	1 Strizzatore in plastica	●
KITH	1 Kit montaggio con 2 portamanico (art. KIT5018) linea H	

Fino ad esaurimento scorte



Codice	Descrizione	Colore
H 5006	Carrello H cromato	
GR5000B	1 Base H grande con 4 ruote Ø 100 mm (art. 2034) con espansore e paracolpi	
GR5000S	2 Spalle H	
GR5013	1 Reggisacco 120 lt H/JOKER con clip fermasacco e attacco coperchio (art. 7031)	
5010	2 Spondine H	
GR5014	1 Portasacco 120 lt H/JOKER	
5017	1 Portascopa H	
5023	2 Ripiani portavassoi grandi H	
KITH	1 Kit montaggio con 2 portamanico (art. KIT5018) linea H	

Fino ad esaurimento scorte

110x60x105h cm



1 Pz/cartone 29,2 Kg 0,290 m³
1 Pz/cartone 27 Kg 0,290 m³

110x60x105h cm



1 Pz/cartone 21,7 Kg 0,150 m³



Codice	Descrizione	Colore
--------	-------------	--------

H 5007

Carrello H cromato

- GR5030B 1 Base H piccola con 4 ruote
Ø 100 mm (art. 2034) con espansore e paracolpi
- GR5000S 2 Spalle H
- 5017 1 Portascopa H
- GR5025 2 Portavassoi piccoli H/JOKER con viti
- 2025 A 2 Vassoi piccoli
- 2025 R 1 Vassoio piccolo
- KITH 1 Kit montaggio con 2 portamanico
(art. KIT5018) linea H



Codice	Descrizione	Colore
--------	-------------	--------

H 5008











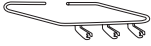

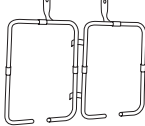

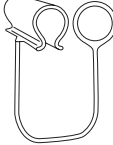
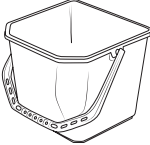
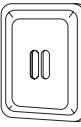

Carrello H cromato

- GR5030B 1 Base H piccola con 4 ruote
Ø 100 mm (art. 2034) con espansore e paracolpi
- GR5000S 2 Spalle H
- GR5013 1 Reggisacco 120 lt H/JOKER con clip fermasacco
e attacco coperchio (art. 7031)
- 5017 1 Portasacco 120 lt H/JOKER
- GR5025 1 Portascopa H
- 2025 A 2 Portavassoi piccoli H/JOKER con viti
- 2025 R 2 Vassoi piccoli
- KITH 1 Vassoio piccolo
- 1 Kit montaggio con 2 portamanico
(art. KIT5018) linea H

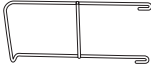

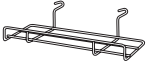
45x50x105h cm	1 Pz/cartone	16,5 Kg	0,150 m ³
---------------	--------------	---------	----------------------

80x45x105h cm	1 Pz/cartone	17,8 Kg	0,150 m ³
---------------	--------------	---------	----------------------

Codice	Descrizione	Colore	Codice	Descrizione	Colore
	GR5013 Reggisacco 120 Lt H/JOKER con clip fermasacco			5023 Ripiano portavassoio grande H	
	GR5027 Reggisacco DUO 70 Lt JOKER/H con clip fermasacco			GR5025 Portavassoio piccolo H/JOKER con viti	
	GR5014 Portasacco 120 Lt H/JOKER			GR5011 Asta portacestelli H con viti	
	1701 Clip fermasacco con anello	●		1205 A 1205 R Secchio 15 lt	● ●
	5051/B 5051/R Coperchio per reggisacco DUO (art. GR5027)	● ●		2025 A 2025 R Vassoio piccolo	● ●
	7031 Coperchio rettangolare	●		2034 Ruota Ø 100 mm con espansore e parafilo	
	5024 Fermafiaconi H			1031 Paracolpi piccolo	●
	5017 Portascopa H			5012 Cestello grande H	
	KIT5018 Kit portamanico completo di aggancio Ø 20 mm	●		GR5019 Portapressa H completo di viti	

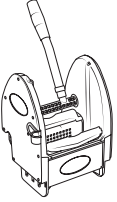
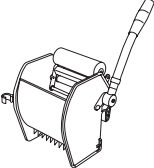
Codice	Descrizione	Colore
 4100PR	Strizzatore in plastica	●
 3501 VDM	Strizzatore a rullo ELPAROLL	



Codice	Descrizione	Colore
--------	-------------	--------

EF 7051 Carrello EF cromato

EF 7051 S/P Carrello EF cromato senza pressa

- GR7050 1 Base EF grande con 4 ruote Ø 100 mm (art. 2034) con espansore e paracolpi
- GR7060/STD 1 Spalla EF senza reggisacco
- 1675 1 Portascopa multiuso
- 7040 1 Cestello grande EF
- 2235 A 1 Secchio 12 lt
- 2235 R 1 Secchio 12 lt
- 7030 A 1 Secchio rett. 22 lt
- 7030 R 1 Secchio rett. 22 lt
- 7009 1 Frangia di lavaggio EF - 40x10 cm (codice colore)
- 4020 1 Manico cromato Ø 22 mm, 145 cm con foro (2 pezzi)
- 7008 1 Telaio inox (40x10 cm)
- 7001 1 Strizzatore in acciaio inox
- KITEF 1 Kit montaggio con 1 portamanico (art. KIT2230) linea EF



Codice	Descrizione	Colore
--------	-------------	--------

EF 7052 Carrello EF cromato

EF 7052 S/P Carrello EF cromato senza pressa

- GR7050 1 Base EF grande con 4 ruote Ø 100 mm (art. 2034) con espansore e paracolpi
- GR7060/STD 1 Spalla EF senza reggisacco
- 1675 1 Portascopa multiuso
- 7040 2 Cestelli grandi EF
- 2235 A 1 Secchio 12 lt
- 2235 R 1 Secchio 12 lt
- 7030 A 1 Secchio rett. 22 lt
- 7030 R 1 Secchio rett. 22 lt
- 7009 1 Frangia di lavaggio EF - 40x10 cm (codice colore)
- 4020 1 Manico cromato Ø 22 mm, 145 cm con foro (2 pezzi)
- 7008 1 Telaio inox (40x10 cm)
- 7001 1 Strizzatore in acciaio inox
- 5024 1 Fermaflaconi H
- KITEF 1 Kit montaggio con 1 portamanico (art. KIT2230) linea EF



75x55x105h cm	1 Pz/cartone	25 Kg	0,250 m ³
	1 Pz/cartone	18,2 Kg	0,250 m ³

75x55x105h cm	1 Pz/cartone	26,5 Kg	0,250 m ³
	1 Pz/cartone	19,7 Kg	0,250 m ³



Codice	Descrizione	Colore
--------	-------------	--------

EF 7053 Carrello EF cromato

EF 7053 S/P Carrello EF cromato senza pressa

GR7050	1 Base EF grande con 4 ruote Ø 100 mm (art. 2034) con espansore e paracolpi	
GR7060/7053	1 Spalla EF con reggisacco	
1675	1 Portascopa multiuso	
7040	1 Cestello grande EF	
7045	1 Cestello portaoggetti EF/HO	
7030 A	1 Secchio rett. 22 lt	●
7030 R	1 Secchio rett. 22 lt	●
7009	1 Frangia di lavaggio EF - 40x10 cm (codice colore)	
4020	1 Manico cromato Ø 22 mm, 145 cm con foro (2 pezzi)	
7008	1 Telaio inox (40x10 cm)	
7001	1 Strizzatore in acciaio inox	
KITEF	1 Kit montaggio con 1 portamanico (art. KIT2230) linea EF	

Codice	Descrizione	Colore
--------	-------------	--------









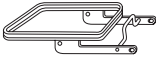
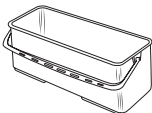

EF 7054 Carrello EF cromato

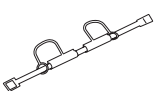
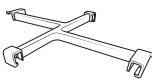
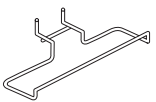

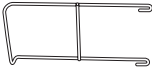
EF 7054 S/P Carrello EF cromato senza pressa

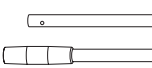
GR7051	1 Base EF piccola con 4 ruote Ø 100 mm (art. 2034) con espansore e paracolpi	
GR7060/STD	1 Spalla EF senza reggisacco	
1675	1 Portascopa multiuso	
7036	1 Cestello portasecchi EF/HO	
2250 A	1 Secchio 6 lt	●
2250 R	1 Secchio 6 lt	●
7030 R	1 Secchio rett. 22 lt	●
7009	1 Frangia di lavaggio EF - 40x10 cm (codice colore)	
4020	1 Manico cromato Ø 22 mm, 145 cm con foro (2 pezzi)	
7008	1 Telaio inox (40x10 cm)	
7001	1 Strizzatore in acciaio inox	
KITEF	1 Kit montaggio con 1 portamanico (art. KIT2230) linea EF	

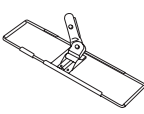
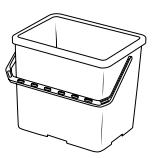
100x55x105h cm	1 Pz/cartone	26 Kg	0,250 m ³
	1 Pz/cartone	19,2 Kg	0,250 m ³

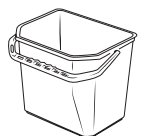
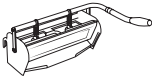
50x55x105h cm	1 Pz/cartone	21,6 Kg	0,250 m ³
	1 Pz/cartone	14,8 Kg	0,250 m ³

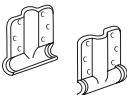
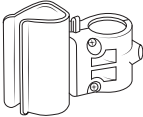
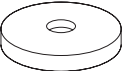
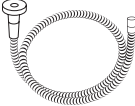
	Codice	Descrizione	Colore		Codice	Descrizione	Colore
	GR7043	Reggisacco EF/HO con anello in gomma			7030 A 7030 R	Secchio rett. 22 lt	● ●
	1622	Anello in gomma grande			2252	Coperchio per secchio 6 lt	●
	2710	Cursore compl. per reggisacco rett. (con 2 clip art. 1701)	● ●		2253	Separatore flaconi per secchio 6 lt	●
	1675	Portascopa multiuso			7038	Coperchio per secchio rett. 22 lt	●
	7036	Cestello portasecchi EF/HO			5024	Fermaflaconi H	
	7040	Cestello grande EF			4020	Manico cromato Ø 22 mm, 145 cm con foro (2 pezzi)	
	7045	Cestello portaoggetti EF/HO			7008	Telaio inox (40x10 cm)	
	2250 A 2250 R	Secchio 6 lt	● ●		7009	Frangia di lavaggio EF 40x10 cm (codice colore)	
	2235 A 2235 R	Secchio 12 lt	● ●		7001	Strizzatore in acciaio inox	

	Codice	Descrizione	Colore
	KIT1635	Kit piastra di fissaggio metallo	●
	KIT2230	Kit portamanico completo di aggancio Ø 22 mm	●
	1031	Paracolpi piccolo	●
	1071	Convogliatore acqua FAST	
	2034	Ruota Ø 100 mm con espansore e parafilo	
	7041	Astina filettata EF/HO	



Multiuso con Protezione Rilsan

EUROPE 146

BIO-R 147

Multiuso con Protezione Rilsan





Protezione Rilsan VDM. Eccellenza esclusiva VDM è la speciale protezione Rilsan ad immersione in letto fluido (film protettivo approntato 400 micron) che garantisce un'elevata durata nel tempo.



Capacità di carico. Ampi spazi di carico in dimensioni ridotte.

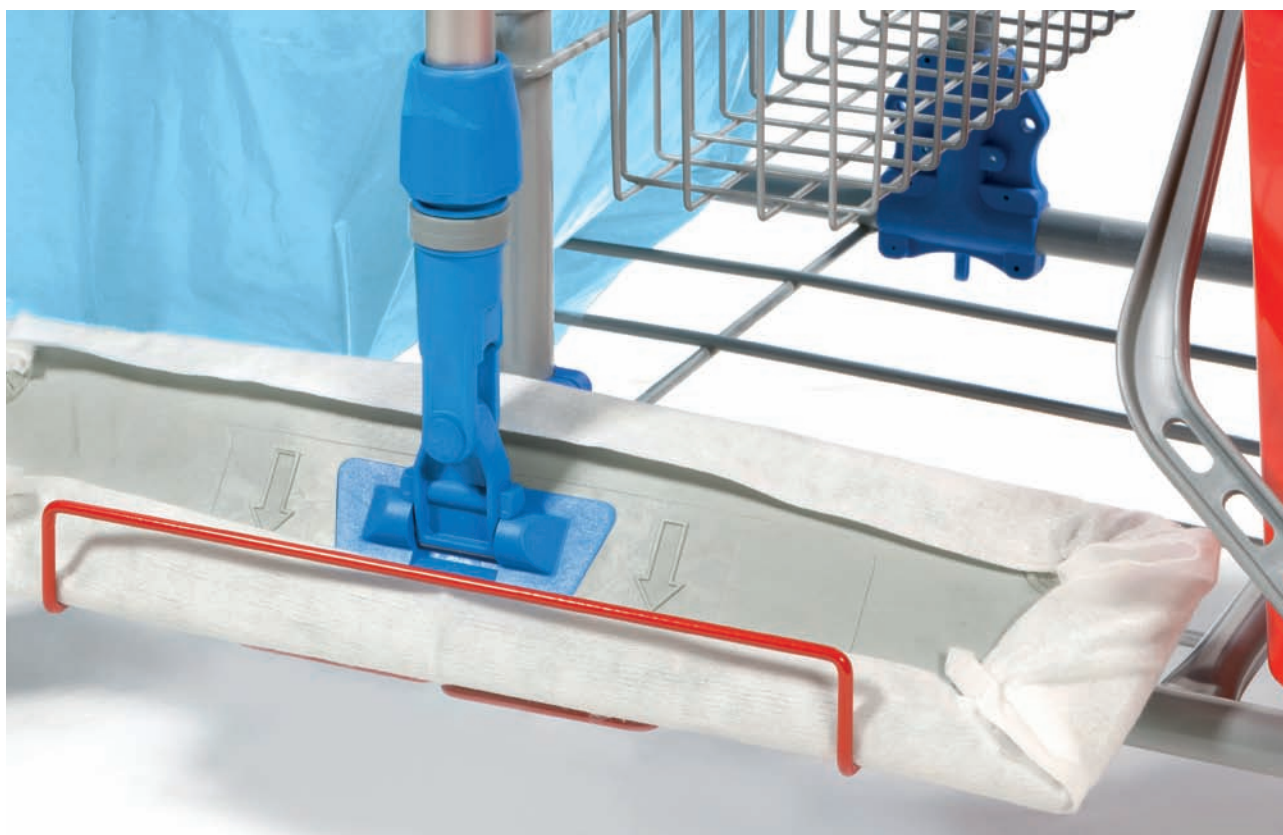

Funzionalità. Portascopa integrato nel carrello per una maggiore funzionalità.



Codice	Descrizione	Colore
EUROPE	Carrello EUROPE con rivestimento in rilsan	
GR1530/R	1 Base EUROPE in rilsan completa di 4 ruote Ø 80 mm (art. 1030/ZE) e paracolpi	
GR1533/R	1 Spalla EUROPE completa di anello in gomma piccolo	
1666/R	1 Cestello portaoggetti in rilsan EUROPE/IDEABASE	
1535/R	1 Cestello portasecchi in rilsan EUROPE/IDEABASE	
8311	1 Portamanico piccolo	●
2250 A	1 Secchio 6 lt	●
2250 R	1 Secchio 6 lt	●
2023 A	1 Vassoio MINIMAX	●
KITEUROPE/A	1 Kit montaggio EUROPE	●

Codice	Descrizione	Colore
EUROPE 2	Carrello EUROPE con rivestimento in rilsan	
EUROPE 2 S/P	Carrello EUROPE con rivestimento in rilsan senza pressa	
GR8051/R	1 Base EUROPE 2 in rilsan completa di 4 ruote Ø 100 mm (art. 2030) con filetto 8x28 e paracolpi piccoli	
GR8052/R	1 Spalla EUROPE 2 in rilsan	
7045/R	1 Cestello portaoggetti EUROPE 2 in rilsan	
7036/R	1 Cestello portasecchi EUROPE 2 in rilsan	
1675	1 Portascopa multiuso	
2250 A	1 Secchio 6 lt	●
2250 R	1 Secchio 6 lt	●
1205 A	1 Secchio 15 lt	●
1205 R	1 Secchio 15 lt	●
1980/R	1 Verticale portapressa 2x25 lt in rilsan	●
4100PR	1 Strizzatore in plastica	●
KITEUROPE/B	1 Kit montaggio EUROPE con 1 portamanico (art. KIT2230)	●

68x45x100h cm	2 Pz/cartone	22 Kg	0,190 m ³
---------------	--------------	-------	----------------------

95x50x105h cm	1 Pz/cartone	20,7 Kg	0,250 m ³
	1 Pz/cartone	18,4 Kg	0,250 m ³

Optional (raffigurati in foto)

7031 B Coperchio rettangolare ●



Codice	Descrizione	Colore
--------	-------------	--------

BIO-R 1 Carrello BIO R con rivestimento in rilsan

BIO-R 1 S/E Carrello BIO R con rivestimento in rilsan senza sistema ELPAROLL

GR8301/R	1 Base BIO-R 1 in rilsan completa di 4 ruote Ø 100 mm (art. 2034) con espansore e paracolpi	
GR8202/R	2 Spalle BIO-R in rilsan	
GR5013/R	1 Reggisacco 120 lt BIO-R in rilsan completo di clip fermasacco e attacco coperchio (art. 7031)	
8310	2 Portamanico grande	●
GR5014/R	1 Portasacco 120 lt BIO-R in rilsan	
GR8306/R	2 Portavassoio medio BIO-R 1 in rilsan	
3503	1 Frangia di lavaggio ELPAROLL 45x10 cm	
4020	1 Manico cromato Ø 22 mm, 145 cm con foro (2 pezzi)	
3502	1 Telaio di lavaggio ELPAROLL 45x10 cm	
2250 A	1 Secchio 6 lt	●
2250 G	1 Secchio 6 lt	●
2250 R	1 Secchio 6 lt	●
2250 VS	1 Secchio 6 lt	●
1205 A	1 Secchio 15 lt	●
1205 R	1 Secchio 15 lt	●
2027 A	1 Vassoio medio	●
2027 R	1 Vassoio medio	●
2025 A	1 Vassoio piccolo	●
GR8304/R	1 Portapressa 2x15 lt BIO-R in rilsan	
3501 VDM	1 Strizzatore a rullo ELPAROLL	
KITBIOR/A	1 Kit montaggio BIO-R con 1 portamanico (art. KIT5018)	

Codice	Descrizione	Colore
--------	-------------	--------

BIO-R 2 Carrello BIO R con rivestimento in rilsan

BIO-R 2 S/E Carrello BIO R con rivestimento in rilsan senza sistema ELPAROLL

GR8305/R	1 Base BIO-R 2 in rilsan completa di 4 ruote Ø 100 mm (art. 2034) con espansore e paracolpi	
GR8202/R	2 Spalle BIO-R in rilsan	
GR8204/R	1 Reggisacco 70 lt BIO-R in rilsan con clip fermasacco	
8311	1 Portamanico piccolo	●
GR8206/R	1 Portasacco 70 lt BIO-R in rilsan	
8303/R	1 Portascopa BIO-R	
GR8205/R	2 Portavassoio mini BIO-R in rilsan	
3503	1 Frangia di lavaggio ELPAROLL 45x10 cm	
4020	1 Manico cromato Ø 22 mm, 145 cm con foro (2 pezzi)	
3502	1 Telaio di lavaggio ELPAROLL 45x10 cm	
2250 A	1 Secchio 6 lt	●
2250 R	1 Secchio 6 lt	●
1205 A	1 Secchio 15 lt	●
1205 R	1 Secchio 15 lt	●
2024 A	2 Vassoi mini	●
2024 R	1 Vassoio mini	●
3501 VDM	1 Strizzatore a rullo ELPAROLL	
GR8304/R	1 Portapressa 2x15 lt BIO-R in rilsan	
KITBIOR/A	1 Kit montaggio BIO-R con 1 portamanico (art. KIT5018)	

110x60x105h cm	1 Pz/cartone	29,8 Kg	0,250 m ³
	1 Pz/cartone	25,5 Kg	0,250 m ³

100x60x105h cm	1 Pz/cartone	25,6 Kg	0,250 m ³
	1 Pz/cartone	21,5 Kg	0,250 m ³



Codice	Descrizione	Colore
--------	-------------	--------

BIO-R 3 Carrello BIO R con rivestimento in rilsan

BIO-R 3 S/E Carrello BIO R con rivestimento in rilsan senza sistema ELPAROLL

GR8201/R	1 Base BIO-R 3-4 in rilsan completa di 4 ruote Ø 80 mm (art. 1430) con espansore e paracolpi	
GR8202/R	2 Spalle BIO-R in rilsan	
GR8204/R	1 Reggisacco 70 lt BIO-R in rilsan con clip fermasacco	●
8311	1 Portamanico piccolo	●
GR8206/R	1 Portasacco 70 lt BIO-R in rilsan	
8303/R	1 Portascopa BIO-R	
GR8205/R	2 Portavassoio mini BIO-R in rilsan	
3503	1 Frangia di lavaggio ELPAROLL 45x10 cm	
4020	1 Manico cromato Ø 22 mm, 145 cm con foro (2 pezzi)	
3502	1 Telaio di lavaggio ELPAROLL 45x10 cm	
2250 A	1 Secchio 6 lt	●
2250 R	1 Secchio 6 lt	●
2235 A	1 Secchio 12 lt	●
2235 R	1 Secchio 12 lt	●
2024 A	2 Vassoi mini	●
2024 R	1 Vassoio mini	●
3501 VDM	1 Strizzatore a rullo ELPAROLL	
GR8207/R	1 Portapressa 2x12 lt BIO-R in rilsan	
KITBIOR/A	1 Kit montaggio BIO-R con 1 portamanico (art. KIT5018)	

 100x40x103h cm	 1 Pz/cartone	23,4 Kg	0,190 m ³
	 1 Pz/cartone	19,4 Kg	0,190 m ³











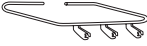
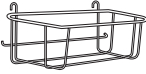
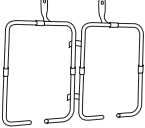

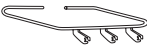
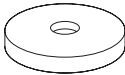

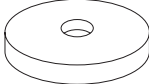
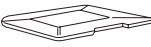

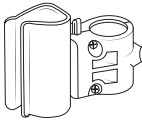
Codice	Descrizione	Colore
--------	-------------	--------

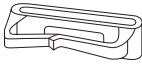
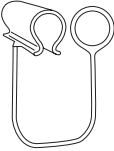
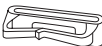
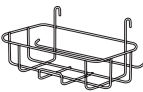
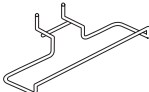

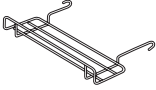
BIO-R 4 Carrello BIO R con rivestimento in rilsan

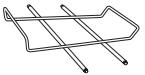
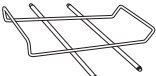
GR8201/R	1 Base BIO-R 3-4 in rilsan completa di 4 ruote Ø 80 mm (art. 1430) con espansore e paracolpi	
GR8202/R	1 Spalla BIO-R in rilsan	
GR8203/R	1 Spalla BIO-R in rilsan completa di maniglia	
GR8204/R	1 Reggisacco 70 lt BIO-R in rilsan con clip fermasacco	
8311	1 Portamanico piccolo	●
8303/R	1 Portascopa BIO-R	
GR8205/R	2 Portavassoio mini BIO-R in rilsan	
2250 A	1 Secchio 6 lt	●
2250 R	1 Secchio 6 lt	●
2024 A	2 Vassoi mini	●
2024 R	1 Vassoio mini	●
KITBIOR/B	1 Kit montaggio BIO-R	

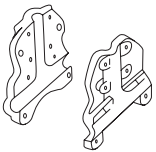
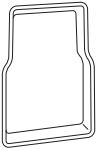
 75x40x103h cm	 1 Pz/cartone	15,5 Kg	0,150 m ³
---	--	---------	----------------------

Codice	Descrizione	Colore	Codice	Descrizione	Colore
 GR8204/R	Reggisacco 70 lt BIO-R in rilsan con clip fermasacco		 7036/R	Cestello portasecchi EUROPE 2 in rilsan	
 GR5027/R	Reggisacco DUO 70 lt BIO-R in rilsan con clip fermasacco		 7045/R	Cestello portaoggetti EUROPE 2 in rilsan	
 GR5013/R	Reggisacco 120 lt BIO-R in rilsan completo di clip fermasacco e attacco coperchio (art. 7031)		 1032	Paracolpi piccolo	●
 5051/B 5051/R	Coperchio per reggisacco DUO (art. GR5027)	● ●	 1036/A	Paracolpi grande	●
 7031 7031 B	Coperchio rettangolare	● ●	 1622	Anello in gomma grande	
 1386	Anello in gomma piccolo		 KIT5018	Kit portamanico completo di aggancio Ø 20 mm	●
 1621	Clip fermasacco	●	 8310	Portamanico grande	●
 1702	Clip fermasacco con anello	●	 8311	Portamanico piccolo	●
 1535/R	Cestello portasecchi in rilsan EUROPE/IDEABASE		 1675	Portascopa multiuso	

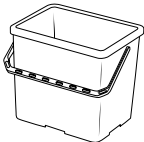
Codice	Descrizione	Colore	Codice	Descrizione	Colore
	8303/R Portascopa BIO-R		2025 A	Vassoio piccolo	●
	GR8206/R Portasacco 70 lt BIO-R in rilsan		2027 A 2027 R	Vassoio medio	● ●
	GR5014/R Portasacco 120 lt BIO-R in rilsan		1030	Ruota Ø 80 mm con filetto 8x28 e parafilo	
	GR8205/R Portavassoio mini BIO-R in rilsan		1030/ZE	Ruota Ø 80 mm con filetto 8x40 e parafilo	
	GR8306/R Portavassoio medio BIO-R 1 in rilsan		1430	Ruota Ø 80 mm con espansore e parafilo	
	1666/R Cestello portaoggetti in rilsan EUROPE/IDEABASE		2030	Ruota Ø 100 mm con filetto 8x28 e parafilo	
	KIT1738 Kit coppia flange plastica per rilsan	●	2034	Ruota Ø 100 mm con espansore e parafilo	
	2023 A Vassoio MINIMAX	●	2075	Ruota morbida Ø 150 mm s/freno con foro passante ed espansore	
	2024 A 2024 R Vassoio mini	● ●	KIT2230	Kit portamanico completo di aggancio Ø 22 mm	●

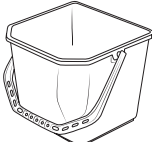
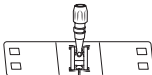
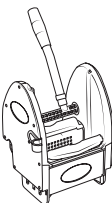
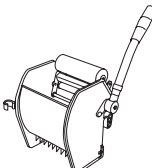
	Codice	Descrizione	Colore
	2250 A 2250 G 2250 R 2250 VS	Secchio 6 lt	● ● ● ●
	2235 A 2235 R	Secchio 12 lt	● ●
	1205 A 1205 R	Secchio 15 lt	● ●
	3502	Telaio di lavaggio ELPAROLL 45x10 cm	
	4100PR	Strizzatore in plastica	●
	3501 VDM	Strizzatore a rullo ELPAROLL	



Multiuso Acciaio Inox

BIOSTEEL

156

Multiuso Acciaio Inox



Ingombri ridotti. La linea Biosteel prevede un sistema brevettato per la riduzione degli ingombri.



Materiale. L'acciaio inox AISI 304 rende questa linea di carrelli estremamente robusta, durevole, adatta ad ogni tipo di esigenza ed ideale per qualsiasi tipologia di applicazione.



Capacità di carico. Dotati di ampi spazi di carico.







Codice	Descrizione	Colore
BIOSTEEL 1	Carrello in acciaio inox BIOSTEEL	
BIOSTEEL 1 S/P	Carrello in acciaio inox BIOSTEEL senza pressa	
GR2700	1 Base BIOSTEEL 1 con 2 ruote Ø 100 mm (art. 2034) con espansore e paracolpi grandi	
GR2702/STD	1 Spalla lunga con 2 coppie piastre e 2 ruote Ø 100 mm (art. 2034) con espansore e paracolpi grandi	
	BIOSTEEL 1-3-5-6-7-8-9	
2735	1 Spalla inox corta	
GR2704	1 Reggisacco inox con anello in gomma	
7031	1 Coperchio rettangolare	●
2705	1 Portasacco inox	●
2025 A	1 Vassoio piccolo	●
2027 A	1 Vassoio medio	●
2027 R	1 Vassoio medio	●
2706	4 Traverse inox lunghe con spondina	●
2250 A	1 Secchio 6 lt	●
2250 G	1 Secchio 6 lt	●
2250 R	1 Secchio 6 lt	●
2250 VS	1 Secchio 6 lt	●
1205 A	1 Secchio 15 lt	●
1205 R	1 Secchio 15 lt	●
2708	1 Portapressa BIOSTEEL	●
4100PA	1 Strizzatore in plastica	●
8311	2 Portamanico piccoli	●
KITBIOSTEEL/A	1 Kit montaggio BIOSTEEL 1 con 1 portamanico (art. KIT2230)	

Codice	Descrizione	Colore
BIOSTEEL 2	Carrello in acciaio inox BIOSTEEL	
GR2711	1 Base BIOSTEEL 2-3-4 con 2 ruote Ø 100 mm (art. 2034) con espansore e paracolpi grandi	
GR2702/100	1 Spalla lunga con 2 ruote Ø 100 mm (art. 2034) con espansore e paracolpi grandi	
GR2735/STD	1 Spalla corta con piastre di fissaggio BIOSTEEL 2-3-10	
GR2704	1 Reggisacco inox con anello in gomma	
7031	1 Coperchio rettangolare	●
2025 A	2 Vassoi piccoli	●
2025 R	1 Vassoio piccolo	●
2706	2 Traverse inox lunghe con spondina	●
2707	2 Traverse inox lunghe	●
2250 A	1 Secchio 6 lt	●
2250 R	1 Secchio 6 lt	●
8311	2 Portamanico piccoli	●
KITBIOSTEEL/B	1 Kit montaggio BIOSTEEL 2-3	

 125x60x108h cm (90x60x140h cm)	 1 Pz/cartone	25,8 Kg	0,250 m ³
	 1 Pz/cartone	23,5 Kg	0,250 m ³

 90x60x108h cm	 1 Pz/cartone	17,5 Kg	0,250 m ³
---	--	---------	----------------------



Codice	Descrizione	Colore
--------	-------------	--------

BIOSTEEL 3 Carrello in acciaio inox BIOSTEEL

GR2711	1 Base BIOSTEEL 2-3-4 con 2 ruote Ø 100 mm (art. 2034) con espansore e paracolpi grandi	
GR2702/STD	1 Spalla lunga con 2 coppie piastre e 2 ruote Ø 100 mm (art. 2034) con espansore e paracolpi grandi BIOSTEEL 1-3-5-6-7-8-9	
GR2735/STD	1 Spalla corta con piastre di fissaggio BIOSTEEL 2-3-10	
GR2704	1 Reggisacco inox con anello in gomma	
7031	1 Coperchio rettangolare	●
2025 A	2 Vassoi piccoli	●
2025 R	1 Vassoio piccolo	●
2706	2 Traverse inox lunghe con spondina	
2707	2 Traverse inox lunghe	
2250 A	1 Secchio 6 lt	●
2250 R	1 Secchio 6 lt	●
2270 A	2 Secchi rett. 13 lt	●
2733	2 Portasecchi 13 lt inox	●
8311	2 Portamanico piccoli	●
KITBIOSTEEL/B	1 Kit montaggio BIOSTEEL 2-3	

Codice	Descrizione	Colore
--------	-------------	--------

BIOSTEEL 5 Carrello in acciaio inox BIOSTEEL

GR2714	1 Base BIOSTEEL 5 con 2 ruote Ø 100 mm (art. 2034) con espansore e paracolpi grandi	
GR2702/STD	1 Spalla lunga con 2 coppie piastre e 2 ruote Ø 100 mm (art. 2034) con espansore e paracolpi grandi BIOSTEEL 1-3-5-6-7-8-9	
2735	1 Spalla inox corta	
GR2704	1 Reggisacco inox con anello in gomma	
7031	1 Coperchio rettangolare	●
2705	1 Portasacco inox	
2025 A	1 Vassoio piccolo	●
2027 A	1 Vassoio medio	●
2027 R	1 Vassoio medio	●
2706	4 Traverse inox lunghe con spondina	
2250 A	1 Secchio 6 lt	●
2250 G	1 Secchio 6 lt	●
2250 R	1 Secchio 6 lt	●
2250 VS	1 Secchio 6 lt	●
5029/PL	1 Cestello forato in plastica per vascone (art.5028)	
5028	1 Vascone in plastica 35 lt	
8311	2 Portamanico piccoli	●
KITBIOSTEEL/D	1 Kit montaggio BIOSTEEL 5 con 1 portamanico (art. KIT2230)	



120x60x108h cm
(90x60x140h cm) | 1 Pz/cartone | 21,8 Kg | 0,250 m³



125x60x108h cm
(90x60x140h cm) | 1 Pz/cartone | 24,2 Kg | 0,250 m³



Codice	Descrizione	Colore
BIOSTEEL 6	Carrello in acciaio inox BIOSTEEL	
BIOSTEEL 6 S/P	Carrello in acciaio inox BIOSTEEL senza pressa	
GR2712/N	1 Base BIOSTEEL 6 con 2 ruote Ø 100 mm (art. 2034) con espansore e paracolpi grandi	
GR2702/STD	1 Spalla lunga con 2 coppie piastre e 2 ruote Ø 100 mm (art. 2034) con espansore e paracolpi grandi BIOSTEEL 1-3-5-6-7-8-9	
2735	1 Spalla inox corta	
GR2704	1 Reggisacco inox con anello in gomma	●
7031	1 Coperchio rettangolare	●
2705	1 Portasacco inox	●
2025 A	1 Vassoio piccolo	●
2027 A	1 Vassoio medio	●
2027 R	1 Vassoio medio	●
2706	4 Traverse inox lunghe con spondina	
2250 A	1 Secchio 6 lt	●
2250 G	1 Secchio 6 lt	●
2250 R	1 Secchio 6 lt	●
2250 VS	1 Secchio 6 lt	●
7030 R	1 Secchio rett. 22 lt	●
2736	1 Portapressa inox (per art. 7001)	
7001	1 Strizzatore in acciaio inox	
8311	2 Portamanico piccoli	●
KITBIOSTEEL/E	1 Kit montaggio BIOSTEEL 6-7 con 1 portamanico (art. KIT2230)	

Codice	Descrizione	Colore
BIOSTEEL 7	Carrello in acciaio inox BIOSTEEL	
BIOSTEEL 7 S/P	Carrello in acciaio inox BIOSTEEL senza pressa	
GR2712	1 Base BIOSTEEL 7 con 2 ruote Ø 100 mm (art. 2034) con espansore e paracolpi grandi	
GR2702/STD	1 Spalla lunga con 2 coppie piastre e 2 ruote Ø 100 mm (art. 2034) con espansore e paracolpi grandi BIOSTEEL 1-3-5-6-7-8-9	
2735	1 Spalla inox corta	
GR2704	1 Reggisacco inox con anello in gomma	●
7031	1 Coperchio rettangolare	●
2705	1 Portasacco inox	●
2025 A	1 Vassoio piccolo	●
2027 A	1 Vassoio medio	●
2027 R	1 Vassoio medio	●
2706	4 Traverse inox lunghe con spondina	
2250 A	1 Secchio 6 lt	●
2250 G	1 Secchio 6 lt	●
2250 R	1 Secchio 6 lt	●
2250 VS	1 Secchio 6 lt	●
7030 A	1 Secchio rett. 22 lt	●
7030 R	1 Secchio rett. 22 lt	●
2720	1 Portasecchio 22 lt inox	
2736	1 Portapressa inox (per art. 7001)	
7001	1 Strizzatore in acciaio inox	
8311	2 Portamanico piccoli	●
KITBIOSTEEL/E	1 Kit montaggio BIOSTEEL 6-7 con 1 portamanico (art. KIT2230)	

 125x60x108h cm (90x60x140h cm)	 1 Pz/cartone	29,4 Kg	0,250 m ³
	 1 Pz/cartone	22,6 Kg	0,250 m ³

 145x60x108h cm (93x60x140h cm)	 1 Pz/cartone	32 Kg	0,250 m ³
	 1 Pz/cartone	25,2 Kg	0,250 m ³



Codice Descrizione Colore

BIOSTEEL 8 Carrello in acciaio inox BIOSTEEL

BIOSTEEL 8 S/P Carrello in acciaio inox BIOSTEEL senza pressa

GR2715	1 Base BIOSTEEL 8 con 2 ruote Ø 100 mm (art. 2034) con espansore e paracolpi grandi	
GR2702/STD	1 Spalla lunga con 2 coppie piastre e 2 ruote Ø 100 mm (art. 2034) con espansore e paracolpi grandi BIOSTEEL 1-3-5-6-7-8-9	
2735	1 Spalla inox corta	
GR2704	1 Reggisacco inox con anello in gomma	
7031	1 Coperchio rettangolare	●
2022 A	1 Vassoio stretto	●
2022 R	1 Vassoio stretto	●
2024 A	1 Vassoio mini	●
2719	4 Traverse inox corte con spondina	
2250 A	1 Secchio 6 lt	●
2250 R	1 Secchio 6 lt	●
1205 A	1 Secchio 15 lt	●
1205 R	1 Secchio 15 lt	●
2705	1 Portasacco inox	
2708	1 Portapressa BIOSTEEL	
4100PA	1 Strizzatore in plastica	●
KITBIOSTEEL/G	1 Kit montaggio BIOSTEEL 8-9 con 5 portamanico (1x art. KIT2230 + 4x art. 2255)	

Codice Descrizione Colore

BIOSTEEL 9 Carrello in acciaio inox BIOSTEEL

BIOSTEEL 9 S/P Carrello in acciaio inox BIOSTEEL senza pressa

GR2717	1 Base BIOSTEEL 9 con 2 ruote Ø 100 mm (art. 2034) con espansore e paracolpi grandi	
GR2702/STD	1 Spalla lunga con 2 coppie piastre e 2 ruote Ø 100 mm (art. 2034) con espansore e paracolpi grandi BIOSTEEL 1-3-5-6-7-8-9	
2735	1 Spalla inox corta	
GR2704	1 Reggisacco inox con anello in gomma	
7031	1 Coperchio rettangolare	●
2705	1 Portasacco inox	
2022 A	1 Vassoio stretto	●
2022 R	1 Vassoio stretto	●
2024 A	1 Vassoio mini	●
2719	4 Traverse inox corte con spondina	
2235 A	1 Secchio 12 lt	●
2235 R	1 Secchio 12 lt	●
2250 A	1 Secchio 6 lt	●
2250 R	1 Secchio 6 lt	●
2708	1 Portapressa BIOSTEEL	
4100PA	1 Strizzatore in plastica	●
KITBIOSTEEL/G	1 Kit montaggio BIOSTEEL 8-9 con 5 portamanico (1x art. KIT2230 + 4x art. 2255)	

100x60x108h cm (70x60x140h cm)	1 Pz/cartone	24 Kg	0,250 m ³
	1 Pz/cartone	21,6 Kg	0,250 m ³

100x45x108h cm (70x45x140h cm)	1 Pz/cartone	22,4 Kg	0,250 m ³
	1 Pz/cartone	20 Kg	0,250 m ³



Codice	Descrizione	Colore
BIOSTEEL 10	Carrello in acciaio inox BIOSTEEL	
GR2718	1 Base BIOSTEEL 10 con 2 ruote Ø 80 mm (art. 1430) con espansore e paracolpi	
GR2702/80	1 Spalla lunga con 2 ruote Ø 80 mm (art. 1430) con espansore e paracolpi	
GR2735/STD	1 Spalla corta con piastre di fissaggio BIOSTEEL 2-3-10	
GR2704	1 Reggisacco inox con anello in gomma	
7031	1 Coperchio rettangolare	●
2022 A	1 Vassoio stretto	●
2022 R	1 Vassoio stretto	●
2024 A	1 Vassoio mini	●
2719	4 Traverse inox corte con spondina	
2250 A	1 Secchio 6 lt	●
2250 R	1 Secchio 6 lt	●
KITBIOSTEEL/H	1 Kit montaggio BIOSTEEL 10 con 2 portamanico (art. 2255)	●

Codice	Descrizione	Colore
BIOSTEEL 11	Carrello in acciaio inox BIOSTEEL	
GR2760	1 Struttura inox piccola completa di 4 ruote Ø 125 mm (art. 2050) con paracolpi e 4 coppie piastre alluminio	
GR2759	1 Maniglia di spinta inox corta	
GR2704	1 Reggisacco inox con anello in gomma	
2710	1 Cursore compl. per reggisacco rett. (con 2 clip art. 1701)	● ●
7031 B	1 Coperchio EF/HO	●
2022 R	1 Vassoio stretto	●
2025 A	1 Vassoio piccolo	●
2027 A	1 Vassoio medio	●
2752	1 Portavassoio inox	
2250 A	1 Secchio 6 lt	●
2250 R	1 Secchio 6 lt	●
7030 R	1 Secchio rett. 22 lt	●
2720	1 Portasecchio 22 lt inox	
2028	2 Contenitori scorrevoli per BIOSTEEL 11-12	
8311	1 Portamanico piccolo	●
KITBIOSTEEL/I	1 Kit montaggio BIOSTEEL 11-12 con 2 portamanico in gomma (art. 2255)	

Produzione su richiesta (minimo 20 pz)

70x45x106h cm



1 Pz/cartone

15 Kg

0,150 m³

120x60x120h cm



1 Pz/cartone

26 Kg

0,430 m³



Codice	Descrizione	Colore
--------	-------------	--------

BIOSTEEL 12 Carrello in acciaio inox BIOSTEEL

GR2760	1 Struttura inox piccola completa di 4 ruote Ø 125 mm (art. 2050) con paracolpi e 4 coppie piastre alluminio	
GR2759	1 Maniglia di spinta inox corta	
GR2770	1 Reggisacco inox doppio con anelli in gomma	
2710	1 Cursore compl. per reggisacco rett. (con 2 clip art. 1701)	● ●
7031 B	1 Coperchio EF/HO	●
7031	1 Coperchio EF/HO	●
2022 R	1 Vassoio stretto	●
2025 A	1 Vassoio piccolo	●
2027 A	1 Vassoio medio	●
2752	1 Portavassoio inox	
2250 A	1 Secchio 6 lt	●
2250 R	1 Secchio 6 lt	●
7030 R	1 Secchio rett. 22 lt	●
2720	1 Portasecchio 22 lt inox	
2028	2 Contenitori scorrevoli per BIOSTEEL 11-12	
8311	1 Portamanico piccolo	●
KITBIOSTEEL/I	1 Kit montaggio BIOSTEEL 11-12 con 2 portamanico in gomma (art. 2255)	

Produzione su richiesta (minimo 20 pz)











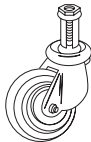

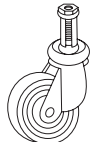

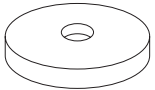
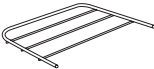

Codice	Descrizione	Colore
--------	-------------	--------

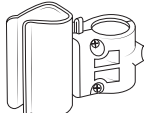

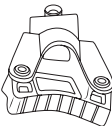

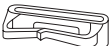







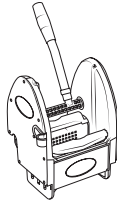

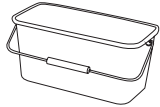
BIOSTEEL X Carrello in acciaio inox BIOSTEEL X

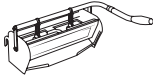
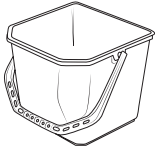
GRBIOSTEELX	1 Struttura inox carrello BIOSTEEL X con 4 ruote Ø 80 mm (art. 1430) e paracolpi	
1680/G	1 Sacco in cotone sanforizzato 230 lt	

 135x60x124h cm |  1 Pz/cartone 30 Kg 0,430 m³

 53x50x104h cm |  2 Pz/cartone 15 Kg 0,175 m³

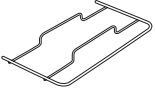
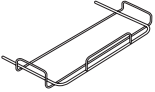
	Codice	Descrizione	Colore		Codice	Descrizione	Colore
	GR2704	Reggisacco inox con anello in gomma			1430	Ruota Ø 80 mm con espansore e parafilo	
	2770	Reggisacco DUO 120 lt in inox senza coperchi			2034	Ruota Ø 100 mm con espansore e parafilo	
	1622	Anello in gomma grande			1032	Paracolpi piccolo	●
	7031	Coperchio rettangolare	●		1036/A	Paracolpi grande	●
	2705	Portasacco inox			2022 A 2022 R	Vassoio stretto	● ●
	KIT2230	Kit portamanico completo di aggancio Ø 22 mm	●		2024 A	Vassoio mini	●
	2255	Portamanico in gomma con aggancio Ø 22 mm			2025 A 2025 R	Vassoio piccolo	● ●
	8311	Portamanico piccolo	●		2027 A 2027 R	Vassoio medio	● ●
	1680/G	Sacco in cotone sanforizzato 230 lt			2250 A 2250 G 2250 R 2250 VS	Secchio 6 lt	● ● ● ●

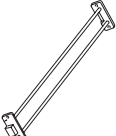
Codice	Descrizione	Colore	Codice	Descrizione	Colore
 2235 A 2235 R	Secchio 12 lt	 	 4100PA	Strizzatore in plastica	
 2270 A	Secchio rett. 13 lt		 7001	Strizzatore in acciaio inox	
 1205 A 1205 R	Secchio 15 lt	 			
 7030 A 7030 R	Secchio rett. 22 lt	 			
 KIT2701	Kit coppia piastre alluminio per BIOSTEEL				
 2733	Portasecchio 13 lt inox				
 2720	Portasecchio 22 lt inox				
 2723	Cestello portaflaconi				
 2736	Portapressa inox (per art. 7001)				



Strizzatori



Strizzatori



Semplicità e resistenza. Strizzatore in plastica per mop, con alberino in lega di alluminio e gancio per manico.



Innovazione. Strizzatore a rullo ELPAROLL in polipropilene copolimero rinforzato, meccanismi in acciaio inox AISI 304, rulli elastici in poliuretano. Possibilità di sciacquare la frangia passando direttamente dall'interno dello strizzatore.







Tradizione. Strizzatore in acciaio inox.





Forza. Strizzatore in plastica con cestello in acciaio zincato, completo di riduttore.



Microroll. Strizzatore a rulli MICROROLL per panni in microfibra e panni in genere. Applicabile al secchio da 6 lt, al secchio COMFORT S/S da 15 lt e al secchio da 22 lt.

	Codice	Descrizione	Conf.	Volume/Peso Conf. m ³ /kg
	Plastica			
	4100PB ● 4100PR ●	Strizzatore in plastica per mop, con alberino in lega di alluminio, completo di gancio per manico	6	0,185/15,8
	3070 P	Riduttore per strizzatore 4100P	200	0,185/22
	4300 P	Strizzatore in plastica maxi per mop fino a 600 g, completo di riduttore	6	0,185/20
	Plastica Acciaio Zincato			
	3000 Z	Strizzatore in plastica con cestello in acciaio zincato, completo di riduttore	6	0,185/27
	Plastica/Acciaio INOX (AISI 304)			
	3501 VDM	Strizzatore a rullo ELPAROLL in polipropilene copolimero rinforzato, dotato di meccanismi in acciaio inox AISI 304 e rulli elastici in poliuretano	6	0,155/22
	Plastica			
	4601	Strizzatore a rullo in plastica semi professionale	6	0,155/16

Codice	Descrizione	Conf.	Volume/Peso Conf. m ³ /kg
Plastica/Acciaio INOX (AISI 304)			
	4550 Strizzatore a rulli MICROROLL per panni in microfibra e panni in genere. Applicabile al secchio da 6 lt (art. 2250) e al secchio COMFORT S/S da 15 lt	10	0,100/16
	4575 Strizzatore a rulli MICROROLL per panni in microfibra e panni in genere. Applicabile al secchio da 22 lt (art. 7030)	10	0,100/17
Acciaio INOX (AISI 304)			
	7001 Strizzatore in acciaio inox	3	0,150/22



Secchi e Componenti in Plastica

Secchi e Componenti in Plastica



Innovazione VDM. Dosatore Tecno-Shower in polipropilene copolimero che permette di pre-impregnare perfettamente ed in modo omogeneo le frange di lavaggio. Fondo inclinato per una maggiore efficacia nella distribuzione della soluzione.







Tecno-Shower. Fori con conformazione e diametri differenti, alette centrali in rilievo per una più semplice distribuzione a "pioggia" della soluzione. Ganci di posizionamento al bordo del secchio (capacità secchio 22 lt) e ganci per appendere il dosatore alla parte frontale del secchio.













Touch Free System. Sistema di pulizia professionale (patent pending) applicabile ai carrelli che prevedono la pre-impregnazione. È composto da: 1 telaio per frangia di lavaggio a tasche, 2 alette da inserire sul secchio da 22 Lt (adibito a raccolta delle frange esauste) atte a sganciare la frangia dal telaio di lavaggio senza toccare mai con le mani né il telaio né la frangia sporca.













Vantaggi. Con il nuovo Touch Free System le frange di lavaggio vengono sganciate direttamente nel secchio di recupero, in modo facile ed ergonomico, senza l'utilizzo delle mani: così facendo si evita il rilascio di sporco sul pavimento, l'inalazione di batteri, germi o sporco da parte dell'operatore, il contatto dell'operatore con le frange e/o il telaio, e si ha una sensibile riduzione della contaminazione incrociata.





	Codice	Descrizione	Conf.	Volume/Peso Conf. m ³ /kg
	23020 B ● 23020 G ● 23020 R ● 23020 VS ●	Secchio - 4 lt 24x17/9x22h cm		
	2250 A ● 2250 B ● 2250 R ● 2250 G ● 2250 VS ●	Secchio - 6 lt 26x19x22h cm	50	0,185/26
	2252 ●	Coperchio per secchio 6 lt		
	2253 ●	Separatore flaconi per secchio 6 lt		
	23021 ●	Coperchio per secchio 4 lt		









	Codice	Descrizione	Conf.	Volume/Peso Conf. m ³ /kg
	4635 ● 4635/R ●	Secchio - 8 Lt 30x19/13x25h cm	20	0,120/10
	2235 A ● 2235 R ●	Secchio - 12 Lt 31x24,5x26h cm	20	0,120/14,5
	1205 A ● 1205 R ●	Secchio - 15 Lt 34x34x27,5h cm	12	0,145/13,5
	21005 B ● 21005 R ●	Secchio IDEA - 15 Lt 31,5x32/20x33h cm	10	0,145/20
	1005 A ● 1005 R ●	Secchio - 25 Lt 34x35,5x32h cm	10	0,165/14





	Codice	Descrizione	Conf.	Volume/Peso Conf. m ³ /kg
	2270 A ● 2270 R ●	Secchio rett. - 13 lt 47x22x21h cm	25	0,150/23,5
	7030 A ● 7030 R ● 7030 B ●	Secchio rett. - 22 lt 54x27x27h cm	6	0,120/8,7
	7038 ●	Coperchio per secchio rett. 22 lt	10	0,047/4,25
	1085 A ●	Secchio a due vasche con strizzino	5	0,076/7,1
	COMFORT A ● COMFORT G ● COMFORT R ● COMFORT V ●	Secchio COMFORT con strizzino - 15 lt	10	0,060/9,1
	COMFORT S/S	Secchio COMFORT senza strizzino - 15 lt		0,060/8

	Codice	Descrizione	Conf.	Volume/Peso Conf. m ³ /kg
	GIPSY A/G ● ●	Set multiuso GIPSY completo di: 5 separatori e 4 portamanico	2	0,100/8
	2306 ●	Secchiello vetri per GIPSY 47x12x30h cm		
	2310	Tracolla per GIPSY		
	7080 ●	Dosatore Tecno-Shower		
	2024 A ● 2024 R ●	Vassoio mini 40x26x8h cm		

Codice	Descrizione	Conf.	Volume/Peso Conf. m ³ /kg
 2025 A ● 2025 R ●	Vassoio piccolo 45x40x8h cm		
 2027 A ● 2027 R ●	Vassoio medio 50x40x8h cm		
 2026 A ● 2026 R ●	Vassoio grande 63x40x8h cm		
 2022 A ● 2022 R ●	Vassoio stretto 50x20x8h cm		
 2023 A ●	Vassoio MINIMAX 32/38x54x8h cm		

	Codice	Descrizione	Conf.	Volume/Peso Conf. m ³ /kg
	21010 B ● 21010 R ●	Vassoio IDEA 45x26x9h cm		
	21070 B ● 21070 R ●	Vassoio maxi IDEA con 4 portamanico integrati 61x39x9h cm		
	23015 GR ○	Vassoio MX 42x28x8,5h cm		
	24051 ● 24051 GT ○	Cestello portasecchi IDEA 53x20x12h cm		
	24053 ● 24053 GT ○	Cestello portaoggetti IDEA 52x14x12h cm		

Codice	Descrizione	Conf.	Volume/Peso Conf. m ³ /kg
 2710	 Cursore compl. per reggisacco rett. (con 2 clip art. 1701)		
 8310	 Portamanico grande		
 8311 8311/R	 Portamanico piccolo		
 2255	 Portamanico in gomma con aggancio Ø 22 mm		
 5065	 Portamanico in gomma con aggancio Ø 20 mm		

	Codice	Descrizione	Conf.	Volume/Peso Conf. m ³ /kg
	4022	Innesto con filetto per manico Ø 22 mm Adattabile al manico 4020		
	4024	Innesto con filetto per manico Ø 24 mm Adattabile ai manici 4025 e 4421		
	KIT5018/G ●	Gancio con aggancio Ø 20 mm		
	KIT2231 ●	Gancio con aggancio Ø 22 mm		
	KIT2234 ●	Gancio con aggancio Ø 24 mm		
	KIT2230 ●	Kit portamanico completo di aggancio Ø 22 mm		
	KIT5018 ●	Kit portamanico completo di aggancio Ø 20 mm		
	1701 ●	Clip fermasacco con anello		
	1702 ●			



Contenitori in Plastica

Contenitori in plastica



Versatili ed ergonomici. Sono disponibili in diverse capacità (90 lt, 70 lt, 45 lt, 40 lt, 30 lt, 20 lt, 12 lt, 6 lt, 3 lt) e sono tutti dotati di apertura del coperchio con pedale.



Colorati. Possono essere accessoriati con coperchi di differenti colori per una raccolta differenziata adatta ad ogni esigenza.





	Codice	Descrizione	Conf.	Volume/Peso Conf. m ³ /kg
	25001 BI ○ 25001 B ● 25001 R ● 25001 V ● 25001 GI ●	Contenitore FORMULA in plastica bianco - 90 lt coperchio* con apertura a pedale (possibilità di scelta colore coperchio)	3	0,211/16
* coperchio non vendibile separatamente dal contenitore				
	25002 BI ○ 25002 B ● 25002 R ● 25002 V ● 25002 GI ●	Contenitore FORMULA in plastica bianco - 70 lt coperchio* con apertura a pedale (possibilità di scelta colore coperchio)	3	0,168/14
* coperchio non vendibile separatamente dal contenitore				
	25003 BI ○ 25003 B ● 25003 R ● 25003 V ● 25003 GI ●	Contenitore FORMULA in plastica bianco - 45 lt coperchio* con apertura a pedale (possibilità di scelta colore coperchio)	3	0,138/9,5
* coperchio non vendibile separatamente dal contenitore				
	25004 BI ○ 25004 B ● 25004 R ● 25004 V ● 25004 GI ●	Contenitore FORMULA in plastica bianco - 30 lt coperchio* con apertura a pedale (possibilità di scelta colore coperchio)	4	0,136/10,2
* coperchio non vendibile separatamente dal contenitore				
	25011 25012 25013 25014 25015	Contenitore TOP in plastica con apertura a pedale - 3 lt Contenitore TOP in plastica con apertura a pedale - 6 lt Contenitore TOP in plastica con apertura a pedale - 12 lt Contenitore TOP in plastica con apertura a pedale - 20 lt Contenitore TOP in plastica con apertura a pedale - 40 lt	12 6 6 2 1	0,088/5 0,088/5 0,154/7 0,100/4,1 0,132/3,5





Telai e Frange di Scopatura

Telai e Frange di Scopatura

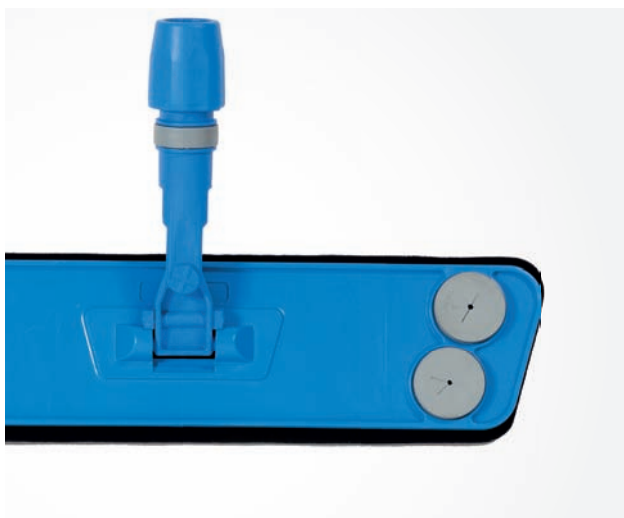

Telaio di scopatura con fondo in spugna per panni monouso.

Telaio in plastica per panni monouso disponibile in varie dimensioni. Provvisto di quattro inserti a stella per il fissaggio del panno. Disponibile spugna di ricambio.

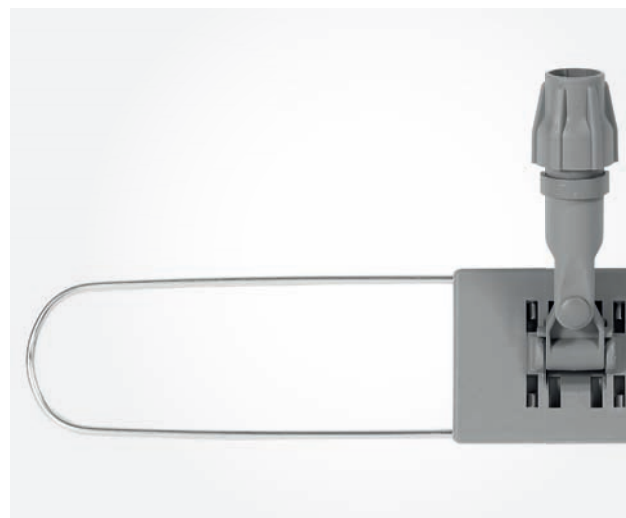

Telaio pieghevole per frange di scopatura. Telaio pieghevole per agevolare l'inserimento della frangia di scopatura. Disponibile in varie dimensioni.



Telaio per scopa a forbice. Telaio con staffe in legno o metallo per scopa a forbice.

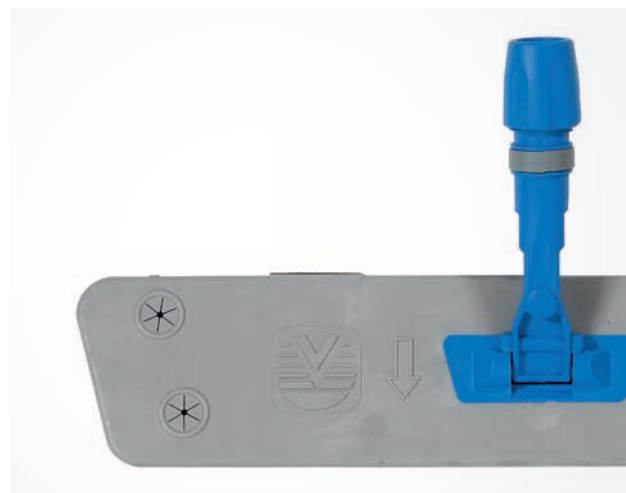

Telaio di scopatura con fondo lamellare per panni monouso.

Telaio in schiuma poliuretanicca per panni impregnati o carichi elettrostaticamente. Autoclavabile a 120°.



Semplice. Dotato di quattro inserti a stella e di due inserti in velcro per il fissaggio veloce del panno.

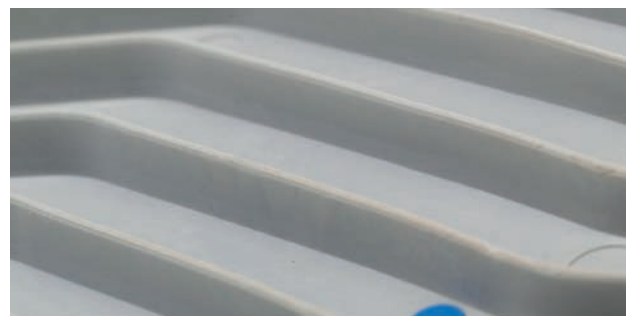

Stabilità, flessibilità e aderenza. Fondo lamellare per ottenere la massima adesione al pavimento. Si adatta perfettamente alla conformazione di qualsiasi pavimento conservando inalterata nel tempo questa sua caratteristica.



Materiale: COTONE

Vantaggi: garantisce un alto assorbimento dello sporco.

Campo d'impiego: ideale per la pulizia di grandi superfici (palestre, centri commerciali, aeroporti) e con presenza di sporco grossolano.



Non usare ammorbidente



Materiale: ACRILICO

Vantaggi: alta carica elettrostatica.

Campo d'impiego: ideale per la pulizia di grandi superfici (palestre, centri commerciali, aeroporti) e con presenza di sporco grossolano.



Non usare ammorbidente

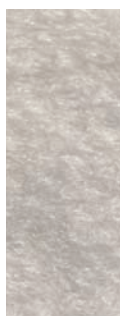

PANNI IMPREGNATI

Materiale: 100% polipropilene (impregnazione 20%).

Vantaggi:

- riduzione carica batterica;
- non solleva polvere;
- non rovina la cera;
- velocità nell'eseguire l'operazione;
- poca fatica per l'Operatore.

Campo d'impiego: ideali per la pulizia di ambienti sanitari, per pulizie di precisione e con presenza di sporco medio.

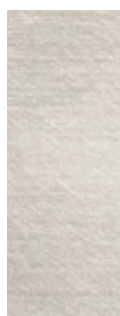





PANNI ELETTROSTATICI





Materiale: 100% poliestere.





Vantaggi:









- riduzione carica batterica;
- non solleva polvere;
- non rovina la cera;
- velocità nell'eseguire l'operazione;
- poca fatica per l'Operatore.



Campo d'impiego: ideali per la pulizia di ambienti sanitari, per pulizie di precisione e con presenza di sporco medio.

	Codice	Descrizione	Conf.	Volume/Peso Conf. m ³ /kg
	4087	Telaio in gomma lamellare per panni monouso (60 cm) provvisto di: 2 inserti in velcro e 4 inserti a stella per il fissaggio del panno	25	0,150/24
	4085/N 4086/N	Telaio per panni monouso con spugna - 40 cm Telaio per panni monouso con spugna - 50 cm	25	0,065/8,5 0,080/9,8
	4085/SPN 4086/SPN	Spugna di ricambio - 40 cm Spugna di ricambio - 50 cm	25	
	4086	Telaio per panni monouso con spugna - 60 cm	25	0,065/6,3
	4086/SPU	Spugna di ricambio - 60 cm	25	

	Codice	Descrizione	Conf.	Volume/Peso Conf. m ³ /kg
	4181 4182 4183 4184	Panno impregnato monouso - 60x17 cm Panno impregnato monouso - 60x20 cm Panno impregnato monouso - 60x30 cm Panno impregnato monouso - 60x22 cm	20x50	0,030/2,8 0,030/3,2 0,045/5,4 0,030/3,5
	6020 6030	Panno elettrostatico bianco - 60x20 cm Panno elettrostatico bianco - 60x30 cm (100% poliestere)	20x50	0,095/9,7 0,125/13
	6041 60642 6042 6043 60641	Garza in cotone con foro centrale per scopatura - 60x80 cm Garza in cotone con foro centrale per scopatura - 90x80 cm Garza in cotone con foro centrale per scopatura - 100x80 cm Garza in cotone con foro centrale per scopatura - 120x80 cm Garza in cotone con foro centrale per scopatura - 140x80 cm	200	0,036/6 0,046/9 0,071/10,3 0,067/11 0,071/12,6
	4041 4042 4043 4044	Telaio pieghevole - 40 cm Telaio pieghevole - 60 cm Telaio pieghevole - 80 cm Telaio pieghevole - 100 cm	25	0,034/6,7 0,050/8,3 0,062/11,2 0,080/21,3
	4041/N 4042/N 4043/N	Telaio pieghevole - 40 cm Telaio pieghevole - 60 cm Telaio pieghevole - 80 cm	25	0,036/7,5 0,055/10,6 0,072/15,2

	Codice	Descrizione	Conf.	Volume/Peso Conf. m ³ /kg
	4041/M	Telaio pieghevole in metallo - 40 cm	25	0,033/9,5
	4042/M	Telaio pieghevole in metallo - 60 cm		0,049/12
	4043/M	Telaio pieghevole in metallo - 80 cm		0,064/15,2
	4045	Telaio fisso in metallo - 110 cm	10	0,022/16,2
	4046	Telaio fisso in metallo - 130 cm		0,022/16,8
	4047	Telaio fisso in metallo - 160 cm		0,030/18,7
	4071	Scopa a forbice completa (2 mt), con staffe in legno	10	0,32/50
	4071/M	Scopa a forbice completa (2 mt), con staffe in metallo		
	4073	Telaio per scopa a forbice con staffe in legno	10	0,124/21,2
	4073/M	Telaio per scopa a forbice con staffe in metallo	10	0,124/21,2
				

	Codice	Descrizione	Conf.	Volume/Peso Conf. m ³ /kg
	4074	Manico per scopa a forbice	5	0,060/9,6
	Cotone (con tasche)			
	4131	Frangia in cotone per polvere con tasche - 40 cm	25	0,025/4
	4132	Frangia in cotone per polvere con tasche - 60 cm		0,034/6,2
	4133	Frangia in cotone per polvere con tasche - 80 cm		0,044/7,8
	4134	Frangia in cotone per polvere con tasche - 100 cm		0,054/9,8
	Sintetico (con tasche)			
	4141	Frangia sintetica per polvere con tasche - 40 cm	25	0,025/3,7
	4142	Frangia sintetica per polvere con tasche - 60 cm		0,034/5,5
	4143	Frangia sintetica per polvere con tasche - 80 cm		0,044/6,8
	4144	Frangia sintetica per polvere con tasche - 100 cm		0,054/8,2
	Cotone (con lacci)			
	4051	Frangia in cotone per polvere con lacci - 40 cm	25	0,025/4
	4052	Frangia in cotone per polvere con lacci - 60 cm	25	0,034/6,2
	4053	Frangia in cotone per polvere con lacci - 80 cm	25	0,044/7,8
	4054	Frangia in cotone per polvere con lacci - 100 cm	25	0,054/9,8
	4055	Frangia in cotone per polvere con lacci - 110 cm	25	0,075/10
	4056	Frangia in cotone per polvere con lacci - 130 cm	25	0,075/11
	4057	Frangia in cotone per polvere con lacci - 160 cm	25	0,075/12
	4072	Ricambio frangia cotone lacci per telaio scopa a forbice (2x1mt)	10	0,075/9,2
	Sintetico (con lacci)			
	4061	Frangia sintetica per polvere con lacci - 40 cm	25	0,025/4,5
	4062	Frangia sintetica per polvere con lacci - 60 cm	25	0,034/6,4
	4063	Frangia sintetica per polvere con lacci - 80 cm	25	0,044/7
	4064	Frangia sintetica per polvere con lacci - 100 cm	25	0,054/9,4
	4065	Frangia sintetica per polvere con lacci - 110 cm	25	0,075/9,6
	4066	Frangia sintetica per polvere con lacci - 130 cm	25	0,075/11
	4067	Frangia sintetica per polvere con lacci - 160 cm	25	0,075/11,9
	4072/S	Ricambio frangia sintetica con lacci per telaio scopa a forbice (2x1mt)	10	0,075/8,5

	Codice	Descrizione	Conf.	Volume/Peso Conf. m ³ /kg
	70310	Frangia in microfibra per polvere rigata con velcro - 60x14 cm	50	
	71210	Frangia in microfibra per polvere bianca con velcro - 60x11 cm	50	





Telai e Frange di Lavaggio

Telai e Frange di Lavaggio



Materiale: COTONE

Vantaggi: buona capacità pulente ed assorbente.

Campo d'impiego: indicato per la pulizia quotidiana di superfici da poco sporche a mediamente sporche.



Non usare ammorbidente



Materiale: SINTETICO, mix di poliestere e viscosa

Vantaggi: alte performance di pulizia, alto potere assorbente, lento rilascio della soluzione pulente, capacità di trattenere lo sporco.

Campo d'impiego: indicato per la pulizia quotidiana di superfici mediamente sporche.



Non usare ammorbidente

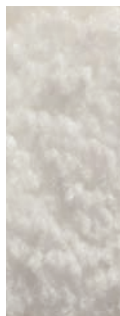

Bianca pelo raso

Materiale: MICROFIBRA 100% poliestere

Campo d'impiego: l'elevata capacità di rimozione dello sporco ne fa una frangia ideale per la pulizia di manutenzione in ambito ospedaliero.

Vantaggi:

- alta scorrevolezza su superfici trattate e non porose;
- cattura lo sporco senza lasciare aloni;
- elevata capacità di rimozione dello sporco;
- ottimizzazione dei cicli di lavaggio.



Non usare ammorbidente

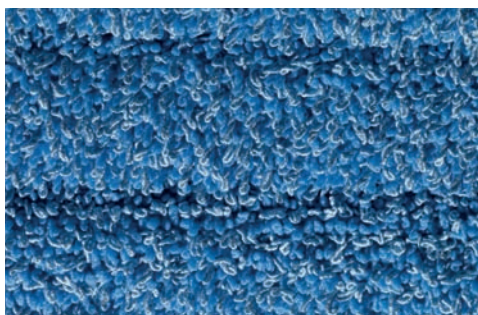

Micro anello

Materiale: 80% poliestere e 20% poliammide

Campo d'impiego: particolarmente efficace ed ideale per la pulizia di superfici lucide (centri commerciali, hall alberghi, etc.) con un grado di sporco medio.

Vantaggi:

- alta scorrevolezza su superfici microporose;
- non lascia aloni;
- elevata resistenza ai lavaggi in lavatrice;
- resa ottimale su piastrelle in gres.



Non usare ammorbidente

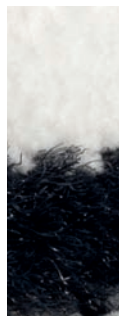

Rigata pelo raso

Materiale: MICROFIBRA

Filato bianco: 100% poliestere

Inserito grigio: 100% poliammide ad alta tenacità

Campo d'impiego: adatta a tutti i tipi di superfici e a tutti i tipi di sporco. L'inserito grigio la rende ideale su sporchi ostinati.

Vantaggi:

- alta scorrevolezza su tutti i tipi di pavimento;
- cattura lo sporco senza lasciare aloni;
- elevata capacità di rimozione dello sporco più difficile;
- ottimizzazione dei cicli di lavaggio;
- grazie agli inserti grigi è possibile rimuovere lo sporco presente nelle fughe;
- ideale anche per la scopatura di pavimenti molto porosi e con presenza di fughe.



Non usare ammorbidente



Anello

Materiale: mix di microfibra (80% poliestere e 20% poliammide) e sintetico (poliestere e viscosa)





Campo d'impiego: indicato su tutti i tipi di pavimento con presenza di fughe e di sporco medio-alto.





Vantaggi:



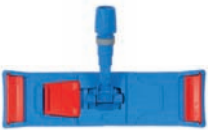

- soddisfa i più elevati standard di pulizia;
- alta scorrevolezza;
- capacità di catturare lo sporco in profondità;
- ideale per superfici porose e con fughe larghe;
- ottima capacità di raccogliere e trattenere impurità come polvere e capelli;
- lento rilascio della soluzione pulente per risultati privi di aloni;
- indicata anche per pavimenti con grado di sporco elevato.

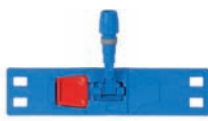











Non usare ammorbidente





	Codice	Descrizione	Conf.	Volume/Peso Conf. m ³ /kg
Attacco Velcro				
	7033	Telaio in plastica TRAPEZE con velcro - 40 cm	25	0,043/6,5
	0480 0481	Refil ricambio velcro corto Refil ricambio velcro lungo		
	34710	Telaio in alluminio TRAPEZE con velcro - 40x10 cm	10	0,014/3,6
	7081	Telaio in acciaio inox TRAPEZE con velcro - 40 cm	25	0,045/13,5
	0480 0481	Refil ricambio velcro corto Refil ricambio velcro lungo		
	4086 SS	Telaio in plastica TRAPEZE con velcro - 60 cm	25	0,065/6
	0478 0479	Refil ricambio velcro corto Refil ricambio velcro lungo		
Attacco Tasche				
	7008	Telaio in acciaio inox pieghevole - 40x10 cm		





	Codice	Descrizione	Conf.	Volume/Peso Conf. m ³ /kg
	4075	Telaio in plastica a pedale - 40x10 cm	25	0,043/11,6
	4083/N	Telaio in plastica a pedale - 40x13 cm	25	0,056/13,7
	4080/N	Telaio in plastica a pedale - 50x13 cm		0,072/15,8
Attacco Alette				
	3710	Telaio CLACK a pedale - 40x11 cm	25	0,057/13,7
Attacco Bottoni				
	3502	Telaio in plastica ELPAROLL - 45x10 cm	25	0,055/11
	3506	Telaio ELPAROLL a pedale - 45x10 cm	25	0,057/13,7
TOUCH FREE SYSTEM				
	7026	Telaio TOUCH FREE SYSTEM - 40x11 cm	1	

Codice	Descrizione	Conf.	Volume/Peso Conf. m ³ /kg
	KIT7026 Kit TOUCH FREE SYSTEM completo di telaio (art. 7026)	1	
Attacco Velcro			
	70300 Jolly Frangia di lavaggio in microfibra rigata con velcro - 44x13 cm	50	
	7011 Frangia per asciugatura con velcro - 40 cm	50	
	60670 Blue Frangia di lavaggio in microfibra con velcro - 45x14 cm	50	0,037/7,5
	70200 Soft Frangia di lavaggio in microfibra con velcro - 45x15 cm	50	

	Codice	Descrizione	Conf.	Volume/Peso Conf. m ³ /kg
	71200 Soft FR	Frangia di lavaggio in microfibra con velcro - 44x11 cm	50	
	7013	Frangia di lavaggio con velcro - 45x14 cm	10	0,015/1,5
	7039	Frangia di lavaggio in microfibra con velcro - 45x14 cm	10	0,015/1,5
	Monouso			
	60540	Frangia di lavaggio monouso in polipropilene e fibra sintetica 45x10 cm	1 (250pz)	0,035/2,6
	Attacco Alette			
	3720	Frangia di lavaggio con alette per telaio CLACK - 40x11 cm	10	0,015/1,6

	Codice	Descrizione	Conf.	Volume/Peso Conf. m ³ /kg
	3720/MF	Frangia di lavaggio in microfibra con alette per telaio CLACK 40x11 cm	10	0,015/1,6
	Attacco Alette + Occhielli			
	60664	Frangia di lavaggio in microfibra con alette e occhielli - 40 cm	50	0,037/7,5
	Attacco Bottoni			
	3503	Frangia di lavaggio ELPAROLL con bottoni - 45x10 cm	100	0,190/20,2
	3504	Frangia di lavaggio in microfibra ELPAROLL con bottoni - 45x10 cm	100	0,190/20,2
	3505	Frangia di lavaggio ELPAROLL con bottoni - 45x10 cm	100	0,190/20,2

	Codice	Descrizione	Conf.	Volume/Peso Conf. m ³ /kg
	3526	Frangia di lavaggio abrasiva ELPAROLL con bottoni - 45x11 cm	100	0,190/20
Attacco Tasche				
	70302 Jolly	Frangia di lavaggio in microfibra rigata con tasche - 43x14 cm	50	
	4076	Frangia di lavaggio con tasche - 40x11 cm	25	0,029/4,4
	4076 MF	Frangia di lavaggio in microfibra con tasche - 40x11 cm	25	0,029/4,4
	4084 4081	Frangia di lavaggio con tasche - 40x13 cm Frangia di lavaggio con tasche - 50x13 cm	25	0,041/5,5 0,042/6,5

	Codice	Descrizione	Conf.	Volume/Peso Conf. m ³ /kg
	7009	Frangia di lavaggio EF con tasche - 40x10 cm	25	0,029/3,6
	7009 MF	Frangia di lavaggio in microfibra con tasche (per art. 7008) 40x10 cm	25	0,029/3,6
	70402 Soft	Frangia di lavaggio in microfibra bianca con tasche - 43x14 cm	50	
	60663	Frangia di lavaggio in microfibra con tasche - 40 cm	50	0,037/8
	Attacco Tasche + Occhielli			
	60660	Frangia di lavaggio in microfibra con tasche e occhielli - 40 cm	50	0,037/6,9

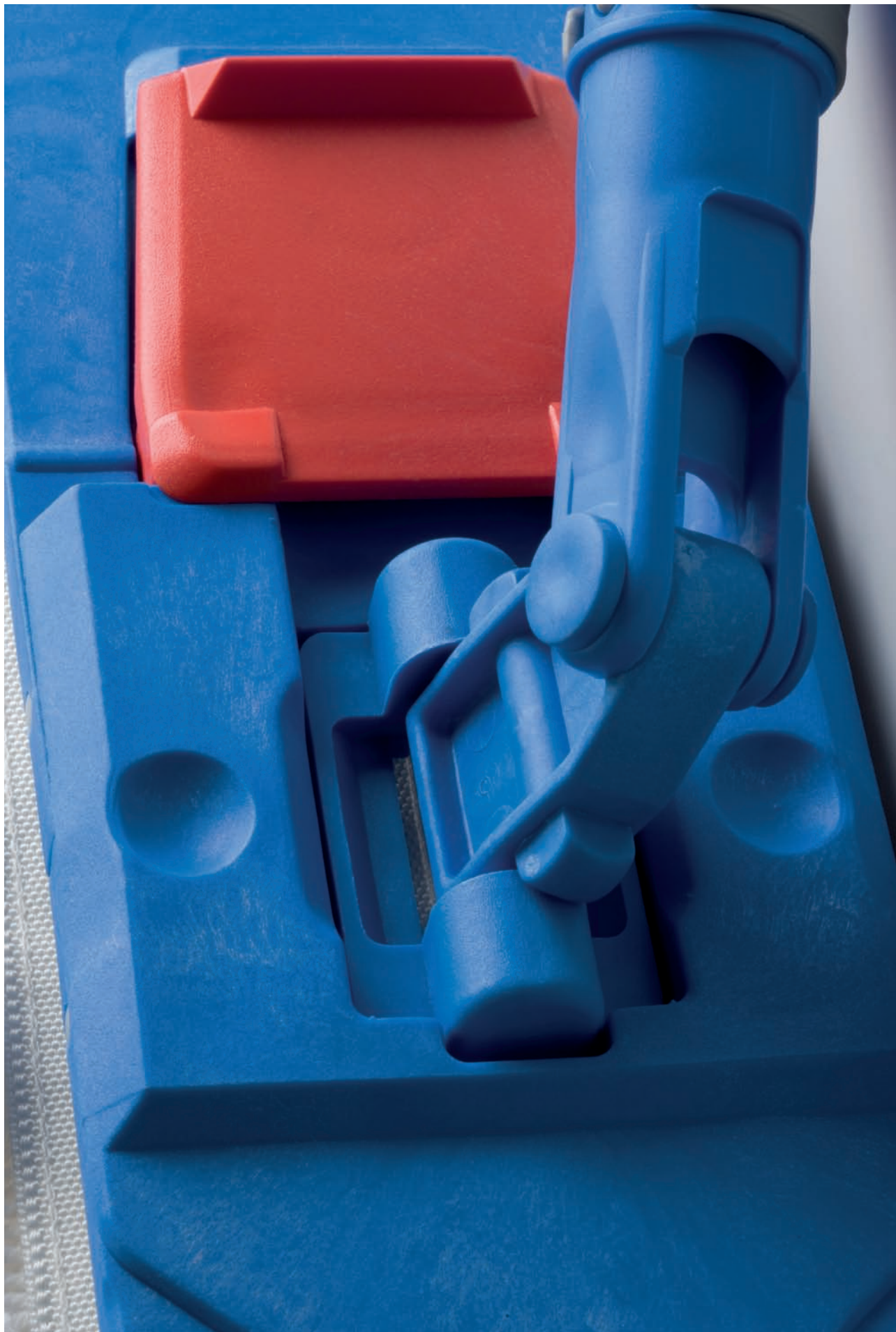

Mop e Pinze



Mop e pinze





Materiale: TNT

Vantaggi: Elevato potere assorbente.

Campo d'impiego: indicato nell'industria alimentare.



Non usare ammorbidente



Materiale: COTONE (Filo fine)

Vantaggi: Grande capacità di trattenere lo sporco.

Campo d'impiego: per la pulizia di tutte le superfici interne.



Non usare ammorbidente



Materiale: COTONE (Filo grosso)

Vantaggi: Grande capacità di trattenere lo sporco.

Campo d'impiego: per la pulizia di tutte le superfici interne.



Non usare ammorbidente

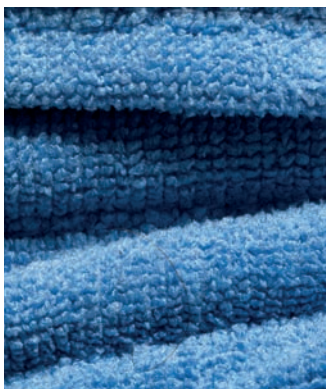





Materiale: MICROFIBRA





Vantaggi: Efficace in presenza di sporco ostinato.



Campo d'impiego: ideale su tutti i tipi di pavimento interni e indicato nell'industria alimentare.



Non usare ammorbidente

	Codice	Descrizione	Conf.	Volume/Peso Conf. m ³ /kg
	COTONE			
	1068/250	Mop cotone filo fine con attacco a vite - 250 g	50	0,072/14,5
	1068/280	Mop cotone filo fine con attacco a vite - 280 g		0,072/16
	1068/300	Mop cotone filo fine con attacco a vite - 300 g		0,072/17
	Per uso semi professionale			
	1069/200	Mop cotone filo grosso con attacco a vite - 200 g	50	0,060/12
	1069/250	Mop cotone filo grosso con attacco a vite - 250 g		0,060/14,5
	1069/300	Mop cotone filo grosso con attacco a vite - 300 g		0,072/17
	1069/350	Mop cotone filo grosso con attacco a vite - 350 g		0,072/19,5
	Per uso semi professionale			
	4028/350	Mop cotone senza banda con foro - 350 g	50	0,090/19
	4028/400	Mop cotone senza banda con foro - 400 g		0,090/21,5
	4030/350	Mop cotone senza banda - 350 g	50	0,090/19
	4030/400	Mop cotone senza banda - 400 g		0,090/21,5
	4030/450	Mop cotone senza banda - 450 g		0,090/24
	4030/500	Mop cotone senza banda - 500 g		0,105/26,5
	4029/350	Mop cotone con banda con foro - 350 g	50	0,090/19
	4029/400	Mop cotone con banda con foro - 400 g		0,090/21,5
	4029/450	Mop cotone con banda con foro - 450 g		0,090/24

Codice	Descrizione	Conf.	Volume/Peso Conf. m ³ /kg
	4031/350 Mop cotone con banda - 350 g 4031/400 Mop cotone con banda - 400 g 4031/450 Mop cotone con banda - 450 g 4031/500 Mop cotone con banda - 500 g	50	0,090/19 0,090/21,5 0,090/24 0,105/26,5
TNT			
	1080 Mop TNT (pura viscosa) ad alto assorbimento con attacco a vite - 210 g	50	0,100/12
	1080/180 Mop TNT (poliestere e viscosa) ad alto assorbimento con attacco a vite - 180 g	50	
	4032/N Mop TNT (pura viscosa) ad alto assorbimento con attacco a pinza - 230 g	50	0,135/15,5
MICROFIBRA			
	60653 Mop in microfibra blu filo continuo con banda - 250 g	50	0,068/14,7

Codice	Descrizione	Conf.	Volume/Peso Conf. m ³ /kg
 4010 ● 4010/A ●	Pinza plastica per mop	100	0,06/10,4
 4001	Set composto da: pinza, mop e manico	1	





Manici e Aste Telescopiche

Manici e Aste Telescopiche



Ergonomici, leggeri e maneggevoli. Manici e aste telescopiche di dimensioni e diametri differenti per ogni tipo di esigenza.



NEW

SPRAY CLEAN. Manico serbatoio per il lavaggio e/o la disinfezione di pavimenti fino a 25 m² in più.









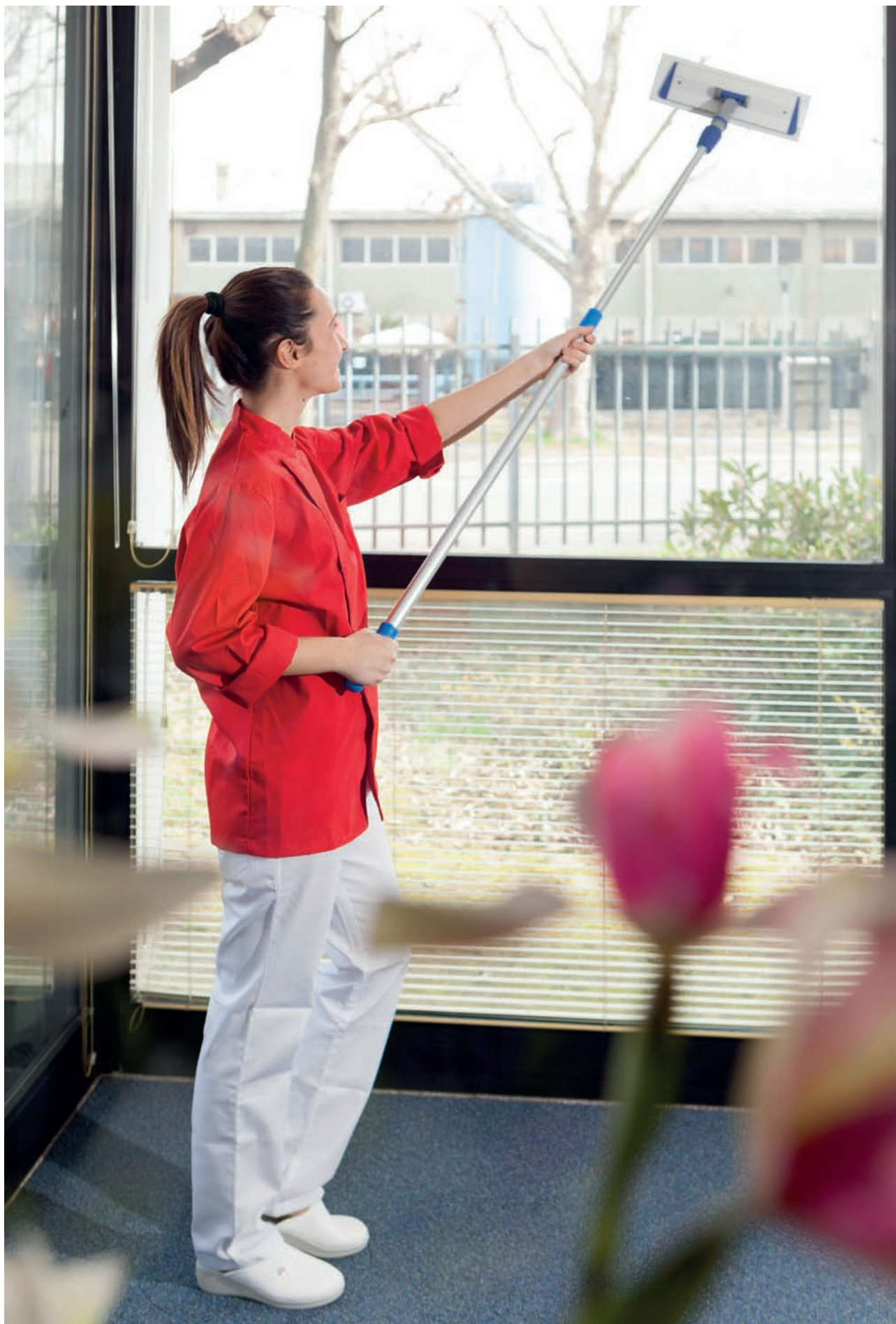



Manico serbatoio. Dotato di 3 fori per l'erogazione di acqua o acqua più detergente.









Massima praticità. Grazie allo speciale pomello, l'erogazione dell'acqua avviene direttamente dall'impugnatura.



	Codice	Descrizione	Conf.	Volume/Peso Conf. m ³ /kg
	4025	Manico alluminio anodizzato Ø 24 mm, 145 cm, con foro (1 pezzo)	25	0,048/10,3
	4421	Manico alluminio anodizzato Ø 23,5 mm, 140 cm, con foro (1 pezzo)	25	0,048/10
	4422	Manico alluminio anodizzato Ø 23,5 mm, 140 cm, con filetto (1 pezzo)	25	0,048/10
	4021	Manico alluminio anodizzato Ø 23 mm, 140 cm, con foro (2 pezzi)	50	0,070/15
	4426	Manico telescopico alluminio 160 cm, con foro (1 pezzo)	50	0,1/17

	Codice	Descrizione	Conf.	Volume/Peso Conf. m ³ /kg
	4019	Manico legno Ø 24 mm, 150 cm, con filetto e foro (1 pezzo)	50	0,048/24
	1058	Manico metallo verniciato Ø 22 mm, 130 cm, con filetto (1 pezzo)	20	0,030/8
	4016 4016/F	Manico telescopico verniciato 150 cm, con foro (1 pezzo) Manico telescopico verniciato 150 cm, con filetto (1 pezzo)	10	0,018/7,2
	4020	Manico cromato Ø 22 mm, 145 cm, con foro (2 pezzi)	25	0,033/16,5
	4089	Manico serbatoio SPRAY CLEAN da 500 ml	25	

	Codice	Descrizione	Conf.	Volume/Peso Conf. m ³ /kg
	4089/1	Manico serbatoio SPRAY CLEAN da 500 ml completo di telaio TRAPEZE in plastica	1	
	4013	Puntale conico multiuso con filetto. Adattabile al manico 4016		
	4022	Innesto con filetto per manico Ø 22 mm. Adattabile al manico 4020		
	4024	Innesto con filetto per manico Ø 24 mm. Adattabile ai manici 4025 e 4421		
	Aste telescopiche			
	32125	Asta telescopica - 2x1,25 mt		0,026/6,2
	32200	Asta telescopica - 2x2 mt		0,041/9,8
	33100	Asta telescopica - 3x1 mt		0,026/10,4
	33150	Asta telescopica - 3x1,50 mt	10	0,035/14,8
	33200	Asta telescopica - 3x2 mt		0,042/18,5
	33201	Asta telescopica - 3x3 mt		0,060/27,2
33203	Asta telescopica - 4+4+3 mt		0,100/35,5	
	33398	Snodo dentato in alluminio per asta telescopica	10	

Codice	Descrizione	Conf.	Volume/Peso Conf. m ³ /kg
 33402	Cono terminale filettato per asta telescopica	10	

Linea Vetri e Spingiacqua

Linea Vetri e Spingiacqua





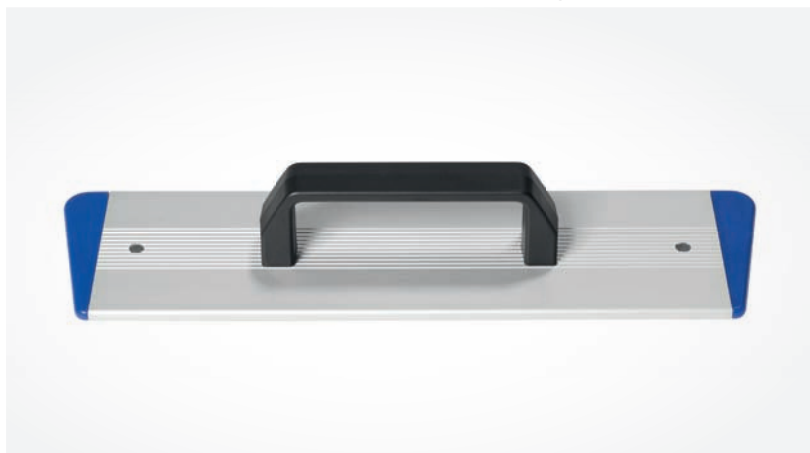







Domino System. Uno strumento a disposizione dell'operatore per l'efficace pulizia di superfici verticali (vetri, pareti, porte) e piane (scrivanie, davanzali e simili). Un telaio in due possibili versioni: con snodo per utilizzo con asta telescopica e con impugnatura per utilizzo manuale.













Impugnatura. L'impugnatura, realizzata in polipropilene è ergonomica e i due refill di aggrappo velcro, nella parte inferiore, sono sostituibili.













	Codice	Descrizione	Conf.	Volume/Peso Conf. m ³ /kg
	CLEANO			
	34800 34803	CLEANO asta telescopica - 2x70 cm CLEANO asta telescopica - 2x150 cm		0,019/1,9 0,032/2,6
	34802	Panno in ultramicrofibra per CLEANO - 10x26 cm	20	0,005/0,7
	34801	Borsa in nylon rinforzata per CLEANO		
DOMINO SYSTEM				
	34701	Telaio in alluminio DOMINO SYSTEM con impugnatura manuale e due refil di aggrappo velcro nella parte inferiore (sostituibili) - 28x8 cm	10	0,014/ 2,4
	34700	Telaio in alluminio DOMINO SYSTEM con snodo per utilizzo con asta telescopica e due refil di aggrappo velcro nella parte inferiore (sostituibili) - 28x8 cm	10	0,014/ 2,8





Codice	Descrizione	Conf.	Volume/Peso Conf. m ³ /kg
	34702 Panno in ultramicrofibra per DOMINO SYSTEM - 30x10 cm	20	0,005/0,9
Tergivetro			
	30525 Tergivetro inox completo - 25 cm 30530 Tergivetro inox completo - 30 cm 30535 Tergivetro inox completo - 35 cm 30540 Tergivetro inox completo - 40 cm 30545 Tergivetro inox completo - 45 cm 30550 Tergivetro inox completo - 50 cm 30555 Tergivetro inox completo - 55 cm	10	0,005/1,8 0,005/1,9 0,005/2 0,005/2,1 0,005/2,2 0,006/2,4 0,006/2,6
	30580 Impugnatura tergovetro in acciaio inox	10	0,005/1,1
	30225 Tergivetro Technolite completo - 25 cm 30235 Tergivetro Technolite completo - 35 cm 30245 Tergivetro Technolite completo - 45 cm 30255 Tergivetro Technolite completo - 55 cm	10	0,006/1,6 0,006/1,9 0,006/2,1 0,006/2,4
	30625 Supporto inox con gomma - 25 cm 30630 Supporto inox con gomma - 30 cm 30635 Supporto inox con gomma - 35 cm 30640 Supporto inox con gomma - 40 cm 30645 Supporto inox con gomma - 45 cm 30650 Supporto inox con gomma - 50 cm 30655 Supporto inox con gomma - 55 cm	25	0,003/1,5 0,005/1,9 0,005/2,3 0,005/2,5 0,005/2,9 0,006/ 3,1 0,006/ 3,5



	Codice	Descrizione	Conf.	Volume/Peso Conf. m ³ /kg
	30692	Gomma di ricambio - 92 cm	100	0,054/6
	30695	Gomma di ricambio - 71 cm		0,054/4,6
	30725	Tergivetro in plastica completo - 25 cm	10	0,007/0,87
	30730	Tergivetro in plastica completo - 30 cm		0,007/ 0,96
	30735	Tergivetro in plastica completo - 35 cm		0,007/1
	30740	Tergivetro in plastica completo - 40 cm		0,007/1,1
	30745	Tergivetro in plastica completo - 45 cm		0,007/1,2
Velli				
	33425	Vello lavavetri completo - 25 cm	100	0,151/12,4
	33435	Vello lavavetri completo - 35 cm	100	0,151/16
	33445	Vello lavavetri completo - 45 cm	50	0,151/10,2
	33426	Ricambio per vello - 25 cm	200	0,100/9
	33436	Ricambio per vello - 35 cm	200	0,100/10,1
	33446	Ricambio per vello - 45 cm	150	0,150/11,1
	33427	Supporto in plastica per vello - 25 cm	100	0,071/8,5
	33437	Supporto in plastica per vello - 35 cm	100	0,100/10,1
	33447	Supporto in plastica per vello - 45 cm	50	0,055/6,5

	Codice	Descrizione	Conf.	Volume/Peso Conf. m ³ /kg
	33412	Vello lavavetri con abrasivo completo - 25 cm	100	0,160/16,2
	33416	Vello lavavetri con abrasivo completo - 35 cm	100	0,160/20,7
	33420	Vello lavavetri con abrasivo completo - 45 cm	50	0,150/12,6
	33413	Ricambio per vello con abrasivo - 25 cm	200	0,100/12
	33417	Ricambio per vello con abrasivo - 35 cm	200	0,150/14
	33421	Ricambio per vello con abrasivo - 45 cm	150	0,150/13
	33535	Vello lavavetri in microfibra completo - 35 cm	100	0,151/16
	33545	Vello lavavetri in microfibra completo - 45 cm	50	0,151/10,2
	33536	Ricambio per vello microfibra - 35 cm	200	0,150/10
	33546	Ricambio per vello microfibra - 45 cm	150	0,150/11
Tergivetro snodati				
	31080	Impugnatura tergovetro snodato	10	0,007/1,9

	Codice	Descrizione	Conf.	Volume/Peso Conf. m ³ /kg
	31025	Tergivetro snodato completo - 25 cm	10	0,007/2,5
	31030	Tergivetro snodato completo - 30 cm	10	0,007/2,7
	31035	Tergivetro snodato completo - 35 cm	10	0,007/2,9
	31040	Tergivetro snodato completo - 40 cm	5	0,05/1,5
	31045	Tergivetro snodato completo - 45 cm	5	0,05/1,6
	30925	Supporto in ottone con gomma - 25 cm		0,05/2
	30930	Supporto in ottone con gomma - 30 cm		0,05/2,3
	30935	Supporto in ottone con gomma - 35 cm	25	0,05/2,9
	30940	Supporto in ottone con gomma - 40 cm		0,05/3,3
	30945	Supporto in ottone con gomma - 45 cm		0,05/3,6
Velli snodati				
	33423	Vello lavavetri snodato completo - 25 cm	100	0,150/18,5
	33433	Vello lavavetri snodato completo - 35 cm	100	0,150/23,1
	33443	Vello lavavetri snodato completo - 45 cm	50	0,150/15
	33428	Supporto per vello snodato - 25 cm		0,050/7
	33438	Supporto per vello snodato - 35 cm	50	0,050/9
	33448	Supporto per vello snodato - 45 cm		0,060/11
Raschietti				
	34010	Raschietto tascabile senza lama	12	

	Codice	Descrizione	Conf.	Volume/Peso Conf. m ³ /kg
	34011	Lama per rascietto tascabile	100	
	34000	Rascietto con impugnatura plastica	25	0,018/3,2
	34025 34120	Rascietto con manico - 25 cm Rascietto con manico - 120 cm	25 10	0,018/4,2 0,027/3,3
	34150	Lama ricambio per rascietto	200	
	34200	Dispenser con 10 lame per rascietto	10	

	Codice	Descrizione	Conf.	Volume/Peso Conf. m ³ /kg
	33500	Raschietto CLIP con 10 lame	50	
	33501	Lama ricambio per raschietto CLIP	300	
Attrezzi vari				
	33480	Scovolo per ragnatele	10	0,110/2,2
	2270 A ● 2270 R ●	Secchio rett. - 13 lt	25	0,150/23,5
	7030 B ● 7030 R ●	Secchio rett. - 22 lt	6	0,120/8,7

Codice	Descrizione	Conf.	Volume/Peso Conf. m ³ /kg
Spingiacqua			
	30345 Spingiacqua in metallo - 45 cm	72	0,087/26
	30355 Spingiacqua in metallo - 55 cm	72	0,128/29
	30375 Spingiacqua in metallo - 75 cm	36	0,107/20,5
	30435 Spingiacqua in plastica - 35 cm	30	0,073/6,8
	30445 Spingiacqua in plastica - 45 cm		0,092/9
	30455 Spingiacqua in plastica - 55 cm		0,109/9,4
	30475 Spingiacqua in plastica - 75 cm		0,137/11,9

Prodotti Vari Professionali

Tamponi e porta tamponi	242
Panni in microfibra	244
Pannelli segnalatori	247
Palette	248
Piumini spolvero	249

Prodotti Vari Professionali



BLU

Campo d'impiego: Tavoli / Scrivanie / Armadi / Vetri



VERDE

Campo d'impiego: Cucine / Mense / Bar

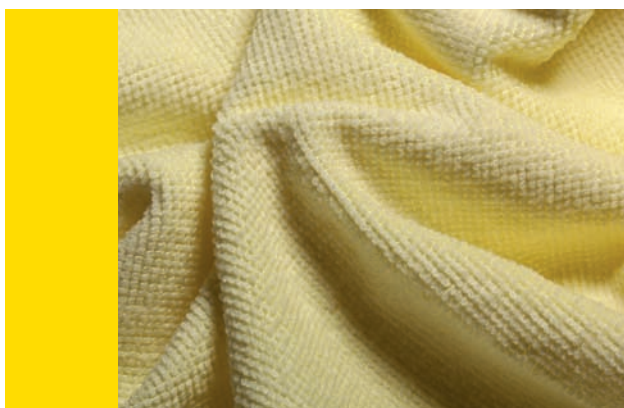

GIALLO

Campo d'impiego: Lavello / Box doccia / Vasca

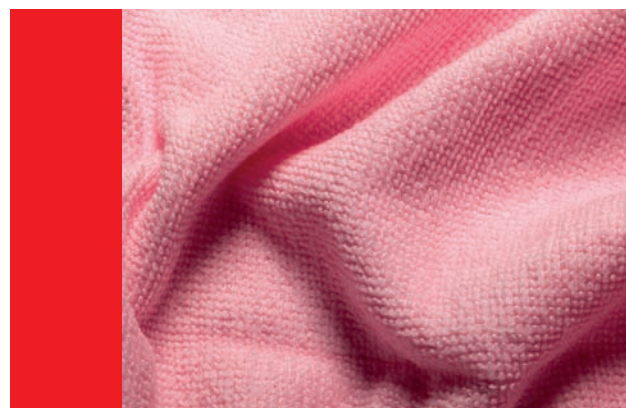

ROSSO

Campo d'impiego: Bidet / WC



Panni in microfibra: Particolarmente assorbenti, garantiscono alte prestazioni trattenendo sporco e batteri riducendo i tempi di lavoro del 25% - 30%.





Composizione del filato:





- 70% poliestere: resistenza all'usura, all'abrasione e ai lavaggi in lavatrice. Capacità di asportare e trattenere lo sporco.
- 30% poliammide: elevata forza meccanica. Capacità di trattenere lo sporco.





Grammature: 200 - 300 g/m²





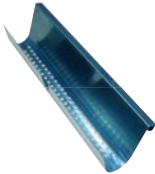







Spolverino professional. Ideale per la pulizia di superfici alte e verticali.





	Codice	Descrizione	Conf.	Volume/Peso Conf. m ³ /kg
		TOUCH FREE SYSTEM		
	KIT7027	Kit TOUCH FREE SYSTEM (Coppia alette per secchio rett. 22 lt - art. 7030)	1	
	KIT7026	Kit TOUCH FREE SYSTEM completo di telaio (art. 7026)	1	
		Tamponi e porta tamponi		
	4090	Portatampone con impugnatura fissa	15	0,014/3,1
	4091	Portatampone con snodo	12	0,014/2,4
	4078/BI ○ 4078/N ● 4078/R ● 4078/V ●	Tampone - 12x25 cm	12	0,010/0,5





	Codice	Descrizione	Conf.	Volume/Peso Conf. m ³ /kg
	4079/BI ○ 4079/N ● 4079/R ● 4079/V ●	Impugnatura con tampone - 15x10 cm	5	0,006/0,7
	Applicazione cera			
	33601	Attrezzo spandicera completo	10	0,054/10,84
	33602	Ricambio vello spandicera	10	
	7030 R ●	Secchio rett. - 22 lt	6	0,120/8,7
	7029	Set 4 ruote per secchio rett. 22 lt		





	Codice	Descrizione	Conf.	Volume/Peso Conf. m ³ /kg
	34600	Griglietta in acciaio inox	5	0,006/0,7
	4751 4752 4758 4730	Applicatore cera JUMBO-WAX con serbatoio 1,7 lt e telaio 40 cm (art. 7033) 1 Applicatore cera JUMBO-WAX con serbatoio 1,7 lt e telaio 60 cm (art. 4086 SS) 1 Serbatoio cera 2,5 lt 1 Portamanico 1		0,037/1,7 0,037/1,7
		(Fino ad esaurimento scorte)		
	Distributore disinfettante			
	4088	Distributore disinfettante completo di telaio in gomma lamellare (art. 4087), 4 flaconi (art. 4110)	1	0,046/3,2
	4170/B	Panno per distributore disinfettante (art. 4088)	20	
	Panni microfibra			
	3651 ● 3652 ● 3653 ● 3654 ●	Panno in microfibra 300 g/m ² - 40x40 cm	5x40	0,07/10

	Codice	Descrizione	Conf.	Volume/Peso Conf. m ³ /kg
	3655 ●●●●	Set da 4 pezzi panno in microfibra 200 g/m ² - 40x40 cm	Sets 50	0,06/8
	2060 B ● 2060 R ● 2060 J ● 2060 V ●	Panno in microfibra monocolore 200 g/m ² - 40x40 cm	5x20	
Pinze nipper				
	34540 34570 34599	Pinza multiuso - 40 cm Pinza multiuso - 70 cm Pinza multiuso - 100 cm	10	0,021/2,1 0,036/3 0,045/3,9
Prodotti vari				
	22065 22050 22051 22052 22053 22054	Cintura completa (4 elementi) Cintura portatasche (nuda) Tasca portaflacone (bordo blu) Tasca portaflacone (bordo rosso) Tasca portaoggetti Tasca portatelefono (Fino ad esaurimento scorte)		
	1071	Convogliatore acqua FAST		

	Codice	Descrizione	Conf.	Volume/Peso Conf. m ³ /kg
	GIPSY A/G ●●	Set multiuso GIPSY completo di: 5 separatori e 4 portamanico	2	0,100/8
	2306 ●	Secchiello vetri per GIPSY 47x12x30h cm		
	2310	Tracolla per GIPSY		
	21075 Microroll System	Sistema "rapido" di preparazione panni microfibra fortemente strizzati e pronti all'uso. Composto da: 1 pressa MICROROLL 1 secchio da 22 lt (grigio) 2 secchi da 6 lt (azzurro, rosso)		
	80077	Cassetta portaoggetti con ferma flaconi		

	Codice	Descrizione	Conf.	Volume/Peso Conf. m ³ /kg
Pannelli segnalatori				
	4260/1	Pannello segnalatore completo di 2 dischi segnaletici (PAVIMENTO SCIVOLOSO/PAVIMENTO BAGNATO)	10	0,100/13,5
	4263/2	Disco segnaletico (ATTENZIONE/PAVIMENTO SCIVOLOSO)		
	4263/3	Disco segnaletico (ATTENZIONE/PAVIMENTO BAGNATO)		
	4264	Disco segnaletico Blu (FRECCIA) (Fino ad esaurimento scorte)		
	4265	Disco segnaletico Rosso (DIVIETO)		

	Codice	Descrizione	Conf.	Volume/Peso Conf. m ³ /kg
	Palette e spolverini			
	4039	Paletta maxi (Fino ad esaurimento scorte)	24	0,043/3
	4040 SET	Set paletta con manico e scopa completa di gancio	8	0,075/7,4
		4350	Set paletta grande con manico, scopa in vinile e manico telescopico - 130 cm	8
		4380	Spolverino professional completo - 60 cm	12
	4381	Telaio per spolverino professional	12	0,027/2,8

Codice	Descrizione	Conf.	Volume/Peso Conf. m ³ /kg
	4382 Ricambio microfibra per spolverino professional	36	0,052/2,4
	4037 Piumino spolvero struzzo	30	0,069/3
	4038 Piumino spolvero lana	100	0,120/10
	4357 Piumino spolvero in materiale sintetico	100	0,120/10

Linea Sanità

DMX - Pre

254

Linea Sanità



Sistema di scopatura VELBOX. È provvisto di sistema di blocco dei panni monouso durante il trasporto.



Facilità. Il sistema VELBOX permette un facile ed ergonomico caricamento dei panni monouso.



Ergonomia. Il sistema VELBOX permette inoltre di bloccare i panni monouso al telaio evitando all'operatore piegamenti della schiena.



Cassetti. Possono essere dotati di coperchi ermetici per la pre-impregnazione e possono essere facilmente impilati in office o in magazzino.



Spazio strutturato. La versione SPACE è stata studiata per coloro che hanno esigenze di ulteriore spazio di carico.



Tutto a portata di mano. Il dosatore Tecno-Shower può essere facilmente riposto nel carrello.



Sicurezza. Dotati di un'unica serratura in metallo che blocca l'intera colonna dei cassetti. Inoltre è prevista una vaschetta basculante per riporre piccoli oggetti.



Codice	Descrizione	Colore
--------	-------------	--------

DMX COMPACT Carrello multiuso in plastica carenato 900.2

21001AB/DMX	1 Base IDEA/AB completa di 4 ruote morbide per esterno Ø 125 mm (art. 21027)	●
21003 B	1 Finalino per base	●
25050	1 Montante senza serratura DMX - 2 cassetti	●
25052	1 Montante con serratura DMX - 2 cassetti	●
23020 G	1 Secchio 4 lt	●
23020 R	1 Secchio 4 lt	●
2250 BA	1 Secchio 6 lt	●
25066 A	1 Cassetto 30 lt DMX	●
25066/P	1 Cassetto 30 lt con paracolpi	●
25060	1 Coperchio per cassetti	●
23024/N	1 Cestello portasecchi in plastica senza portamanico e gancio MX/DMX	●
23005 BA	1 Reggisacco MX/DMX completo di 4 portamanico, coperchio con leggio e cursore scorrevole	●
25064	2 Vaschette portachiaavi DMX	●
23003/1	1 Vaschetta portasecchi superiore MX/DMX	●
KITDMXPRE/A	1 Kit montaggio DMX COMPACT 900	●

Codice	Descrizione	Colore
--------	-------------	--------

DMX COMPACT Carrello multiuso in plastica carenato 900.3

21001AB/DMX	1 Base IDEA/AB completa di 4 ruote morbide per esterno Ø 125 mm (art. 21027)	●
21003 B	1 Finalino per base	●
25051	1 Montante senza serratura DMX - 3 cassetti	●
25053	1 Montante con serratura DMX - 3 cassetti	●
23020 G	1 Secchio 4 lt	●
23020 R	1 Secchio 4 lt	●
2250 BA	1 Secchio 6 lt	●
25065 A	1 Cassetto 20 lt DMX	●
25065/P	2 Cassetti 20 lt con paracolpi	●
25060	2 Coperchi per cassetti	●
23024/N	1 Cestello portasecchi in plastica senza portamanico e gancio MX/DMX	●
23005 BA	1 Reggisacco MX/DMX completo di 4 portamanico, coperchio con leggio e cursore scorrevole	●
25064	2 Vaschette portachiaavi DMX	●
23003/1	1 Vaschetta portasecchi superiore MX/DMX	●
KITDMXPRE/A	1 Kit montaggio DMX COMPACT 900	●

83x56x105h cm | 1 Pz/cartone 25,1 Kg 0,390 m³

83x56x105h cm | 1 Pz/cartone 25,9 Kg 0,390 m³



Codice Descrizione Colore

DMX COMPACT Carrello multiuso in plastica carenato 1000.2

21001AB/COMPACT	1 Base IDEA/AB completa di 4 ruote morbide per esterno Ø 125 mm (art. 21027) e fermo sportelli	●
21003 B	1 Finalino per base	●
25050	1 Montante senza serratura DMX - 2 cassette	●
25052	1 Montante con serratura DMX - 2 cassette	●
23011N	1 Sportello sx MX/DMX	○
23012N	1 Sportello dx MX/DMX	○
23020 G	1 Secchio 4 lt	●
23020 R	1 Secchio 4 lt	●
2250 BA	1 Secchio 6 lt	●
25066 A	1 Cassetto 30 lt DMX	●
25066/P	1 Cassetto 30 lt con paracolpi	●
25060	1 Coperchio per cassette	●
23024/N	1 Cestello portasecchi in plastica senza portamanico e gancio MX/DMX	●
23005 BA	1 Reggisacco MX/DMX completo di 4 portamanico, coperchio con leggio e cursore scorrevole	●
25064	2 Vaschette portachiavi DMX	●
23003/1	1 Vaschetta portasecchi superiore MX/DMX	●
KITDMXPRE/B	1 Kit montaggio DMX COMPACT 1000-4000	●

Codice Descrizione Colore

DMX COMPACT Carrello multiuso in plastica carenato 1000.3

21001AB/COMPACT	1 Base IDEA/AB completa di 4 ruote morbide per esterno Ø 125 mm (art. 21027) e fermo sportelli	●
21003 B	1 Finalino per base	●
25051	1 Montante senza serratura DMX - 3 cassette	●
25053	1 Montante con serratura DMX - 3 cassette	●
23011N	1 Sportello sx MX/DMX	○
23012N	1 Sportello dx MX/DMX	○
23020 G	1 Secchio 4 lt	●
23020 R	1 Secchio 4 lt	●
2250 BA	1 Secchio 6 lt	●
25065 A	1 Cassetto 20 lt DMX	●
25065/P	2 Cassetto 20 lt con paracolpi	●
25060	2 Coperchi per cassette	●
23024/N	1 Cestello portasecchi in plastica senza portamanico e gancio MX/DMX	●
23005 BA	1 Reggisacco MX/DMX completo di 4 portamanico, coperchio con leggio e cursore scorrevole	●
25064	2 Vaschette portachiavi DMX	●
23003/1	1 Vaschetta portasecchi superiore MX/DMX	●
KITDMXPRE/B	1 Kit montaggio DMX COMPACT 1000-4000	●

83x56x105h cm | 1 Pz/cartone 29,7 Kg 0,390 m³

83x56x105h cm | 1 Pz/cartone 30,5 Kg 0,390 m³



Codice	Descrizione	Colore
--------	-------------	--------

DMX COMPACT Carrello multiuso in plastica carenato 2000.2

21001AB/COMPACT	1 Base IDEA/AB completa di 4 ruote morbide per esterno Ø 125 mm (art. 21027) e fermo sportelli	●
21003 B	1 Finalino per base	●
25050	1 Montante senza serratura DMX - 2 cassetti	●
25052	1 Montante con serratura DMX - 2 cassetti	●
23011N	1 Sportello sx MX/DMX	○
23012N	1 Sportello dx MX/DMX	○
23020 B	2 Secchi 4 lt	●
23020 G	1 Secchio 4 lt	●
23020 R	1 Secchio 4 lt	●
2250 BA	1 Secchio 6 lt	●
25066 A	1 Cassetto 30 lt DMX	●
25066/P	1 Cassetto 30 lt con paracolpi	●
25060	1 Coperchio per cassetti	●
23023 KIT	1 Kit cestello portasecchi 4 lt in rilsan	●
23024/N	1 Cestello portasecchi in plastica senza portamanico e gancio MX/DMX	●
23005 BA	1 Reggisacco MX/DMX completo di 4 portamanico, coperchio con leggio e cursore scorrevole	●
24057 KIT	1 Kit supporto VELBOX in rilsan	●
VELBOX	1 Portaveline completo VELBOX	●
25064	2 Vaschette portachiavi DMX	●
23003/1	1 Vaschetta portasecchi superiore MX/DMX	●
KITDMXPRE/C	1 Kit montaggio DMX COMPACT 2000-3000	●

Codice	Descrizione	Colore
--------	-------------	--------

DMX COMPACT Carrello multiuso in plastica carenato 2000.3

21001AB/COMPACT	1 Base IDEA/AB completa di 4 ruote morbide per esterno Ø 125 mm (art. 21027) e fermo sportelli	●
21003 B	1 Finalino per base	●
25051	1 Montante senza serratura DMX - 3 cassetti	●
25053	1 Montante con serratura DMX - 3 cassetti	●
23011N	1 Sportello sx MX/DMX	○
23012N	1 Sportello dx MX/DMX	○
23020 B	2 Secchi 4 lt	●
23020 G	1 Secchio 4 lt	●
23020 R	1 Secchio 4 lt	●
2250 BA	1 Secchio 6 lt	●
25065 A	1 Cassetto 20 lt DMX	●
25065/P	2 Cassetti 20 lt con paracolpi	●
25060	2 Coperchi per cassetti	●
23023 KIT	1 Kit cestello portasecchi 4 lt in rilsan	●
23024/N	1 Cestello portasecchi in plastica senza portamanico e gancio MX/DMX	●
23005 BA	1 Reggisacco MX/DMX completo di 4 portamanico, coperchio con leggio e cursore scorrevole	●
24057 KIT	1 Kit supporto VELBOX in rilsan	●
VELBOX	1 Portaveline completo VELBOX	●
25064	2 Vaschette portachiavi DMX	●
23003/1	1 Vaschetta portasecchi superiore MX/DMX	●
KITDMXPRE/C	1 Kit montaggio DMX COMPACT 2000-3000	●

105x56x105h cm | 1 Pz/cartone | 32,3 Kg | 0,390 m³

105x56x105h cm | 1 Pz/cartone | 33,2 Kg | 0,390 m³



Codice Descrizione Colore

DMX COMPACT Carrello multiuso in plastica carenato 3000.2

21001AB/COMPACT	1 Base IDEA/AB completa di 4 ruote morbide per esterno Ø 125 mm (art. 21027) e fermo sportelli	●
21003 B	1 Finalino per base	●
25050	1 Montante senza serratura DMX - 2 cassetti	●
25052	1 Montante con serratura DMX - 2 cassetti	●
23011N	1 Sportello sx MX/DMX	○
23012N	1 Sportello dx MX/DMX	○
23020 B	4 Secchi 4 lt	●
23020 G	1 Secchio 4 lt	●
23020 R	1 Secchio 4 lt	●
2250 BA	1 Secchio 6 lt	●
25066 A	1 Cassetto 30 lt DMX	●
25066/P	1 Cassetto 30 lt con paracolpi	●
25060	1 Coperchio per cassetti	●
23023 KIT	2 Kit cestelli portasecchi 4 lt in rilsan	●
23024/N	1 Cestello portasecchi in plastica senza portamanico e gancio MX/DMX	●
23005 BA	1 Reggisacco MX/DMX completo di 4 portamanico, coperchio con leggio e cursore scorrevole	●
25064	2 Vaschette portachiaavi DMX	●
23003/1	1 Vaschetta portasecchi superiore MX/DMX	●
KITDMXPRE/C	1 Kit montaggio DMX COMPACT 2000-3000	

Codice Descrizione Colore

DMX COMPACT Carrello multiuso in plastica carenato 3000.3

21001AB/COMPACT	1 Base IDEA/AB completa di 4 ruote morbide per esterno Ø 125 mm (art. 21027) e fermo sportelli	●
21003 B	1 Finalino per base	●
25051	1 Montante senza serratura DMX - 3 cassetti	●
25053	1 Montante con serratura DMX - 3 cassetti	●
23011N	1 Sportello sx MX/DMX	○
23012N	1 Sportello dx MX/DMX	○
23020 B	4 Secchi 4 lt	●
23020 G	1 Secchio 4 lt	●
23020 R	1 Secchio 4 lt	●
2250 BA	1 Secchio 6 lt	●
25065 A	1 Cassetto 20 lt DMX	●
25065/P	2 Cassetti 20 lt con paracolpi	●
25060	2 Coperchi per cassetti	●
23023 KIT	2 Kit cestelli portasecchi 4 lt in rilsan	●
23024/N	1 Cestello portasecchi in plastica senza portamanico e gancio MX/DMX	●
23005 BA	1 Reggisacco MX/DMX completo di 4 portamanico, coperchio con leggio e cursore scorrevole	●
25064	2 Vaschette portachiaavi DMX	●
23003/1	1 Vaschetta portasecchi superiore MX/DMX	●
KITDMXPRE/C	1 Kit montaggio DMX COMPACT 2000-3000	

105x56x105h cm | 1 Pz/cartone | 32,2 Kg | 0,390 m³

105x56x105h cm | 1 Pz/cartone | 33,1 Kg | 0,390 m³



Codice	Descrizione	Colore
--------	-------------	--------

DMX COMPACT Carrello multiuso in plastica carenato 4000.2

21001AB/COMPACT	1 Base IDEA/AB completa di 4 ruote morbide per esterno Ø 125 mm (art. 21027) e fermo sportelli	●
21003 B	1 Finalino per base	●
25050	1 Montante senza serratura DMX - 2 cassetti	●
25052	1 Montante con serratura DMX - 2 cassetti	●
23011N	1 Sportello sx MX/DMX	○
23012N	1 Sportello dx MX/DMX	○
23020 G	1 Secchio 4 lt	●
23020 R	1 Secchio 4 lt	●
2250 BA	1 Secchio 6 lt	●
25066 A	1 Cassetto 30 lt DMX	●
25065/P	1 Cassetto 20 lt con paracolpi	●
25066/P	1 Cassetto 30 lt con paracolpi	●
25060	1 Coperchio per cassetti	●
23024/N	1 Cestello portasecchi in plastica senza portamanico e gancio MX/DMX	●
23005 BA	1 Reggisacco MX/DMX completo di 4 portamanico, coperchio con leggio e cursore scorrevole	●
25064	2 Vaschette portachiaavi DMX	●
23003/1	1 Vaschetta portasecchi superiore MX/DMX	●
23046	1 Cestello portasecchio 22 lt in rilsan MX/DMX	●
KITDMXPRE/B	1 Kit montaggio DMX COMPACT 1000-4000	●

Codice	Descrizione	Colore
--------	-------------	--------

DMX COMPACT Carrello multiuso in plastica carenato 4000.3

21001AB/COMPACT	1 Base IDEA/AB completa di 4 ruote morbide per esterno Ø 125 mm (art. 21027) e fermo sportelli	●
21003 B	1 Finalino per base	●
25051	1 Montante senza serratura DMX - 3 cassetti	●
25053	1 Montante con serratura DMX - 3 cassetti	●
23011N	1 Sportello sx MX/DMX	○
23012N	1 Sportello dx MX/DMX	○
23020 G	1 Secchio 4 lt	●
23020 R	1 Secchio 4 lt	●
2250 BA	1 Secchio 6 lt	●
25065 A	1 Cassetto 20 lt DMX	●
25065/P	3 Cassetti 20 lt con paracolpi	●
25060	2 Coperchi per cassetti	●
23024/N	1 Cestello portasecchi in plastica senza portamanico e gancio MX/DMX	●
23005 BA	1 Reggisacco MX/DMX completo di 4 portamanico, coperchio con leggio e cursore scorrevole	●
25064	2 Vaschette portachiaavi DMX	●
23003/1	1 Vaschetta portasecchi superiore MX/DMX	●
23046	1 Cestello portasecchio 22 lt in rilsan MX/DMX	●
KITDMXPRE/B	1 Kit montaggio DMX COMPACT 1000-4000	●

83x56x105h cm | 1 Pz/cartone 31,1 Kg 0,390 m³

83x56x105h cm | 1 Pz/cartone 31,9 Kg 0,390 m³



Codice Descrizione Colore

DMX COMPACT Carrello multiuso in plastica carenato 5000.2

21001AB/COMPACT	1 Base IDEA/AB completa di 4 ruote morbide per esterno Ø 125 mm (art. 21027) e fermo sportelli	●
21003 B	1 Finalino per base	●
25050	1 Montante senza serratura DMX - 2 cassetti	●
25052	1 Montante con serratura DMX - 2 cassetti	●
23011N	1 Sportello sx MX/DMX	○
23012N	1 Sportello dx MX/DMX	○
23020 G	1 Secchio 4 lt	●
23020 R	1 Secchio 4 lt	●
2250 BA	1 Secchio 6 lt	●
25066 A	1 Cassetto 30 lt DMX	●
25065/P	1 Cassetto 20 lt con paracolpi	●
25066/P	1 Cassetto 30 lt con paracolpi	●
25060	2 Coperchi per cassetti	●
23024/N	1 Cestello portasecchi in plastica senza portamanico e gancio MX/DMX	●
23005 BA	1 Reggisacco MX/DMX completo di 4 portamanico, coperchio con leggio e cursore scorrevole	●
23000 KIT	1 Kit estensione porta vassoio in rilsan DMX	
7079	1 Supporto in rilsan per dosatore Tecno-Shower	
7080	1 Dosatore Tecno-Shower	●
24057 KIT	1 Kit supporto VELBOX in rilsan	
VELBOX	1 Portaveline completo VELBOX	
25064	2 Vaschette portachavi DMX	●
23003/1	1 Vaschetta portasecchi superiore MX/DMX	●
23046	1 Cestello portasecchio 22 lt in rilsan MX/DMX	
KITDMXPRE/D	1 Kit montaggio DMX COMPACT 5000	

Codice Descrizione Colore

DMX COMPACT Carrello multiuso in plastica carenato 5000.3

21001AB/COMPACT	1 Base IDEA/AB completa di 4 ruote morbide per esterno Ø 125 mm (art. 21027) e fermo sportelli	●
21003 B	1 Finalino per base	●
25051	1 Montante senza serratura DMX - 3 cassetti	●
25053	1 Montante con serratura DMX - 3 cassetti	●
23011N	1 Sportello sx MX/DMX	○
23012N	1 Sportello dx MX/DMX	○
23020 G	1 Secchio 4 lt	●
23020 R	1 Secchio 4 lt	●
2250 BA	1 Secchio 6 lt	●
25065 A	1 Cassetto 20 lt DMX	●
25065/P	3 Cassetti 20 lt con paracolpi	●
25060	3 Coperchi per cassetti	●
23024/N	1 Cestello portasecchi in plastica senza portamanico e gancio MX/DMX	●
23005 BA	1 Reggisacco MX/DMX completo di 4 portamanico, coperchio con leggio e cursore scorrevole	●
23000 KIT	1 Kit estensione porta vassoio in rilsan DMX	
7079	1 Supporto in rilsan per dosatore Tecno-Shower	
7080	1 Dosatore Tecno-Shower	●
24057 KIT	1 Kit supporto VELBOX in rilsan	
VELBOX	1 Portaveline completo VELBOX	
25064	2 Vaschette portachavi DMX	●
23003/1	1 Vaschetta portasecchi superiore MX/DMX	●
23046	1 Cestello portasecchio 22 lt in rilsan MX/DMX	
KITDMXPRE/D	1 Kit montaggio DMX COMPACT 5000	

83x56x155h cm 1 Pz/2 cartone 36,2 Kg 0,490 m³

83x56x155h cm 1 Pz/2 cartone 37,1 Kg 0,490 m³



Codice	Descrizione	Colore
DMX SPACE 900.2	Carrello multiuso in plastica carenato	
21001AB/DMX	1 Base IDEA/AB completa di 4 ruote morbide per esterno Ø 125 mm (art. 21027)	●
21002IDEA/DMX	1 Prolunga con ruota morbida per esterno Ø 125 mm (art. 21027) e fermo sportelli	●
25050	1 Montante senza serratura DMX - 2 cassetti	●
25052	1 Montante con serratura DMX - 2 cassetti	●
23011N	1 Sportello sx MX/DMX	○
23012N	1 Sportello dx MX/DMX	○
23020 G	1 Secchio 4 lt	●
23020 R	1 Secchio 4 lt	●
2250 BA	1 Secchio 6 lt	●
2250 G	1 Secchio 6 lt	●
2250 VS	1 Secchio 6 lt	●
2253	2 Separatori flaconi per secchio 6 lt	●
25066 A	1 Cassetto 30 lt DMX	●
25066/P	1 Cassetto 30 lt con paracolpi	●
25060	1 Coperchio per cassetti	●
23005 BA	1 Reggisacco MX/DMX completo di 4 portamanico, coperchio con leggio e cursore scorrevole	●
23016 KIT	1 Kit ripiano portavassoio interno in rilsan DMX	●
25064	2 Vaschette portachiaavi DMX	●
23003/1	1 Vaschetta portasecchi superiore MX/DMX	●
KITDMXPRE/E	1 Kit montaggio DMX SPACE 900	●

Codice	Descrizione	Colore
DMX SPACE 900.3	Carrello multiuso in plastica carenato	
21001AB/DMX	1 Base IDEA/AB completa di 4 ruote morbide per esterno Ø 125 mm (art. 21027)	●
21002IDEA/DMX	1 Prolunga con ruota morbida per esterno Ø 125 mm (art. 21027) e fermo sportelli	●
25051	1 Montante senza serratura DMX - 3 cassetti	●
25053	1 Montante con serratura DMX - 3 cassetti	●
23011N	1 Sportello sx MX/DMX	○
23012N	1 Sportello dx MX/DMX	○
23020 G	1 Secchio 4 lt	●
23020 R	1 Secchio 4 lt	●
2250 BA	1 Secchio 6 lt	●
2250 G	1 Secchio 6 lt	●
2250 VS	1 Secchio 6 lt	●
2253	2 Separatori flaconi per secchio 6 lt	●
25065 A	1 Cassetto 20 lt DMX	●
25065/P	2 Cassetti 20 lt con paracolpi	●
25060	2 Coperchi per cassetti	●
23005 BA	1 Reggisacco MX/DMX completo di 4 portamanico, coperchio con leggio e cursore scorrevole	●
23016 KIT	1 Kit ripiano portavassoio interno in rilsan DMX	●
25064	2 Vaschette portachiaavi DMX	●
23003/1	1 Vaschetta portasecchi superiore MX/DMX	●
KITDMXPRE/E	1 Kit montaggio DMX SPACE 900	●

110x56x105h cm | 1 Pz/cartone | 32,7 Kg | 0,390 m³

110x56x105h cm | 1 Pz/cartone | 33,5 Kg | 0,390 m³



Codice	Descrizione	Colore
--------	-------------	--------

DMX SPACE 1000.2 Carrello multiuso in plastica carenato

21001AB/COMPACT	1 Base IDEA/AB completa di 4 ruote morbide per esterno Ø 125 mm (art. 21027) e fermo sportelli	●
21002IDEA/DMX	1 Prolunga con ruota morbida per esterno Ø 125 mm (art. 21027) e fermo sportelli	●
25050	1 Montante senza serratura DMX - 2 cassetti	●
25052	1 Montante con serratura DMX - 2 cassetti	●
23011N	2 Sportelli sx MX/DMX	○
23012N	2 Sportelli dx MX/DMX	○
23020 G	1 Secchio 4 lt	●
23020 R	1 Secchio 4 lt	●
2250 BA	1 Secchio 6 lt	●
2250 G	1 Secchio 6 lt	●
2250 VS	1 Secchio 6 lt	●
2253	2 Separatori flaconi per secchio 6 lt	●
25066 A	1 Cassetto 30 lt DMX	●
25066/P	1 Cassetto 30 lt con paracolpi	●
25060	1 Coperchio per cassetti	●
23005 BA	1 Reggisacco MX/DMX completo di 4 portamanico, coperchio con leggio e cursore scorrevole	●
23016 KIT	1 Kit ripiano portavassoio interno in rilsan DMX	●
25064	2 Vaschette portachiaavi DMX	●
23003/1	1 Vaschetta portasecchi superiore MX/DMX	●
KITDMXPRE/F	1 Kit montaggio DMX SPACE 1000	●











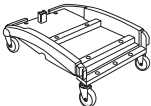

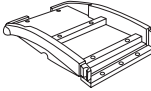

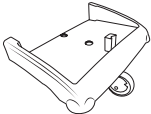
Codice	Descrizione	Colore
--------	-------------	--------

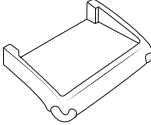

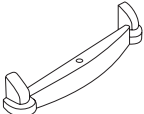

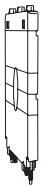
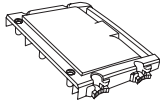
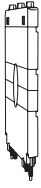

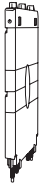
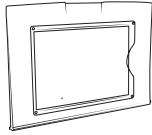
DMX SPACE 1000.3 Carrello multiuso in plastica carenato

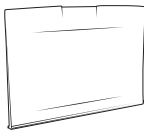

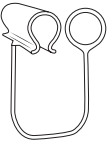

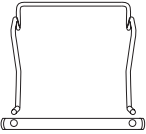
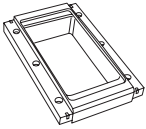
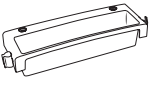

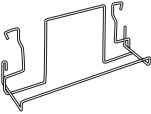

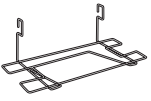

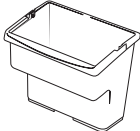

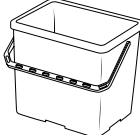

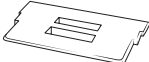

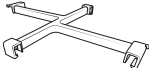

21001AB/COMPACT	1 Base IDEA/AB completa di 4 ruote morbide per esterno Ø 125 mm (art. 21027) e fermo sportelli	●
21002IDEA/DMX	1 Prolunga con ruota morbida per esterno Ø 125 mm (art. 21027) e fermo sportelli	●
25051	1 Montante senza serratura DMX - 3 cassetti	●
25053	1 Montante con serratura DMX - 3 cassetti	●
23011N	2 Sportelli sx MX/DMX	○
23012N	2 Sportelli dx MX/DMX	○
23020 G	1 Secchio 4 lt	●
23020 R	1 Secchio 4 lt	●
2250 BA	1 Secchio 6 lt	●
2250 G	1 Secchio 6 lt	●
2250 VS	1 Secchio 6 lt	●
2253	2 Separatori flaconi per secchio 6 lt	●
25065 A	1 Cassetto 20 lt DMX	●
25065/P	2 Cassetti 20 lt con paracolpi	●
25060	2 Coperchi per cassetti	●
23005 BA	1 Reggisacco MX/DMX completo di 4 portamanico, coperchio con leggio e cursore scorrevole	●
23016 KIT	1 Kit ripiano portavassoio interno in rilsan DMX	●
25064	2 Vaschette portachiaavi DMX	●
23003/1	1 Vaschetta portasecchi superiore MX/DMX	●
KITDMXPRE/F	1 Kit montaggio DMX SPACE 1000	●

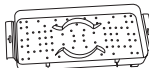

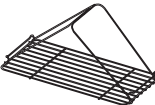

110x56x105h cm | 1 Pz/2 cartone 34,1 Kg 0,550 m³

110x56x105 cm | 1 Pz/2 cartone 34,9 Kg 0,550 m³

Codice	Descrizione	Colore	Codice	Descrizione	Colore
	21001 AB/COMPACT Base IDEA/AB completa di 4 ruote morbide per esterno Ø 125 mm (art. 21027) e fermo sportelli	●		23014 Chiave per serrature MX e DMX	
	21001 VS Base IDEA/AB senza ruote	●		23011N Sportello sx MX/DMX	○
	21002 IDEA/DMX Prolunga con ruota morbida per esterno Ø 125 mm (art. 21027) e fermo sportelli	●		23012N Sportello dx MX/DMX	○
	21002 B Prolunga senza ruota per base	●		23010 N Coppia sportelli MX/DMX	○
	21003 B Finalino per base	●		23080 Maniglia di chiusura per sportelli MX/DMX	●
	25050 Montante senza serratura DMX - 2 cassetti			23005 BA Reggisacco MX/DMX completo di 4 portamanico, coperchio con leggio e cursore scorrevole	●
	25051 Montante senza serratura DMX - 3 cassetti			23005/100B Reggisacco MX/DMX senza coperchio completo di 4 portamanico	●
	25052 Montante con serratura DMX - 2 cassetti			23006 B Coperchio con leggio per reggisacco plastica	●
	25053 Montante con serratura DMX - 3 cassetti			23006/N Coperchio senza leggio per reggisacco plastica	●

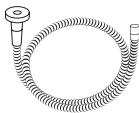
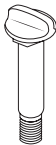
Codice	Descrizione	Colore	Codice	Descrizione	Colore	
	1701	Clip fermasacco con anello	●	VELBOX	Portaveline completo	
	2709	Separatore con clip per reggisacco plastica	●	23015 GR	Vassoio MX	○
	23100	Portarotolo per reggisacco plastica		25065/P	Cassetto 20 lt con paracolpi	
	23003/1	Vaschetta portasecchi superiore MX/DMX	●	25065 A 25065 G 25065 R 25065 V	Cassetto 20 lt DMX	● ● ● ●
	23024	Cestello portasecchi in plastica con portamanico e gancio MX/DMX	●	25066/P	Cassetto 30 lt con paracolpi	
	23000 KIT	Kit estensione portavassoio in rilsan composto da: - estensione rilsan - vassoio MX (art. 23015 GR)		25066 A 25066 G 25066 R 25066 V	Cassetto 30 lt DMX	● ● ● ●
	23023 KIT	Kit portasecchi 2x4lt rilsan composto da: - cestello portasecchi 2x4lt rilsan - cerniera inox dx (art. 23070), sx (art. 23071) - 4 viti autofilettanti inox 4,2x16 (art. 4221)		25069 25070	Frontale cassetto 20 lt DMX Frontale cassetto 30 lt DMX	● ●
	23016 KIT	Kit ripiano portavassoio rilsan composto da: - ripiano portavassoio rilsan (art. 23016) - vassoio pl. centrale MX (art. 23015 GR)		25067	Paracolpi cassetto	○
	24057 KIT	Kit VELBOX rilsan composto da: - supporto VELBOX in rilsan - cerniera inox dx (art. 23070), sx (art. 23071) - 4 viti autofilettanti inox 4,2x16 (art. 4221)		25060	Coperchio per cassette	●

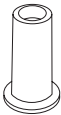
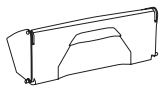
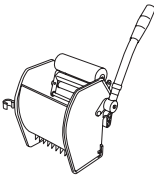
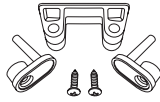
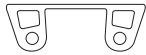
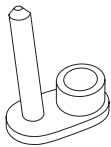
	Codice	Descrizione	Colore		Codice	Descrizione	Colore
	23020 B 23020 G 23020 R 23020 VS	Secchio 4 lt	● ● ● ●		21008	Ruota in gomma naturale Ø 100 mm s/freno con filetto 10x15	
	2250 BA 2250 G 2250 R 2250 VS	Secchio 6 lt	● ● ● ●		21009	Ruota in gomma naturale Ø 100 mm c/freno con filetto 10x15	
	23021	Coperchio per secchio 4 lt	●		21027	Ruota morbida per esterno Ø 125 mm	
	2253	Separatore flaconi per secchio 6 lt	●		21028	Ruota morbida per esterno Ø 125 mm spec s/freno (Abbinabile solo con cod. 21029)	
	7079	Supporto in rilsan per dosatore Tecno-Shower			21029	Ruota morbida per esterno Ø 125 mm spec c/freno (Abbinabile solo con cod. 21028)	
	7080	Dosatore Tecno-Shower	●		24060	Ruota Ø 100 mm con filetto 10x15	
	7032	Griglia inox pieghevole (per secchio rett. 22 lt)			24061	Ruota Ø 100 mm XL s/freno con filetto 10x15	
	23095	Sacco in rete 70 lt con laccio di chiusura			24062	Ruota Ø 100 mm XL c/freno con filetto 10x15	
	23097	Sacco in rete per secchio 22 lt con laccio di chiusura			21012	Ruota Ø 125 mm s/freno con filetto 10x15	

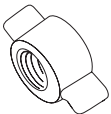
Codice	Descrizione	Colore	Codice	Descrizione	Colore
	1071 Convogliatore acqua FAST			21035 B Perno filettato	●
	4260/1 Pannello segnalatore (PAVIMENTO SCIIVOLOSO / PAVIMENTO BAGNATO)			21030 B Tappo per base	●
	25064 Vaschetta portachiaavi DMX	●		3501 VDM Strizzatore a rullo ELPAROLL	
	KIT23030 Kit portamanico in gomma				
	23030 Gomma portamanico				
	23031 Supportino per gomma portamanico	●			
	2231/G Gancio senza aggancio	●			
	2230/DMX Portamanico senza aggancio per cestello portafiacconi	○			
	21036 Ghiera filettata con alette	●			

Linea Hotel

Classic	270
Innovative	280
Elba	294

Linea Hotel



Fissaggio ruote. Applicate con supporto fissato in quattro punti saldamente tenuti tra la sede ricavata nella base e una piastra acciaio inox spessore mm 1,5.



La struttura. Tubo quadro, spessore 1,5 mm e verniciatura in polvere epossidica antigraffio.



Praticità. Pratici vassoi porta linea cortesia in plastica.



Modulare. Dotati di due pratici ripiani regolabili in altezza per la biancheria pulita.



Paracolpi. Dotati di paracolpi sporgenti in gomma su tutto il perimetro della base e sul reggisacco per proteggere mobili e pareti dagli urti.



Modularità e flessibilità. Portasacco reclinabili che permettono di diminuire l'ingombro del carrello.



Codice	Descrizione	Colore
90002	Carrello hotel PORTOFINO 1 (noce) in acciaio con verniciatura antigraffio	
90052	1 Base PORTOFINO con 2 ruote in gomma naturale Ø 150 mm c/freno (art. 90051) e 2 s/freno (art. 90050)	
90056	2 Spalle hotel noce	
GR7043/V	1 Reggisacco mobile hotel con anello in gomma	
90090	1 Set reggisacco e portasacco reclinabili con paracolpi, completo di piastre di fissaggio e sacco cotone sanforizzato 120 lt	
90057	1 Schienale PORTOFINO	
90054	1 Asta di fissaggio PORTOFINO	
GR90058	1 Asta di fissaggio con inserto per PORTOFINO	
2025/M	1 Vassoio piccolo	
90053	3 Ripiani PORTOFINO	
KITCLASSIC/A	1 Kit montaggio PORTOFINO/AMALFI/VENEZIA 1	

Da 8 a 12 camere

Codice	Descrizione	Colore
90004	Carrello hotel PORTOFINO 2 (noce) in acciaio con verniciatura antigraffio	
90052	1 Base PORTOFINO con 2 ruote in gomma naturale Ø 150 mm c/freno (art. 90051) e 2 s/freno (art. 90050)	
90056	2 Spalle hotel noce	
90090	2 Set reggisacco e portasacco reclinabili con paracolpi, completi di piastre di fissaggio e sacco cotone sanforizzato 120 lt	
90057	1 Schienale PORTOFINO	
90054	1 Asta di fissaggio PORTOFINO	
GR90058	1 Asta di fissaggio con inserto per PORTOFINO	
2025/M	1 Vassoio piccolo	
90053	3 Ripiani PORTOFINO	
KITCLASSIC/B	1 Kit montaggio PORTOFINO/AMALFI/VENEZIA 2	

Da 8 a 12 camere

 90x57x130h cm



1 Pz/2 cartoni 50 Kg 0,260 m³



154x57x131h cm
(65x57x150h cm)



1 Pz/2 cartoni 53 Kg 0,260 m³



Codice	Descrizione	Colore
90007	Carrello hotel AMALFI 1 (noce) in acciaio con verniciatura antigraffio	
90071	1 Base AMALFI con 2 ruote in gomma naturale Ø 150 mm c/freno (art. 90051) e 2 s/freno (art. 90050)	
90056	2 Spalle hotel noce	
GR7043/V	1 Reggisacco mobile hotel con anello in gomma	
90090	1 Set reggisacco e portasacco reclinabili con paracolpi, completo di piastre di fissaggio e sacco cotone sanforizzato 120 lt	
90095	1 Asta di fissaggio con cave per AMALFI	●
GR90094	1 Asta di fissaggio con inserti per AMALFI	●
2024/M	1 Vassoio mini	
2025/M	1 Vassoio piccolo	
90091	3 Ripiani AMALFI	
90093	1 Coppia pannelli per schienale AMALFI	
KITCLASSIC/A	1 Kit montaggio PORTOFINO/AMALFI/VENEZIA 1	

Da 12 a 15 camere

Codice	Descrizione	Colore
90009	Carrello hotel AMALFI 2 (noce) in acciaio con verniciatura antigraffio	
90071	1 Base AMALFI con 2 ruote in gomma naturale Ø 150 mm c/freno (art. 90051) e 2 s/freno (art. 90050)	
90056	2 Spalle hotel noce	
90090	2 Set reggisacco e portasacco reclinabili con paracolpi, completi di piastre di fissaggio e sacco cotone sanforizzato 120 lt	
2024/M	1 Vassoio mini	●
2025/M	1 Vassoio piccolo	●
90091	3 Ripiani AMALFI	
90093	1 Coppia pannelli per schienale AMALFI	
KITCLASSIC/B	1 Kit montaggio PORTOFINO/AMALFI/VENEZIA 2	

Da 12 a 15 camere

115x57x130h cm | 1 Pz/2 cartoni 58 Kg 0,260 m³

174x57x131h cm (85x57x150h cm) | 1 Pz/2 cartoni 61 Kg 0,260 m³



Codice	Descrizione	Colore
90011	Carrello hotel VENEZIA 1 (noce) in acciaio con verniciatura antigraffio	
90100	1 Base VENEZIA con 2 ruote in gomma naturale Ø 150 mm c/freno (art. 90051) e 2 s/freno (art. 90050)	
90056	2 Spalle hotel noce	
GR7043/V	1 Reggisacco mobile hotel con anello in gomma	
90090	1 Set reggisacco e portasacco reclinabili con paracolpi, completo di piastre di fissaggio e sacco cotone sanforizzato 120 lt	
90108	1 Asta di fissaggio con cave per VENEZIA	
GR90107	1 Asta di fissaggio con inserti per VENEZIA	
2025/M	2 Vassoi piccoli	●
90102	3 Ripiani VENEZIA	
90106	6 Profili per ripiani VENEZIA	
90109	1 Coppia pannelli per schienale VENEZIA	
KITCLASSIC/A	1 Kit montaggio PORTOFINO/AMALFI/VENEZIA 1	

Da 15 a 18 camere

 145x57x130h cm



1 Pz/2 cartoni 65 Kg 0,260 m³



Codice	Descrizione	Colore
90013	Carrello hotel VENEZIA 2 (noce) in acciaio con verniciatura antigraffio	
90100	1 Base VENEZIA con 2 ruote in gomma naturale Ø 150 mm c/freno (art. 90051) e 2 s/freno (art. 90050)	
90056	2 Spalle hotel noce	
90090	2 Set reggisacco e portasacco reclinabili con paracolpi, completi di piastre di fissaggio e sacco cotone sanforizzato 120 lt	
90108	1 Asta di fissaggio con cave per VENEZIA	
GR90107	1 Asta di fissaggio con inserti per VENEZIA	
2025/M	2 Vassoi piccoli	●
90106	6 Profili per ripiani VENEZIA	
90109	1 Coppia pannelli per schienale VENEZIA	
KITCLASSIC/B	1 Kit montaggio PORTOFINO/AMALFI/VENEZIA 2	

Da 15 a 18 camere

 194x57x131h cm
(105x57x150h cm)



1 Pz/2 cartoni 68 Kg 0,260 m³



Codice	Descrizione	Colore
--------	-------------	--------

90020	Carrello hotel AMALFI ELEGANCE 1 (noce) in acciaio con verniciatura antigraffio	
90071	1 Base AMALFI con 2 ruote in gomma naturale Ø 150 mm c/freno (art. 90051) e 2 s/freno (art. 90050)	
90056	2 Spalle hotel noce	
GR7043/V	1 Reggisacco mobile hotel con anello in gomma	
90090	1 Set reggisacco e portasacco reclinabili con paracolpi, completo di piastre di fissaggio e sacco cotone sanforizzato 120 lt	
GR90094	1 Asta di fissaggio con inserti per AMALFI	
90095	1 Asta di fissaggio con cave per AMALFI	
2024/M	1 Vassoio mini	●
2025/M	1 Vassoio piccolo	●
90091	4 Ripiani AMALFI	
90093	1 Coppia pannelli per schienale AMALFI	
90150/N	1 Coppia pannelli per antine AMALFI ELEGANCE	
KITELEGANCE/A	1 Kit montaggio ELEGANCE/CATERING 1	
KITELEGANCE/C	1 Kit montaggio sportelli con serratura ELEGANCE	

Da 8 a 15 camere

Codice	Descrizione	Colore
--------	-------------	--------

90022	Carrello hotel AMALFI ELEGANCE 2 (noce) in acciaio con verniciatura antigraffio	
90071	1 Base AMALFI con 2 ruote in gomma naturale Ø 150 mm c/freno (art. 90051) e 2 s/freno (art. 90050)	
90056	2 Spalle hotel noce	
90090	2 Set reggisacco e portasacco reclinabili con paracolpi, completi di piastre di fissaggio e sacco cotone sanforizzato 120 lt	
GR90094	1 Asta di fissaggio con inserti per AMALFI	
90095	1 Asta di fissaggio con cave per AMALFI	
2024/M	1 Vassoio mini	●
2025/M	1 Vassoio piccolo	●
90091	4 Ripiani AMALFI	
90093	1 Coppia pannelli per schienale AMALFI	
90150/N	1 Coppia pannelli per antine AMALFI ELEGANCE	
KITELEGANCE/B	1 Kit montaggio ELEGANCE/CATERING 2	
KITELEGANCE/C	1 Kit montaggio sportelli con serratura ELEGANCE	

Da 8 a 15 camere

115x57x130h cm | 1 Pz/2 cartoni 63,5 Kg 0,260 m³

150x57x130h cm | 1 Pz/2 cartoni 67 Kg 0,260 m³



Codice	Descrizione	Colore
90028	Carrello hotel AMALFI CATERING (noce) in acciaio con verniciatura antigraffio (adatto al rifornimento frigobar)	
90071	1 Base AMALFI con 2 ruote in gomma naturale Ø 150 mm c/freno (art. 90051) e 2 s/freno (art. 90050)	
90056	2 Spalle hotel noce	
90125	1 Set completo di 2 maniglie di spinta con paracolpi e piastre di fissaggio per AMALFI/VENEZIA CATERING	
GR90094	1 Asta di fissaggio con inserti per AMALFI	
90095	1 Asta di fissaggio con cave per AMALFI	●
2024/M	1 Vassoio mini	●
2025/M	1 Vassoio piccolo	
90091	4 Ripiani AMALFI	
90093	1 Coppia pannelli per schienale AMALFI	
90150/N	1 Coppia pannelli per antine AMALFI ELEGANCE	
KITCATERING	1 Kit montaggio CATERING/BAG	
KITELEGANCE/C	1 Kit montaggio sportelli con serratura ELEGANCE	



Codice	Descrizione	Colore
90024	Carrello hotel VENEZIA ELEGANCE 1 (noce) in acciaio con verniciatura antigraffio	
90100	1 Base VENEZIA con 2 ruote in gomma naturale Ø 150 mm c/freno (art. 90051) e 2 s/freno (art. 90050)	
90056	2 Spalle hotel noce	
GR7043/V	1 Reggisacco mobile hotel con anello in gomma	
90090	1 Set reggisacco e portasacco reclinabili con paracolpi, completo di piastre di fissaggio e sacco cotone sanforizzato 120 lt	
2025/M	2 Vassoi piccoli	●
GR90107	1 Asta di fissaggio con inserti per VENEZIA	
90108	1 Asta di fissaggio con cave per VENEZIA	
90102	4 Ripiani VENEZIA	
90106	8 Profili per ripiani VENEZIA	
90109	1 Coppia pannelli per schienale VENEZIA	
90152/N	1 Coppia pannelli per antine VENEZIA ELEGANCE	
KITELEGANCE/A	1 Kit montaggio ELEGANCE/CATERING 1	
KITELEGANCE/C	1 Kit montaggio sportelli con serratura ELEGANCE	

Da 15 a 18 camere

 **121x57x131h cm**
(85x57x131h cm) |  **1 Pz/2 cartoni 61 Kg 0,260 m³**

 **145x57x130h cm** |  **1 Pz/2 cartoni 69 Kg 0,260 m³**



Codice	Descrizione	Colore
90026	Carrello hotel VENEZIA ELEGANCE 2 (noce) in acciaio con verniciatura antigraffio	
90100	1 Base VENEZIA con 2 ruote in gomma naturale Ø 150 mm c/freno (art. 90051) e 2 s/freno (art. 90050)	
90056	2 Spalle hotel noce	
90090	2 Set reggisacco e portasacco reclinabili con paracolpi, completi di piastre di fissaggio e sacco cotone sanforizzato 120 lt	
2025/M	2 Vassoi piccoli	●
GR90107	1 Asta di fissaggio con inserti per VENEZIA	
90108	1 Asta di fissaggio con cave per VENEZIA	
90102	4 Ripiani VENEZIA	
90106	8 Profili per ripiani VENEZIA	
90109	1 Coppia pannelli per schienale VENEZIA	
90152/N	1 Coppia pannelli per antine VENEZIA ELEGANCE	
KITELEGANCE/B	1 Kit montaggio ELEGANCE/CATERING 2	
KITELEGANCE/C	1 Kit montaggio sportelli con serratura ELEGANCE	

Codice	Descrizione	Colore
90030	Carrello hotel VENEZIA CATERING (noce) in acciaio con verniciatura antigraffio (adatto al rifornimento frigobar)	
90100	1 Base VENEZIA con 2 ruote in gomma naturale Ø 150 mm c/freno (art. 90051) e 2 s/freno (art. 90050)	
90056	2 Spalle hotel noce	
90125	1 Set completo di 2 maniglie di spinta con paracolpi e piastre di fissaggio per AMALFI/VENEZIA CATERING	●
2025/M	2 Vassoi piccoli	●
90108	1 Asta di fissaggio con cave per VENEZIA	
GR90107	1 Asta di fissaggio con inserti per VENEZIA	
90102	4 Ripiani VENEZIA	
90106	8 Profili per ripiani VENEZIA	
90109	1 Coppia pannelli per schienale VENEZIA	
90152/N	1 Coppia pannelli per antine VENEZIA ELEGANCE	
KITCATERING	1 Kit montaggio CATERING/BAG	
KITELEGANCE/C	1 Kit montaggio sportelli con serratura ELEGANCE	

Da 15 a 18 camere

190x57x130h cm | 1 Pz/2 cartoni 73 Kg 0,260 m³

141x57x131h cm (105x57x131h cm) | 1 Pz/2 cartoni 71 Kg 0,260 m³



Codice	Descrizione	Colore
90035	Carrello hotel AMALFI BAG in acciaio con verniciatura antigraffio	
90071/BAG	1 Base AMALFI BAG con 2 ruote in gomma naturale Ø 150 mm c/freno (art. 90051) e 2 s/freno (art. 90050)	
90240/BAG	2 Spalle BAG complete di traverse	
90244	1 Traversa media per AMALFI BAG	
KITCATERING	1 Kit montaggio CATERING/BAG	

Capacità valigie: 6-8
Peso a vuoto: 26 Kg



Codice	Descrizione	Colore
90036	Carrello hotel VENEZIA BAG in acciaio con verniciatura antigraffio	
90100/BAG	1 Base VENEZIA BAG con 2 ruote in gomma naturale Ø 150 mm c/freno (art. 90051) e 2 s/freno (art. 90050)	
90240/BAG	2 Spalle BAG complete di traverse	
90245	1 Traversa lunga per VENEZIA BAG	
KITCATERING	1 Kit montaggio CATERING/BAG	









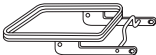

Capacità valigie: 8-10
Peso a vuoto: 28 Kg

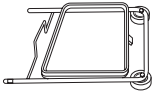
85x57x187h cm | **1 Pz/2 cartoni** **30 Kg** **0,220 m³**

105x57x187h cm | **1 Pz/2 cartoni** **32 Kg** **0,220 m³**

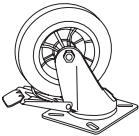

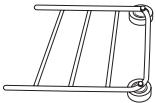
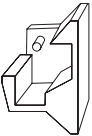
Codice	Descrizione	Colore
90061 SET	Set completo portaborse	
GR90061	1 Portasacco hotel con paracolpi	
KIT90065	1 Set completo piastre alluminio per HOTEL CLASSIC	

Codice	Descrizione	Colore	Codice	Descrizione	Colore	
	GR7043/V	Reggisacco mobile HOTEL con anello in gomma		2024/M	Vassoio mini	●
	GR90060	Reggisacco HOTEL con gomma e paracolpi		2025/M	Vassoio piccolo	●
	7031	Coperchio rettangolare		90050	Ruota in gomma naturale Ø 150 mm s/freno - att. piastra per base HOTEL	●
	7031 M	Coperchio EF/HO		90051	Ruota in gomma naturale Ø 150 mm c/freno - att. piastra per base HOTEL	●
	1622	Anello in gomma grande				
	2710	Cursore compl. per reggisacco rett. (con 2 clip art. 1701)				● ●
	GR90061	Portasacco HOTEL con paracolpi				
	KIT90065	Set completo piastre alluminio per HOTEL CLASSIC				
	1680	Sacco cotone sanforizzato 120 lt				





Codice	Descrizione	Colore
80001	Carrello hotel CAPRI 1	
80025IDEA/BASE	1 Base maxi IDEA completa di 2 ruote c/freno (art. 80061) e 2 s/freno (art. 80060) Ø 125 mm	●
21003 B	2 Finalini per base	●
80051	2 Spalle alte per CAPRI/ISCHIA/LINOSA	
80055	1 Reggisacco reclinabile per CAPRI/ISCHIA/LINOSA	
80030	1 Sacco nylon 150 lt - bordato blu per CAPRI/ISCHIA/LINOSA	
80045	3 Ripiani per CAPRI/ISCHIA	●
GR80046	1 Cassetto hotel con serratura	
GR80052/SET	1 Set 6 traverse corte CAPRI	
KITINNOVATIVE/A	1 Kit montaggio 80001	

Da 8 a 10 camere



Codice	Descrizione	Colore
80001/C	Carrello hotel CAPRI 1C (chiuso)	
80025IDEA/BASE	1 Base maxi IDEA completa di 2 ruote c/freno (art. 80061) e 2 s/freno (art. 80060) Ø 125 mm	●
21003 B	2 Finalini per base	●
80051	2 Spalle alte per CAPRI/ISCHIA/LINOSA	
80055	1 Reggisacco reclinabile per CAPRI/ISCHIA/LINOSA	
80030	1 Sacco nylon 150 lt - bordato blu per CAPRI/ISCHIA/LINOSA	
80045	3 Ripiani per CAPRI/ISCHIA	●
GR80046	1 Cassetto hotel con serratura	
80032	1 Carenatura nylon 3 lati per CAPRI	
GR80052/SET	1 Set 6 traverse corte CAPRI	
KITINNOVATIVE/A	1 Kit montaggio 80001	

Da 8 a 10 camere

110x55x152h cm | 1 Pz/2 cartoni 20 Kg 0,300 m³

110x55x152h cm | 1 Pz/2 cartoni 23,5 Kg 0,300 m³



Codice Descrizione Colore

80002	Carrello hotel CAPRI 2	
80025IDEA/BASE	1 Base maxi IDEA completa di 2 ruote c/freno (art. 80061) e 2 s/freno (art. 80060) Ø 125 mm	●
21003 B	2 Finalini per base	●
80051	2 Spalle alte per CAPRI/ISCHIA/LINOSA	
80055	2 Reggisacco reclinabili per CAPRI/ISCHIA/LINOSA	
80030	2 Sacchi nylon 150 lt - bordato blu per CAPRI/ISCHIA/LINOSA	
80045	3 Ripiani per CAPRI/ISCHIA	●
GR80046	1 Cassetto hotel con serratura	
GR80052/SET	1 Set 6 traverse corte CAPRI	
KITINNOVATIVE/B	1 Kit montaggio 80002	

Da 8 a 12 camere

Codice Descrizione Colore

80002/C	Carrello hotel CAPRI 2C (chiuso)	
80025IDEA/BASE	1 Base maxi IDEA completa di 2 ruote c/freno (art. 80061) e 2 s/freno (art. 80060) Ø 125 mm	●
21003 B	2 Finalini per base	●
80051	2 Spalle alte per CAPRI/ISCHIA/LINOSA	
80055	2 Reggisacco reclinabili per CAPRI/ISCHIA/LINOSA	
80030	2 Sacchi nylon 150 lt - bordato blu per CAPRI/ISCHIA/LINOSA	
80045	3 Ripiani per CAPRI/ISCHIA	●
GR80046	1 Cassetto hotel con serratura	
80032	1 Carenatura nylon 3 lati per CAPRI	
GR80052/SET	1 Set 6 traverse corte CAPRI	
KITINNOVATIVE/B	1 Kit montaggio 80002	

Da 8 a 12 camere

 150/110x55x152h cm |  1 Pz/2 cartoni 22 Kg 0,300 m³

 150/110x55x152h cm |  1 Pz/2 cartoni 25,5 Kg 0,300 m³



Codice	Descrizione	Colore
80003	Carrello hotel CAPRI 3	
80025IDEA/BASE	1 Base maxi IDEA completa di 2 ruote c/freno (art. 80061) e 2 s/freno (art. 80060) Ø 125 mm	●
80043IDEA/BASE	1 Prolunga per base maxi con 1 ruota Ø 125 mm s/freno (art. 80060)	●
21003 B	1 Finalino per base	●
80051	2 Spalle alte per CAPRI/ISCHIA/LINOSA	●
80055	2 Reggisacco reclinabili per CAPRI/ISCHIA/LINOSA	●
80030	2 Sacchi nylon 150 lt - bordati blu per CAPRI/ISCHIA/LINOSA	●
80045	3 Ripiani per CAPRI/ISCHIA	●
GR80046	1 Cassetto hotel con serratura	●
GR80052/SET	1 Set 6 traverse corte CAPRI	
KITINNOVATIVE/C	1 Kit montaggio 80003	

Da 8 a 12 camere

140x55x152h cm



1 Pz/2 cartoni

24 Kg

0,300 m³



Codice	Descrizione	Colore
80003/C	Carrello hotel CAPRI 3C (chiuso)	
80025IDEA/BASE	1 Base maxi IDEA completa di 2 ruote c/freno (art. 80061) e 2 s/freno (art. 80060) Ø 125 mm	●
80043IDEA/BASE	1 Prolunga per base maxi con 1 ruota Ø 125 mm s/freno (art. 80060)	●
21003 B	1 Finalino per base	●
80051	2 Spalle alte per CAPRI/ISCHIA/LINOSA	●
80055	2 Reggisacco reclinabili per CAPRI/ISCHIA/LINOSA	●
80030	2 Sacchi nylon 150 lt - bordati blu per CAPRI/ISCHIA/LINOSA	●
80045	3 Ripiani per CAPRI/ISCHIA	●
GR80046	1 Cassetto hotel con serratura	●
80032	1 Carenatura nylon 3 lati per CAPRI	
GR80052/SET	1 Set 6 traverse corte CAPRI	
KITINNOVATIVE/C	1 Kit montaggio 80003	

Da 8 a 12 camere

140x55x152h cm



1 Pz/2 cartoni

28 Kg

0,300 m³



Codice Descrizione Colore

80004	Carrello hotel CAPRI 4	
80025IDEA/BASE	1 Base maxi IDEA completa di 2 ruote c/freno (art. 80061) e 2 s/freno (art. 80060) Ø 125 mm	●
21003 B	2 Finalini per base	●
80051	2 Spalle alte per CAPRI/ISCHIA/LINOSA	
80055	1 Reggisacco reclinabile per CAPRI/ISCHIA/LINOSA	
80030	1 Sacco nylon 150 lt - bordato blu per CAPRI/ISCHIA/LINOSA	
80045	3 Ripiani per CAPRI/ISCHIA	●
GR80046	1 Cassetto hotel con serratura	
80032	1 Carenatura nylon 3 lati per CAPRI	
2723	1 Cestello portaflaconi	
21005 B	1 Secchio 15 lt IDEA	●
21005 R	1 Secchio 15 lt IDEA	●
GR21020	1 Portapressa in rilsan IDEABASE	
3501 VDM	1 Strizzatore a rullo ELPAROLL	
GR80052/SET	1 Set 6 traverse corte CAPRI	
KITINNOVATIVE/D	1 Kit montaggio 80004 con 2 portamanico (art. 2255)	

Da 8 a 12 camere

Codice Descrizione Colore

80005	Carrello hotel CAPRI 5	
80025IDEA/BASE	1 Base maxi IDEA completa di 2 ruote c/freno (art. 80061) e 2 s/freno (art. 80060) Ø 125 mm	●
21003 B	2 Finalini per base	●
80051	2 Spalle alte per CAPRI/ISCHIA/LINOSA	
80055	1 Reggisacco reclinabile per CAPRI/ISCHIA/LINOSA	
80030	1 Sacco nylon 150 lt - bordato blu per CAPRI/ISCHIA/LINOSA	
80045	3 Ripiani per CAPRI/ISCHIA	●
GR80046	1 Cassetto hotel con serratura	
80032	1 Carenatura nylon 3 lati per CAPRI	
2723	1 Cestello portaflaconi	
2270 R	1 Secchio rett. 13 lt	●
7030 B	1 Secchio rett. 22 lt	●
80056	1 Borsa nylon per secchio 13 lt per CAPRI/ISCHIA	
7032	1 Griglia inox pieghevole (per secchio rett. 22 lt)	
GR80052/SET	1 Set 6 traverse corte CAPRI	
KITINNOVATIVE/E	1 Kit montaggio 80005-80006 con 2 portamanico (art. 2255)	

Da 8 a 12 camere

150/110x55x152h cm | 1 Pz/2 cartoni 33 Kg 0,300 m³

150/110x55x152h cm | 1 Pz/2 cartoni 29 Kg 0,300 m³



Codice	Descrizione	Colore
80006	Carrello hotel CAPRI 6	
80025IDEA/BASE	1 Base maxi IDEA completa di 2 ruote c/freno (art. 80061) e 2 s/freno (art. 80060) Ø 125 mm	●
21003 B	2 Finalini per base	●
80051	2 Spalle alte per CAPRI/ISCHIA/LINOSA	
80055	1 Reggisacco reclinabile per CAPRI/ISCHIA/LINOSA	
80030	1 Sacco nylon 150 lt - bordato blu per CAPRI/ISCHIA/LINOSA	
80045	3 Ripiani per CAPRI/ISCHIA	●
GR80046	1 Cassetto hotel con serratura	
80032	1 Carenatura nylon 3 lati per CAPRI	
2723	1 Cestello portaflaconi	
2270 R	1 Secchio rett. 13 lt	●
7030 B	1 Secchio rett. 22 lt	●
80056	1 Borsa nylon per secchio 13 lt per CAPRI/ISCHIA	
7038	1 Coperchio per secchio rett. 22 lt	●
GR80052/SET	1 Set 6 traverse corte CAPRI	
KITINNOVATIVE/E	1 Kit montaggio 80005-80006 con 2 portamanico (art. 2255)	

Da 8 a 12 camere



Codice	Descrizione	Colore
80007	Carrello hotel CAPRI 7	
80025IDEA/BASE	1 Base maxi IDEA completa di 2 ruote c/freno (art. 80061) e 2 s/freno (art. 80060) Ø 125 mm	●
21003 B	2 Finalini per base	●
GR21016/CAPRI	1 Spalla diritta in rilsan IDEABASE con reggisacco con anello in gomma e portasecchio 22 lt	
80051	2 Spalle alte per CAPRI/ISCHIA/LINOSA	
80055	1 Reggisacco reclinabile per CAPRI/ISCHIA/LINOSA	
7031 BSV	1 Coperchio rettangolare	●
80030	1 Sacco nylon 150 lt - bordato blu per CAPRI/ISCHIA/LINOSA	
80045	3 Ripiani per CAPRI/ISCHIA	●
GR80046	1 Cassetto hotel con serratura	
80032	1 Carenatura nylon 3 lati per CAPRI	
24053	1 Cestello portaoggetti IDEA	●
7030 B	1 Secchio rett. 22 lt	●
7038	1 Coperchio per secchio rett. 22 lt	●
GR80052/SET	1 Set 6 traverse corte CAPRI	
KITINNOVATIVE/F	1 Kit montaggio 80007 con 2 portamanico (art. 2255)	

Da 8 a 12 camere

150/110x55x152cm | 1 Pz/2 cartoni 28 Kg 0,300 m³

160/110x55x152cm | 1 Pz/2 cartoni 32 Kg 0,300 m³



Codice	Descrizione	Colore
--------	-------------	--------

80011	Carrello hotel ISCHIA 11	
80025IDEA/BASE	1 Base maxi IDEA completa di 2 ruote c/freno (art. 80061) e 2 s/freno (art. 80060) Ø 125 mm	●
21003 B	2 Finalini per base	●
80051	2 Spalle alte per CAPRI/ISCHIA/LINOSA	
80055	1 Reggisacco reclinabile per CAPRI/ISCHIA/LINOSA	
80030	1 Sacco nylon 150 lt - bordato blu per CAPRI/ISCHIA/LINOSA	
80045	6 Ripiani per CAPRI/ISCHIA	●
GR80046	2 Cassetti hotel con serratura	
GR80053/SET	1 Set 6 traverse lunghe ISCHIA	
KITINNOVATIVE/G	1 Kit montaggio 80011	

Da 12 a 15 camere

Codice	Descrizione	Colore
--------	-------------	--------

80011/C	Carrello hotel ISCHIA 11C (chiuso)	
80025IDEA/BASE	1 Base maxi IDEA completa di 2 ruote c/freno (art. 80061) e 2 s/freno (art. 80060) Ø 125 mm	●
21003 B	2 Finalini per base	●
80051	2 Spalle alte per CAPRI/ISCHIA/LINOSA	
80055	1 Reggisacco reclinabile per CAPRI/ISCHIA/LINOSA	
80030	1 Sacco nylon 150 lt - bordato blu per CAPRI/ISCHIA/LINOSA	
80045	6 Ripiani per CAPRI/ISCHIA	●
GR80046	2 Cassetti hotel con serratura	
80034	1 Carenatura nylon 3 lati per ISCHIA	
GR80053/SET	1 Set 6 traverse lunghe ISCHIA	
KITINNOVATIVE/G	1 Kit montaggio 80011	

Da 12 a 15 camere

 150/110x55x152hcm |  1 Pz/2 cartoni 25 Kg 0,300 m³

 150/110x55x152hcm |  1 Pz/2 cartoni 29,5 Kg 0,300 m³



Codice	Descrizione	Colore
80012	Carrello hotel ISCHIA 12	
80025IDEA/BASE	1 Base maxi IDEA completa di 2 ruote c/freno (art. 80061) e 2 s/freno (art. 80060) Ø 125 mm	●
21003 B	2 Finalini per base	●
80051	2 Spalle alte per CAPRI/ISCHIA/LINOSA	
80055	2 Reggisacco reclinabili per CAPRI/ISCHIA/LINOSA	
80030	2 Sacchi nylon 150 lt - bordati blu per CAPRI/ISCHIA/LINOSA	
80045	6 Ripiani per CAPRI/ISCHIA	●
GR80046	2 Cassetti hotel con serratura	
GR80053/SET	1 Set 6 traverse lunghe ISCHIA	
KITINNOVATIVE/H	1 Kit montaggio 80012	

Da 15 a 18 camere



Codice	Descrizione	Colore
80012/C	Carrello hotel ISCHIA 12C (chiuso)	
80025IDEA/BASE	1 Base maxi IDEA completa di 2 ruote c/freno (art. 80061) e 2 s/freno (art. 80060) Ø 125 mm	●
21003 B	2 Finalini per base	●
80051	2 Spalle alte per CAPRI/ISCHIA/LINOSA	
80055	2 Reggisacco reclinabili per CAPRI/ISCHIA/LINOSA	
80030	2 Sacchi nylon 150 lt - bordati blu per CAPRI/ISCHIA/LINOSA	
80045	6 Ripiani per CAPRI/ISCHIA	●
GR80046	2 Cassetti hotel con serratura	
80034	1 Carenatura nylon 3 lati per ISCHIA	
GR80053/SET	1 Set 6 traverse lunghe ISCHIA	
KITINNOVATIVE/H	1 Kit montaggio 80012	

Da 15 a 18 camere

 190/110x55x152hcm |  1 Pz/2 cartoni 26 Kg 0,300 m³

 190/110x55x152hcm |  1 Pz/2 cartoni 30 Kg 0,300 m³



Codice	Descrizione	Colore
80013	Carrello hotel ISCHIA 13	
80025IDEA/BASE	1 Base maxi IDEA completa di 2 ruote c/freno (art. 80061) e 2 s/freno (art. 80060) Ø 125	●
80043IDEA/BASE	1 Prolunga per base maxi con 1 ruota Ø 125 mm s/freno (art. 80060)	●
21003 B	1 Finalino per base	●
80051	2 Spalle alte per CAPRI/ISCHIA/LINOSA	●
80055	2 Reggisacco reclinabili per CAPRI/ISCHIA/LINOSA	●
80030	2 Sacchi nylon 150 lt - bordati blu per CAPRI/ISCHIA/LINOSA	●
80045	6 Ripiani per CAPRI/ISCHIA	●
GR80046	2 Cassetti hotel con serratura	●
GR80053/SET	1 Set 6 traverse lunghe ISCHIA	●
KITINNOVATIVE/I	1 Kit montaggio 80013	●

Da 15 a 18 camere

Codice	Descrizione	Colore
80013/C	Carrello hotel ISCHIA 13C (chiuso)	
80025IDEA/BASE	1 Base maxi IDEA completa di 2 ruote c/freno (art. 80061) e 2 s/freno (art. 80060) Ø 125	●
80043IDEA/BASE	1 Prolunga per base maxi con 1 ruota Ø 125 mm s/freno (art. 80060)	●
21003 B	1 Finalino per base	●
80051	2 Spalle alte per CAPRI/ISCHIA/LINOSA	●
80055	2 Reggisacco reclinabili per CAPRI/ISCHIA/LINOSA	●
80030	2 Sacchi nylon 150 lt - bordati blu per CAPRI/ISCHIA/LINOSA	●
80045	6 Ripiani per CAPRI/ISCHIA	●
GR80046	2 Cassetti hotel con serratura	●
80034	1 Carenatura nylon 3 lati per ISCHIA	●
GR80053/SET	1 Set 6 traverse lunghe ISCHIA	●
KITINNOVATIVE/I	1 Kit montaggio 80013	●

Da 15 a 18 camere

 190/150x55x152h cm |  1 Pz/2 cartoni 28 Kg 0,300 m³

 190/150x55x152h cm |  1 Pz/2 cartoni 32,5 Kg 0,300 m³



Codice	Descrizione	Colore
80015	Carrello hotel ISCHIA 15	
80025IDEA/BASE	1 Base maxi IDEA completa di 2 ruote c/freno (art. 80061) e 2 s/freno (art. 80060) Ø 125 mm	●
80043IDEA/BASE	2 Prolunghe per base maxi con 1 ruota Ø 125 mm s/freno (art. 80060)	●
80051	2 Spalle alte per CAPRI/ISCHIA/LINOSA	
80055	2 Reggisacco reclinabili per CAPRI/ISCHIA/LINOSA	
80030	2 Sacchi nylon 150 lt - bordati blu per CAPRI/ISCHIA/LINOSA	
80045	6 Ripiani per CAPRI/ISCHIA	●
GR80046	2 Cassetti hotel con serratura	
GR80053/SET	1 Set 6 traverse lunghe ISCHIA	
KITINNOVATIVE/J	1 Kit montaggio 80015	

Da 15 a 18 camere

190x55x152h cm | 1 Pz/2 cartoni 32 Kg 0,300 m³



Codice	Descrizione	Colore
80015/C	Carrello hotel ISCHIA 15C (chiuso)	
80025IDEA/BASE	1 Base maxi IDEA completa di 2 ruote c/freno (art. 80061) e 2 s/freno (art. 80060) Ø 125 mm	●
80043IDEA/BASE	2 Prolunghe per base maxi con 1 ruota Ø 125 mm s/freno (art. 80060)	●
80051	2 Spalle alte per CAPRI/ISCHIA/LINOSA	
80055	2 Reggisacco reclinabili per CAPRI/ISCHIA/LINOSA	
80030	2 Sacchi nylon 150 lt - bordati blu per CAPRI/ISCHIA/LINOSA	
80045	6 Ripiani per CAPRI/ISCHIA	●
GR80046	2 Cassetti hotel con serratura	
80034	1 Carenatura nylon 3 lati per ISCHIA	
GR80053/SET	1 Set 6 traverse lunghe ISCHIA	
KITINNOVATIVE/J	1 Kit montaggio 80015	

Da 15 a 18 camere

190x55x152h cm | 1 Pz/2 cartoni 36 Kg 0,300 m³



Codice	Descrizione	Colore
--------	-------------	--------

80016	Carrello portabiancheria LINOSA 1	
80025IDEA/LINOSA	1 Base maxi IDEA completa di 4 ruote Ø 125 mm s/freno (art. 80060)	●
21003 B	2 Finalini per base	●
80048	2 Spalle basse per LINOSA	
80035	1 Sacco nylon 300 lt per LINOSA 1	
80053	2 Traverse lunghe per ISCHIA/LINOSA	
KITINNOVATIVE/K	1 Kit montaggio 80016	

Codice	Descrizione	Colore
--------	-------------	--------

80018	Carrello hotel LINOSA 2	
80025IDEA/BASE	1 Base maxi IDEA completa di 2 ruote c/freno (art. 80061) e 2 s/freno (art. 80060) Ø 125 mm	●
21003 B	2 Finalini per base	●
80051	2 Spalle alte per CAPRI/ISCHIA/LINOSA	
80030	2 Sacchi nylon 150 lt - bordati blu per CAPRI/ISCHIA/LINOSA	
80053	2 Traverse lunghe per ISCHIA/LINOSA	
KITINNOVATIVE/L	1 Kit montaggio 80018	

 **110x55x113h cm** |  **2 Pz/cartone** **28,5 Kg** **0,290 m³**

 **110x55x152h cm** |  **1 Pz/cartone** **16 Kg** **0,260 m³**



Codice	Descrizione	Colore
--------	-------------	--------

80019 Carrello hotel LINOSA 3

80025IDEA/BASE	1 Base maxi IDEA completa di 2 ruote c/freno (art. 80061) e 2 s/freno (art. 80060) Ø 125 mm	●
21003 B	2 Finalini per base	●
80051	2 Spalle alte per CAPRI/ISCHIA/LINOSA	
80055	1 Reggisacco reclinabile per CAPRI/ISCHIA/LINOSA	
80030	3 Sacchi nylon 150 lt - bordati blu per CAPRI/ISCHIA/LINOSA	
80053	2 Traverse lunghe per ISCHIA/LINOSA	
KITINNOVATIVE/M	1 Kit montaggio 80019	









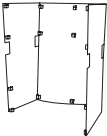
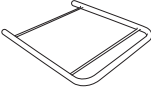
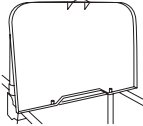

Codice	Descrizione	Colore
--------	-------------	--------

80020 Carrello hotel LINOSA 4

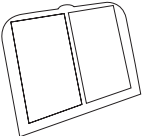
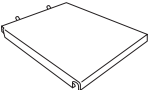
80025IDEA/BASE	1 Base maxi IDEA completa di 2 ruote c/freno (art. 80061) e 2 s/freno (art. 80060) Ø 125 mm	●
80043IDEA/BASE	1 Prolunga per base maxi con 1 ruota Ø 125 mm s/freno (art. 80060)	●
21003 B	1 Finalino per base	●
80051	2 Spalle alte per CAPRI/ISCHIA/LINOSA	
80055	1 Reggisacco reclinabile per CAPRI/ISCHIA/LINOSA	
GR80066	1 Reggisacco CAPRI/ISCHIA/LINOSA con anello in gomma	
7031 BSV	1 Coperchio rettangolare	●
80030	3 Sacchi nylon 150 lt - bordati blu per CAPRI/ISCHIA/LINOSA	
80053	2 Traverse lunghe per ISCHIA/LINOSA	
KITINNOVATIVE/N	1 Kit montaggio 80020	

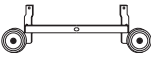
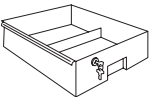
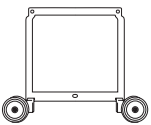
140/110x55x152h cm | 1 Pz/2 cartoni 18,5 Kg 0,260 m³

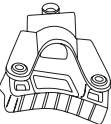
190/140x55x152h cm | 1 Pz/2 cartoni 22 Kg 0,260 m³

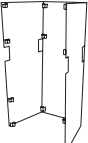
Codice	Descrizione	Colore	Codice	Descrizione	Colore
 GR80066	Reggisacco CAPRI/ISCHIA/LINOSA con anello in gomma		 80034	Carenatura nylon 3 lati per ISCHIA	
 80055	Reggisacco reclinabile per CAPRI/ISCHIA/LINOSA		 80038	Copertura frontale nylon per CAPRI	
 7031 BSV	Coperchio rettangolare	●	 80039	Copertura frontale nylon per ISCHIA	
 7031AZR	Coperchio rettangolare con leggio	●	 80045	Ripiano per CAPRI/ISCHIA	●
 1622	Anello in gomma grande		 80075	Tasca portaoggetti per CAPRI/ISCHIA/LINOSA	
 80071	Telaio paracolpi per base IDEA maxi		 GR80046	Cassetto HOTEL con serratura	
 80072	Telaio paracolpi per prolunga IDEA maxi		 80047/C	Coppia chiavi per CAPRI/ISCHIA	
 2255	Portamanico in gomma con aggancio Ø 22 mm		 2025 B	Vassoio piccolo	●
 80032	Carenatura nylon 3 lati per CAPRI		 2270 R	Secchio rett. 13 lt	●

	Codice	Descrizione	Colore		Codice	Descrizione	Colore
	21005 B 21005 R	Secchio 15 lt IDEA	● ●		80035	Sacco nylon 300 lt per LINOSA 1	
	7030 B	Secchio rett. 22 lt	●		80056	Borsa nylon per secchio 13 lt per CAPRI/ISCHIA	
	21065 KIT80040	Portasecchio 22 lt in rilsan per IDEABASE Kit di fissaggio per spalla rilsan (1x80040, 2x2701/R, 2x2726, 2x2730)			80060	Ruota Ø 125 mm s/freno att. piastra per base maxi	
	7038	Coperchio per secchio rett. 22 lt	●		80061	Ruota Ø 125 mm c/freno att. piastra per base maxi	
	7032	Griglia inox pieghevole (per secchio rett. 22 lt)			80062	Ruota in nylon per moquette Ø 125 mm s/freno - att. piastra per base IDEA maxi	
	24053	Cestello portaoggetti IDEA	●		80065	Ruota morbida per esterno Ø 150 mm s/freno - att. piastra per base maxi	
	2723	Cestello portafiaconi			KIT2701	Kit coppia piastre alluminio per BIOSTEEL	
	80030 80030 G 80030 R 80030 V	Sacco nylon 150 lt per CAPRI/ISCHIA/LINOSA (bordature colorate)	● ● ● ●		1648	Vite con aletta plastica 6x15	
	80031	Sacco nylon aperto per CAPRI/ISCHIA/LINOSA			21030 B	Tappo per base	●

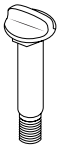
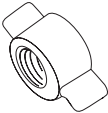
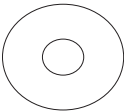
Codice	Descrizione	Colore
 21035 B	Perno filettato	
 21036	Ghiera filettata con alette	●
 4219	Rondella piana 6x24	



Codice	Descrizione	Colore
--------	-------------	--------

80022 Carrello hotel ELBA 1

GR2015	1 Base cromata 90x44 cm con 4 ruote Ø 100 mm (art. 2030) e paracolpi	
GR1625	2 Spalle multiuso con reggisacco e anello in gomma	
1610	1 Coperchio quadrato	●
1680	1 Sacco in cotone sanforizzato 120 lt	
2020	3 Ripiani per vassoi piccoli	
KITMULTIUSO/H	1 Kit montaggio ELBA 1-2-3	



Codice	Descrizione	Colore
--------	-------------	--------

80023 Carrello hotel ELBA 2

GR2015	1 Base cromata 90x44 cm con 4 ruote Ø 100 mm (art. 2030) e paracolpi	
GR1625	2 Spalle multiuso con reggisacco e anello in gomma	
1610	1 Coperchio quadrato	●
2225	1 Portasacco multiuso	
1680	1 Sacco in cotone sanforizzato 120 lt	
2220	3 Ripiani per vassoi grandi	
KITMULTIUSO/H	1 Kit montaggio ELBA 1-2-3	

 125x44x105h cm |  1 Pz/cartone 17 Kg 0,150 m³

 140x44x105h cm |  1 Pz/cartone 19 Kg 0,150 m³



Codice	Descrizione	Colore
--------	-------------	--------

80024	Carrello hotel ELBA 3	
GR2415	1 Base cromata 100x44 cm con 4 ruote Ø 100 mm (art. 2030) e paracolpi	
GR1625	1 Spalla multiuso con reggisacco e anello in gomma	
GR1625/TOP	1 Spalla multiuso senza reggisacco	
1610	1 Coperchio quadrato	●
2225	1 Portasacco multiuso	
1680	1 Sacco in cotone sanforizzato 120 lt	
2020	3 Ripiani per vassoi piccoli	
KITMULTIUSO/H	1 Kit montaggio ELBA 1-2-3	











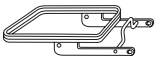

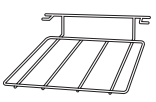
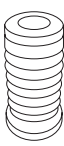

Codice	Descrizione	Colore
--------	-------------	--------

80017	Carrello hotel ELBA 4	
GR80017	1 Struttura ad X con 4 ruote Ø 80 mm (art. 1431) e paracolpi	
1680/G	1 Sacco in cotone sanforizzato 230 lt	

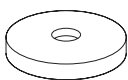
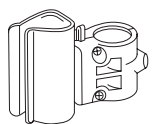
125x44x105hcm	1 Pz/cartone	18 Kg	0,150 m ³
---------------	--------------	-------	----------------------

53x50x104h cm	2 Pz/cartone	17 Kg	0,175 m ³
---------------	--------------	-------	----------------------

	Codice	Descrizione	Colore		Codice	Descrizione	Colore
	GR1620	Reggisacco multiuso con anello in gomma			2220	Ripiano per vassoio grande	
	1622	Anello in gomma grande			1431	Ruota ø 80 mm att. codulo e parafilo	
	1610	Coperchio quadrato	●		2030	Ruota ø 100 mm con filetto 8x28 e parafilo	
	2225	Portasacco multiuso			1432	Bussola per ruota con att. codulo (art. 1431)	
	1625	Spalla multiuso nuda			1031	Paracolpi piccolo	●
	KIT2230	Kit portamanico completo di aggancio ø 22 mm	●				
	1680	Sacco in cotone sanforizzato 120 lt					
	1680/G	Sacco in cotone sanforizzato 230 lt					
	2020	Ripiano per vassoio piccolo					

Condizioni di vendita

ORDINE

- Ogni ordine implica per l'acquirente l'accettazione delle nostre condizioni di vendita.
- Ogni ordine si intende accettato e confermato "salvo approvazione della casa". L'eventuale annullamento dello stesso può essere accettato solo se fatto entro le 24 ore successive.
- Tutti gli articoli sono venduti imballati e confezionati nelle quantità indicate sul listino prezzi.
- Nel caso le quantità ordinate non corrispondano, verranno automaticamente arrotondate alla confezione superiore.
- Valore minimo per fatturazione: €300,00.

PREZZI

- Tutti i prezzi unitari indicati sono espressi in EURO e sono da intendersi al netto di IVA e validi fino a nuova comunicazione di variazione (mediante preavviso di un mese).

CONSEGNA

- I termini di consegna concordati sono da considerarsi impegnativi. Eventuali ritardi causati da fatti non riconducibili alla nostra diretta responsabilità non possono dar luogo all'annullamento dell'ordine e/o penalità alcune.
- Per tutti gli ordini di valore superiore a €900,00 netto la consegna viene effettuata in porto franco su tutto il territorio italiano compresa la Sicilia. Sono escluse le altre isole e le cosiddette "zone disagiate" (zone montane) per le quali il valore dell'ordine dovrà essere concordato con la nostra forza vendita.
- Un importo forfettario di €40,00 viene richiesto per tutti gli ordini di valore netto tra €600,00 e €899,00.
- Un importo forfettario di €50,00 viene richiesto per tutti gli ordini di valore netto inferiore a €600,00.
- È fatto obbligo al destinatario di controllare la merce in arrivo e contestare subito eventuali danni o mancanze direttamente a Vettore o Conducente con l'apposizione di riserva scritta sul documento di trasporto.

VERSIONI SPECIALI

- Per carrelli richiesti con strizzatore diverso dallo standard, calcolare la differenza a valore pieno.
- Per carrelli richiesti con accessori diversi o sostitutivi di quelli standard, calcolare la differenza a valore pieno.
- Per carrelli richiesti in versione modificata o priva in tutto o in parte di accessori, chiedere il prezzo al ns. Ufficio Commerciale.

RESI

- In linea di principio, la merce inviata in conformità all'ordine non verrà ripresa né sostituita. Nessuna restituzione potrà aver luogo senza previa autorizzazione da parte della casa. In caso di autorizzazione la merce resa dovrà pervenire in porto franco, dovrà essere in condizioni impeccabili e confezionata nell'imballo originale. La nota credito relativa verrà emessa tenendo conto di eventuali perdite di valore.

PAGAMENTI

- I pagamenti dovranno essere effettuati in conformità alle relative indicazioni contenute nell'offerta di vendita o nella conferma d'ordine. In caso di ritardato pagamento verranno addebitati i relativi interessi moratori come da DL 192 del 9/11/2012. In caso di insoluti verranno addebitate le sole spese bancarie se il pagamento viene effettuato entro i primi 20 gg dalla scadenza. Al secondo insoluto verranno automaticamente modificate le condizioni di pagamento in contrassegno o anticipato.

IMMAGINI E DISEGNI

- Fotografie, disegni e quant'altro rappresentato nel presente listino sono di esclusiva proprietà di VDM Srl. E' perciò vietato disporre del loro utilizzo, in qualsiasi forma o mezzo senza la espressa autorizzazione scritta da parte di VDM Srl. Anche nel caso di diffusione autorizzata delle immagini dei nostri prodotti è fatto obbligo di indicare che si tratta di prodotti VDM Srl. Le immagini dei prodotti hanno carattere puramente illustrativo, la VDM Srl si riserva il diritto di apportare, anche senza preavviso, eventuali modifiche che, a suo insindacabile giudizio, si rendano necessari o utili.

RISERVA DI PROPRIETÀ

- La merce consegnata resta di proprietà della casa venditrice fino al pagamento totale della stessa da parte dell'acquirente. Quest'ultimo è autorizzato a rivendere la merce purché sia consapevole che la stessa è gravata da una clausola di riserva di proprietà e che il Venditore principale potrà reclamare il pagamento o la restituzione nel caso in cui l'importo della merce non sia stato corrisposto alla scadenza fissata.

FORO COMPETENTE

- Per ogni controversia di legge, il foro competente è quello di Milano.

Distributore:



VDM S.r.l. Viale delle Industrie 16/8 - 20020 Arese (MI) - ITALY

www.vdm.it