

NARDI
YOUR OUTDOOR LIVING

OUT
DO -
- OR

outdoor
design Raffaello Galotto

Design, relax all'aria aperta,
voglia di stare insieme e godere del tempo libero:
Nardi è ambasciatore nel mondo dell'outdoor Italian lifestyle.
Specialista di arredi per l'esterno,
da 30 anni progetta e realizza mobili in resina,
frutto di un'attenta ricerca all'insegna del design,
della qualità e della sostenibilità.

*Design, relaxation outdoors and a desire
to spend time together and enjoy your leisure time:
Nardi is an ambassador of Italian outdoor lifestyle across the globe.
A specialist in outdoor furniture,
for 30 years the company has been designing and producing resin furniture,
the outcome of meticulous research into design,
quality and sustainability.*

visione vision

Nardi è il risultato di una storia imprenditoriale che ha come cardini la cultura del progetto open air, l'attitudine all'innovazione e il design. L'azienda promuove l'incontro tra un disegno unico e la tecnologia più all'avanguardia, la qualità unita alla funzionalità e il pensiero ecologico che si realizza nella totale riciclabilità dei prodotti, nel riutilizzo degli scarti di produzione e nella progettazione di packaging eco-compatibili. Nardi distribuisce i suoi prodotti in tutto il mondo puntando a rendere unici ed accoglienti gli spazi esterni.

Nardi is the result of an entrepreneurial story, with its roots in the culture of open air projects and a talent for innovation and design. The company brings together unique designs and the most avant-garde technology, combining quality with functionality and an environmentally-friendly approach, with completely recyclable products, recycling of manufacturing waste and the design of eco-friendly packaging. Nardi distributes its products throughout the world, with the aim of making outdoor spaces unique and welcoming.

produzione *production*

Nardi realizza arredi per l'outdoor adatti ad ambienti home e collettivi, studiati per il benessere e il relax delle persone.

Il polipropilene fiber-glass di alta qualità è protagonista di tutte le collezioni che nascono da un'approfondita ricerca di design, colore e abbinamento di materiali. Ogni prodotto è realizzato in una filiera completamente Made in Italy e sottoposto a severi controlli di qualità. Ogni singola fase di processo è seguita da personale competente e valorizzato dall'azienda che pone al centro i rapporti con le persone.

Nardi produces outdoor furniture that is suitable for homes and communal areas, designed for people to relax and unwind. High quality, polypropylene fiberglass plays the leading role in every collection, all of which are created following extensive research into design, colour and the combination of materials. The company's production chain is entirely 'Made in Italy', with each product undergoing strict quality control checks. Every single phase of the production process is followed by expert members of staff and valued by the company, which considers solid relationships with its people as being a fundamental key to success.

index

10	<i>komodo modular system</i>
38	rio • trill • net
58	net collection
68	aria
76	alloro • palma
86	loto • ninfea
94	atlantico • pop
102	cube • erica
107	<i>schede tecniche/technical details</i>

Komodo *modular system*

Sistema di sedute imbottite modulari, componibili e configurabili a piacere. La struttura, ispirata ai rami degli alberi, connota l'arredo con carattere e accoglie soffici e colorati cuscini per creare la propria stanza a cielo aperto.

A modular upholstered seating system that can be arranged and configured as required. Its frame, inspired by tree branches, adds character to the furniture with soft colourful cushions to create your own open-air room.





KOMODO agave / avocado - giungla
KOMODO TAVOLINO agave



KOMODO POLTRONA agave / giungla



KOMODO POLTRONA agave / avocado



KOMODO agave / avocado - giungla
KOMODO TAVOLINO agave





KOMODO bianco / canvas
KOMODO TAVOLINO VETRO bianco / vetro



KOMODO bianco / canvas
KOMODO TAVOLINO VETRO bianco / vetro

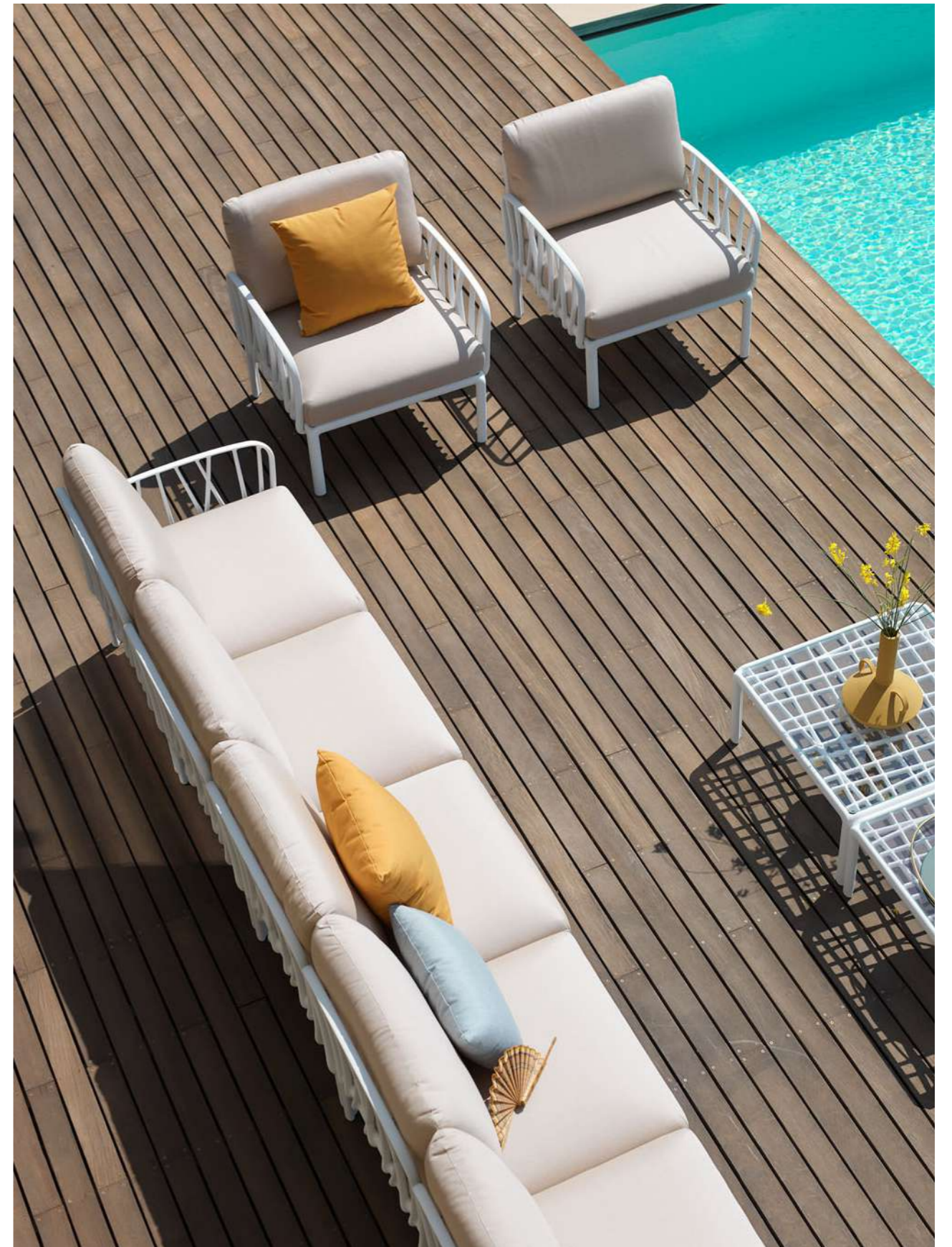



KOMODO bianco / adriatic





KOMODO TAVOLINO VETRO antracite / vetro



KOMODO antracite / rosa quarzo



KOMODO antracite / rosa quarzo
KOMODO TAVOLINO VETRO antracite / vetro

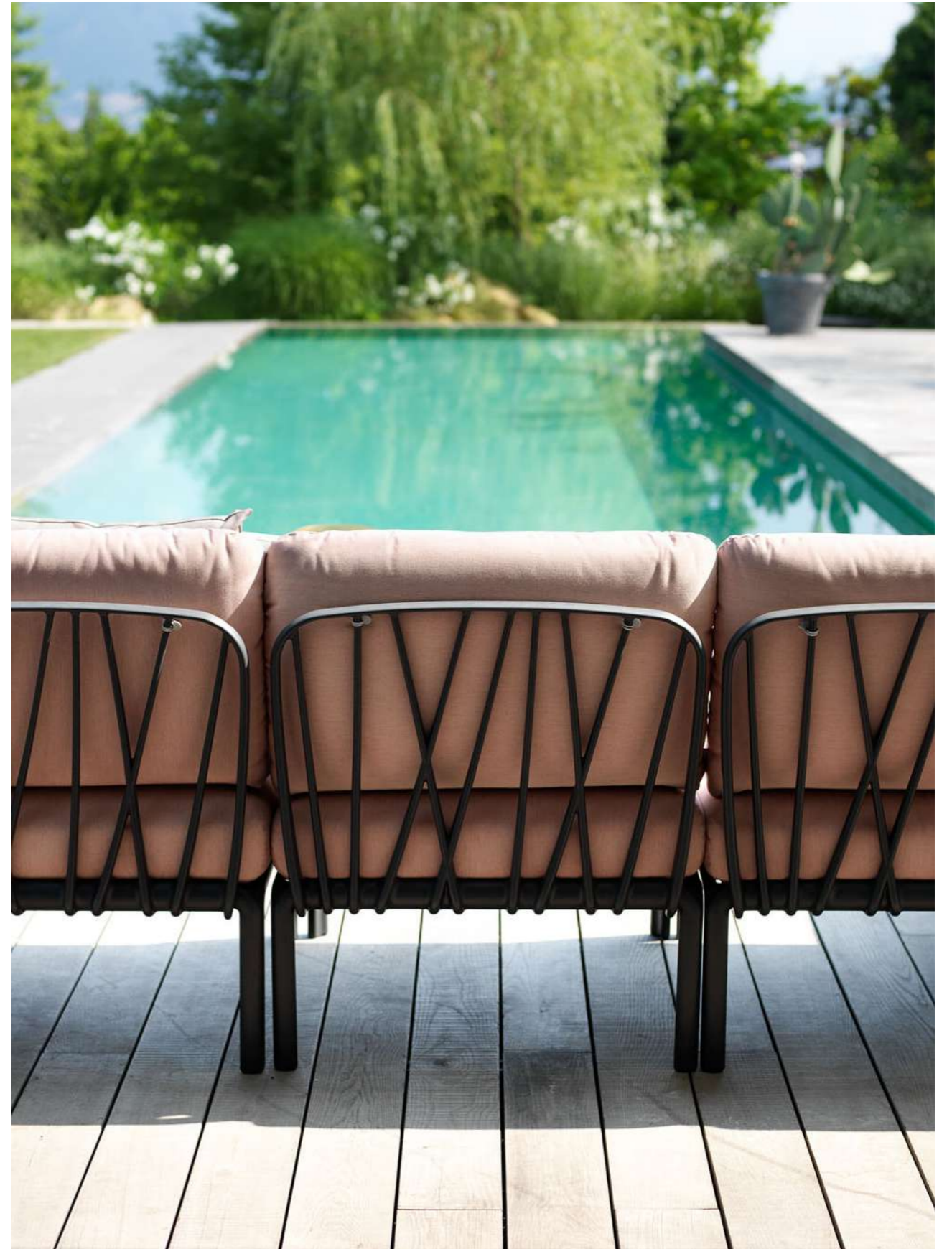



KOMODO antracite / rosa quarzo



KOMODO POUF antracite / rosa quarzo

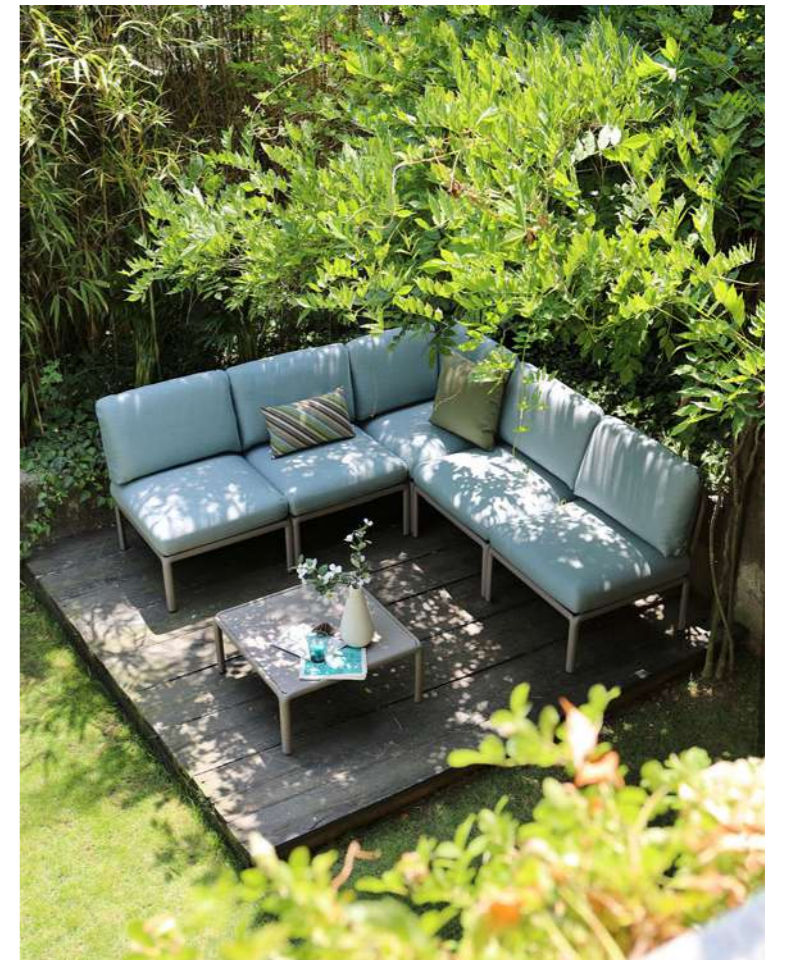

KOMODO 5 tortora / ghiaccio
KOMODO TAVOLINO tortora



KOMODO 5 tortora / ghiaccio
CUSCINO RETTANGOLARE rigato





KOMODO POLTRONA bianco / grigio
KOMODO TAVOLINO VETRO bianco / vetro





KOMODO POLTRONA bianco / grigio
KOMODO TAVOLINO VETRO bianco / vetro



KOMODO TAVOLINO VETRO bianco / vetro

Rio • Trill • Net

Chiacchierare, ridere, raccontare, trovare sempre un posto per chi arriva all'improvviso. Tavoli allungabili dalla movimentazione facile e invisibile, sedute di diverse forme, colori e gradi di comfort che permettono di creare scenografie outdoor su misura.

Chatting, laughing and telling stories, always finding a place for those who turn up unexpectedly. Tables that extend with a simple concealed movement and chairs in various shapes, colours and levels of comfort that allow you to create customised outdoor settings.





RIO ALU 210 EXTENSIBLE antracite
TRILL ARMCHAIR agave



RIO ALU 210 EXTENSIBILE antracite



TRILL BISTROT ottanio



TRILL ARMCHAIR rosa bouquet

OUTDOOR



RIO ALU 210 EXTENSIBLE antracite
NET senape



NET senape

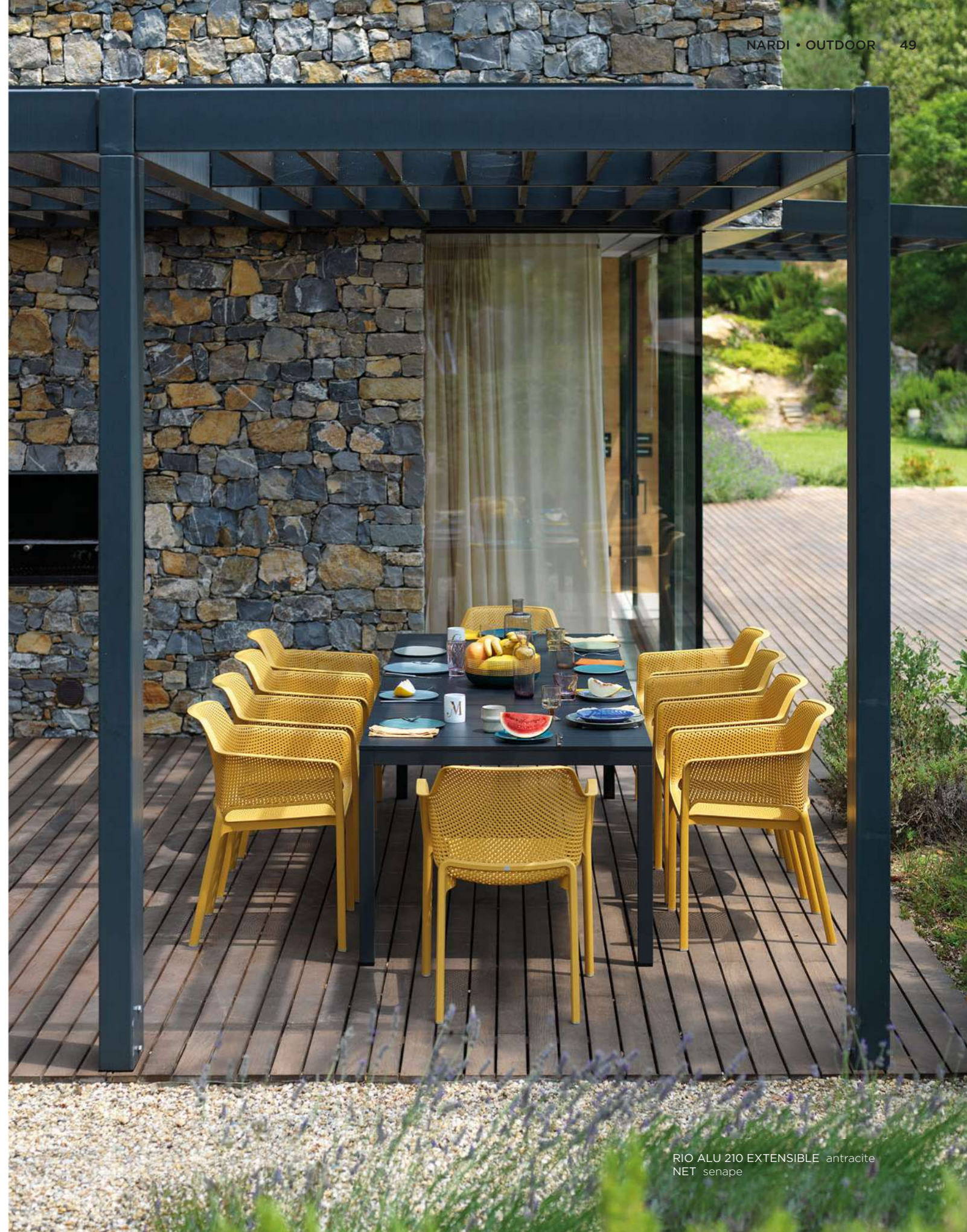

RIO ALU 210 EXTENSIBILE antracite
NET senape



RIO ALU 210 EXTENSIBLE antracite
NET senape



RIO ALU 210 EXTENSIBLE antracite



RIO 210 EXTENSIBLE tortora
NET RELAX tortora / rosa quarzo



RIO 210 EXTENSIBLE tortora
NET RELAX tortora / rosa quarzo



NET RELAX tortora
CUSCINO NET RELAX - SHELL rosa quarzo



RIO 140 EXTENSIBLE bianco
BIT bianco



BIT salice

Net collection

Raffinato relax, interpretato da armoniche palette di colori che si compongono e contrappongono in un gioco di elementi - poltroncine, divanetti, tavolini e cuscini - che dialogano tra loro per personali look open air.

Refined relaxation is expressed with harmonious colour palettes that are combined and contrasted in an interplay of elements - armchairs, sofas, side tables and cushions - that come together for a personal open-air look.

NET RELAX awards





NET BENCH - RELAX salice / sardinia
NET TABLE 100 salice



NET RELAX salice / sardinia



NET TABLE 100 salice



NET BENCH - RELAX bianco / grigio
NET TABLE 100 bianco



NET BENCH senape / denim
CUSCINO PASSEPARTOUT denim



NET BENCH - RELAX senape / denim
NET TABLE 100 senape

Aria

Progettare salotti all'aperto per godere delle serate in compagnia, della brezza del mare, dell'aria fresca di montagna. Le doghe, fil rouge stilistico della collezione, disegnano poltroncine e tavolini personalizzabili con una vasta scelta di cuscini di diverse forme e colori.

Creating outdoor lounges for enjoying evenings in company, with a sea breeze or fresh mountain air.

Slats, the recurring stylistic theme of the collection, give shape to armchairs and side tables that can be customised with a wide choice of cushions in various shapes and colours.





ARIA POLTRONA bianco / sardinia
ARIA TAVOLINO 100 bianco

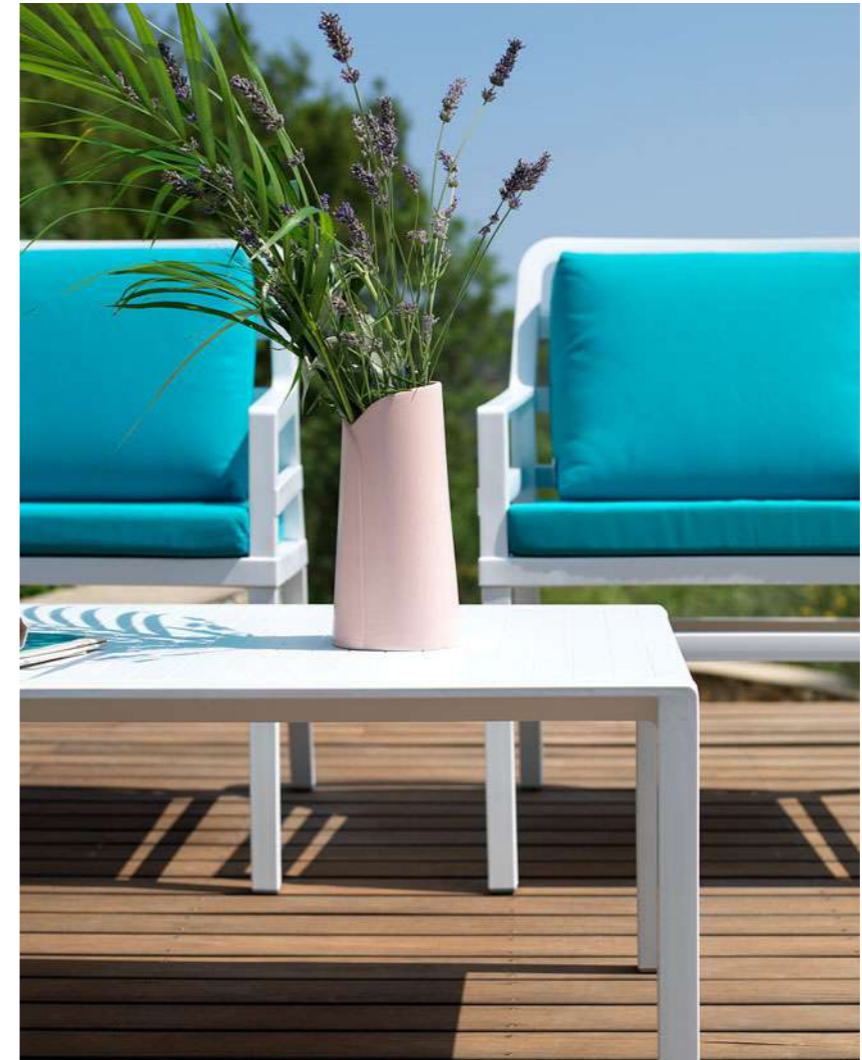



ARIA POLTRONA antracite / lime
ARIA TAVOLINO 100 antracite



ARIA TAVOLINO 100 antracite



ARIA POLTRONA antracite / lime

Alloro • Palma

Versatilità e facilità d'utilizzo sono le connotazioni dei tavoli allungabili Nardi che vantano alte prestazioni e disegnano conviviali scenari nel nome di tecnica e design. Le armoniose silhouette della struttura dei tavoli e delle sedute abbinata evocano quelle dei classici listelli di legno.

Nardi's extending tables are versatile and easy to use, offering high performance while creating convivial arrangements focused on technology and design. The harmonious silhouettes of the table frames and matching chairs are reminiscent of classic wooden slats.





ALLORO 210 EXTENSIBLE tortora / tortora
PALMA tortora / tortora



ALLORO 210 EXTENSIBLE tortora / tortora
PALMA tortora / tortora



ALLORO 210 EXTENSIBLE tortora / tortora



ALLORO 140 EXTENSIBLE bianco / tortora
PALMA bianco / tortora



ALLORO 140 EXTENSIBLE bianco / tortora



PALMA bianco / tortora

Loto • Ninfea

Atmosfere contemporanee, create attraverso l'incontro di diversi materiali - vetro, metallo, resina - che sottolineano la qualità e la ricercatezza di una collezione che assolve alle tante esigenze del vivere gli spazi all'aperto.

Contemporary atmospheres, created by combining different materials - glass, metal, resin - that underline the quality and refinement of a collection that meets the many requirements of outdoor living.





LOTO DINNER 190 antracite / antracite
NINFEA DINNER antracite / antracite





LOTORILAX 95 bianco / bianco
NINFEARELAX bianco / bianco



NINFEA RELAX bianco / bianco



LOTO RELAX 95 bianco / bianco

Atlantico • Pop

Rituali di benessere sia per gli occhi che per il corpo.
Atlantico e Pop uniscono la massima ergonomia alla qualità di dettagli e materiali.
Un concept estetico dalle linee pure ed essenziali in un'ampia scelta di colori.

*Rituals of wellbeing for the eyes and the body.
Atlantico and Pop combine excellent ergonomics with quality details and materials.
An aesthetic concept with simple elegant lines and a wide choice of colours.*





ATLANTICO tortora / agave

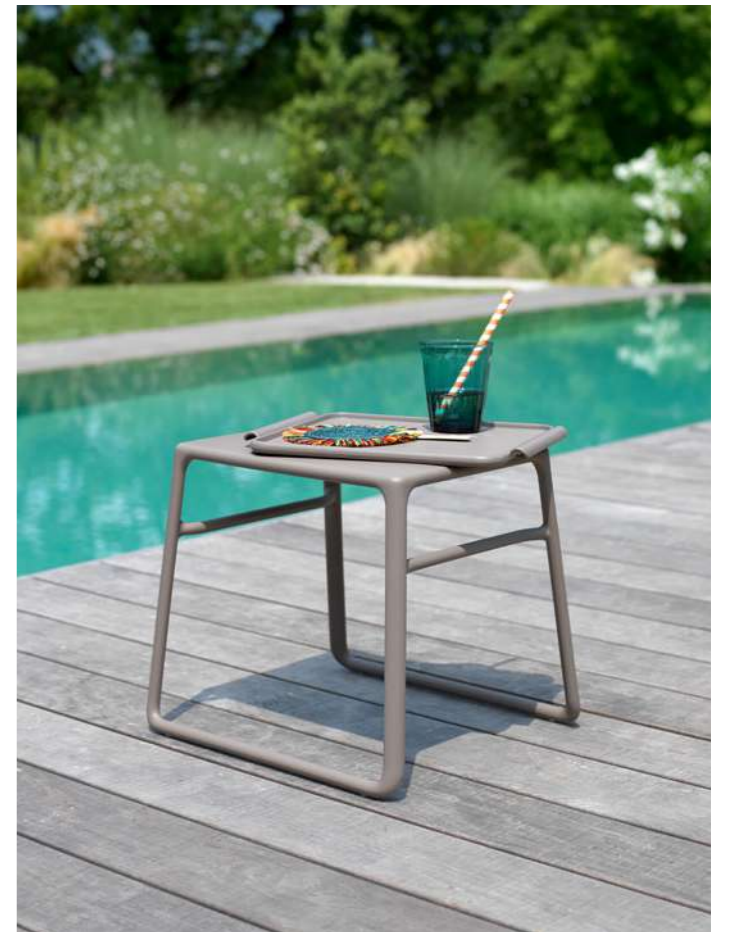

POP tortora



ATLANTICO bianco / bianco
POP bianco



ATLANTICO antracite / antracite
POP antracite

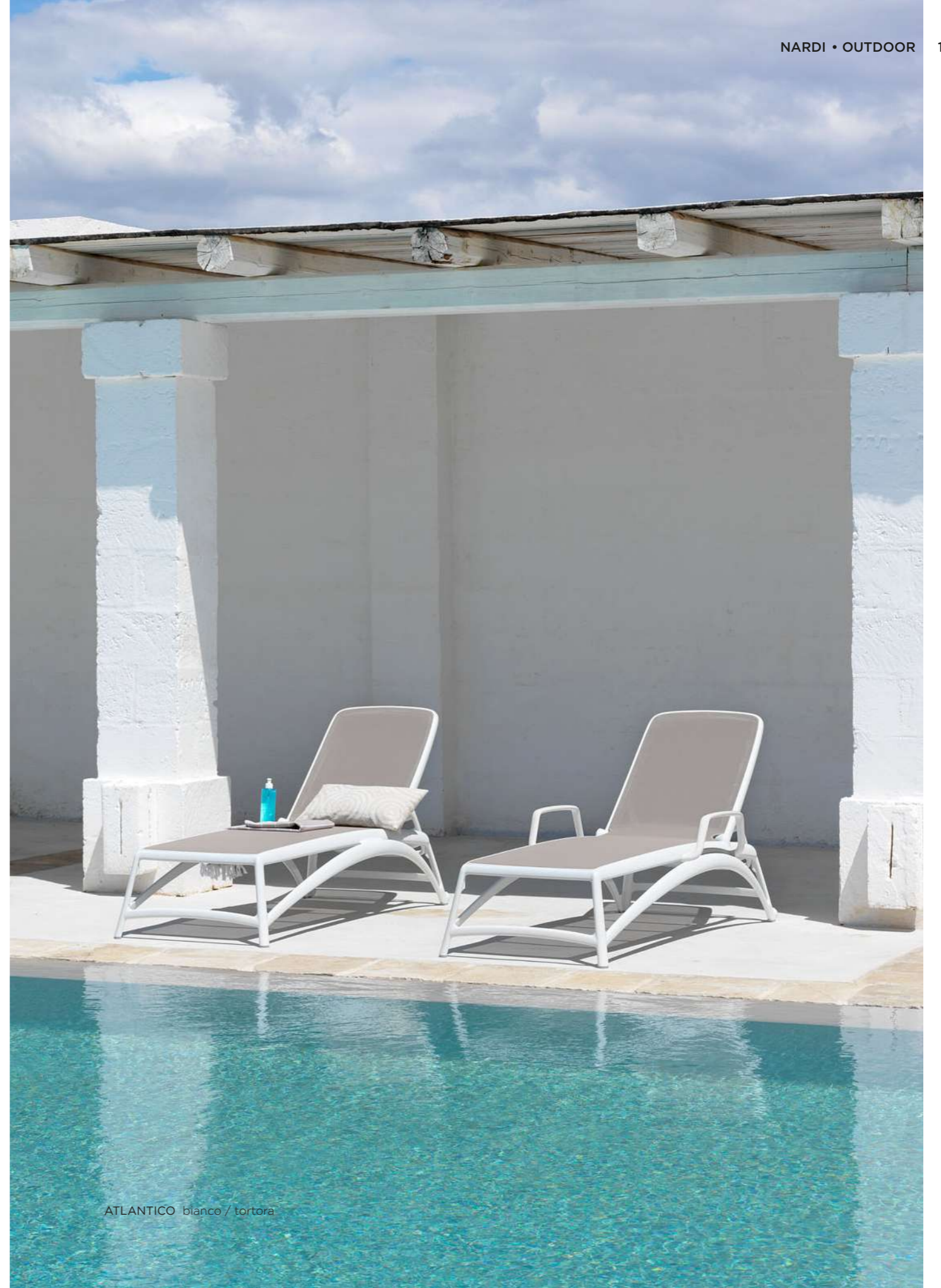

ATLANTICO bianco / tortora

Cube • Erica

Soluzioni per l'outdoor living all'insegna dei nuovi codici del vivere all'aperto che esigono versatilità e flessibilità.

Design rigoroso per una collezione di tavoli con piano squadrato, utilizzabili singolarmente o illimitatamente replicabili.

Outdoor living solutions based on new trends in open-air living that require versatility and adaptability.

A collection of tables in rigorous design with a square top. They can be used independently or endlessly aligned.





CUBE 140x80 caffè / caffè



CUBE 140x80 caffè / caffè
ERICA tortora

schede tecniche
technical details

KOMODO

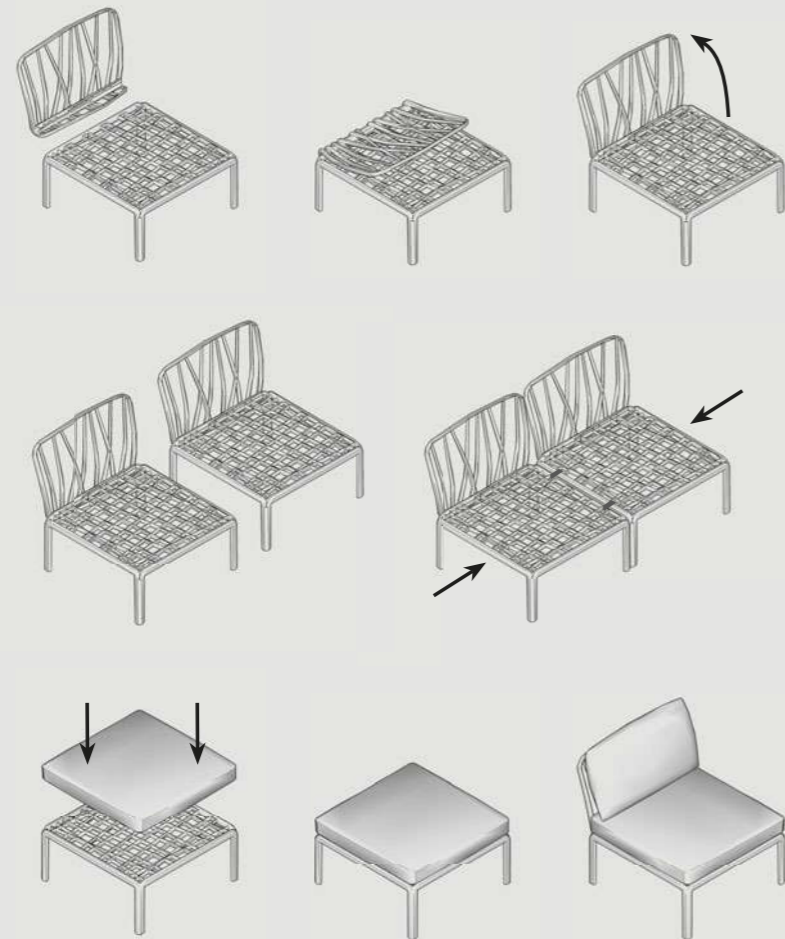

KOMODO è un sistema modulare di sedute configurabile a piacere. I moduli possono essere fissati tra loro e gli schienali e i braccioli sono agganciabili su tutti i lati della seduta.

Oltre alla versione standard KOMODO 5, è possibile configurare e ordinare la tua versione personalizzata elencando tutti i singoli elementi che la formano.

KOMODO is a modular system of upholstered seats which can be configured to suit your particular needs. The modules can be secured to one another and the backrests and armrests can be attached on all sides of the seat.

In addition to the standard KOMODO 5 version, you can configure and order your own customized version simply by listing all the individual elements you require.

KOMODO POLTRONA

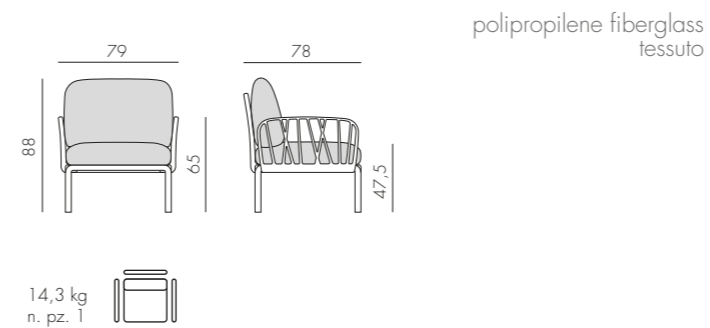

KOMODO ELEMENTO TERMINALE DX/SX

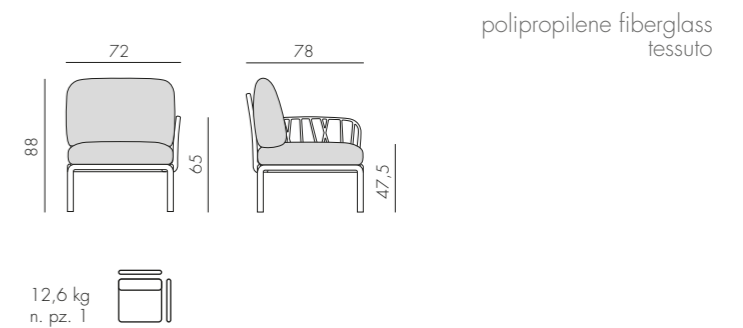

KOMODO ELEMENTO CENTRALE

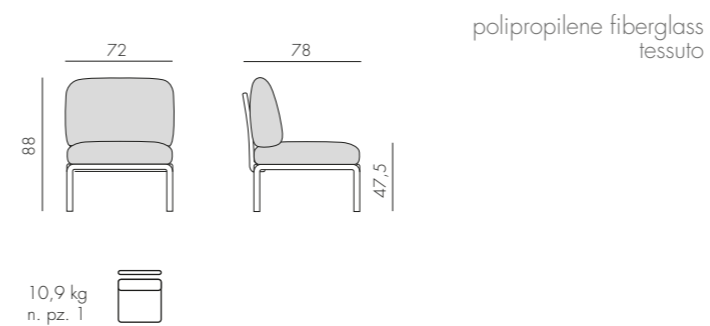

KOMODO ELEMENTO ANGOLO

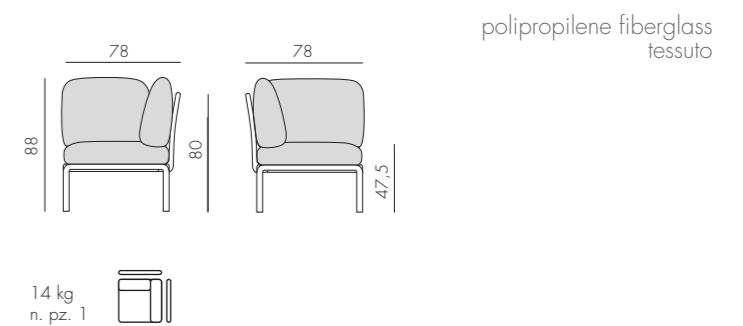

KOMODO POUF



KOMODO 5

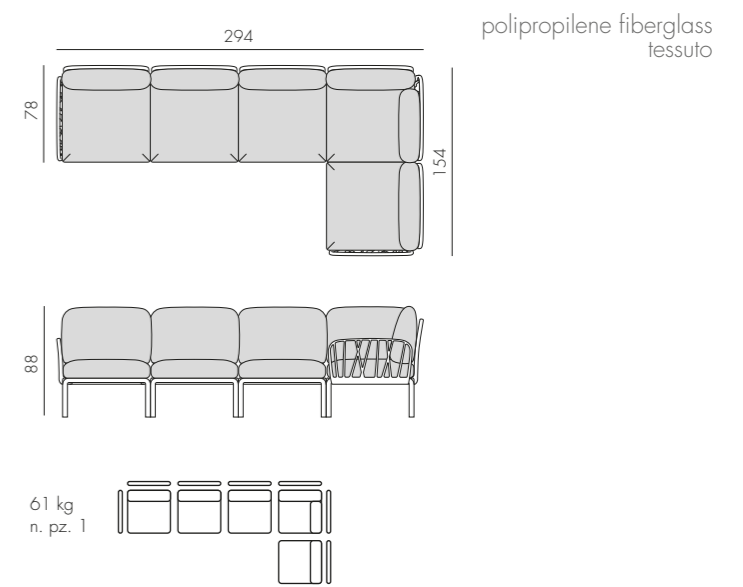



POLTRONA

ELEMENTO
TERMINALE
DX/SXELEMENTO
CENTRALEELEMENTO
ANGOLO

POUF

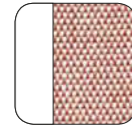

KOMODO 5

BIANCO
rosa quarzo

40371.00.066

40372.00.066

40373.00.066

40374.00.066

40369.00.066

40370.00.066

ANTRACITE
rosa quarzo

40371.02.066

40372.02.066

40373.02.066

40374.02.066

40369.02.066

40370.02.066

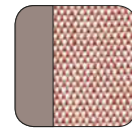
TORTORA
rosa quarzo

40371.10.066

40372.10.066

40373.10.066

40374.10.066

40369.10.066

40370.10.066

newAGAVE
rosa quarzo

40371.16.066

40372.16.066

40373.16.066

40374.16.066

40369.16.066

40370.16.066

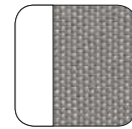
BIANCO
grigio

40371.00.163

40372.00.163

40373.00.163

40374.00.163

40369.00.163

40370.00.163

ANTRACITE
grigio

40371.02.163

40372.02.163

40373.02.163

40374.02.163

40369.02.163

40370.02.163

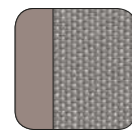
TORTORA
grigio

40371.10.163

40372.10.163

40373.10.163

40374.10.163

40369.10.163

40370.10.163

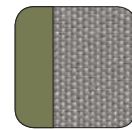
newAGAVE
grigio

40371.16.163

40372.16.163

40373.16.163

40374.16.163

40369.16.163

40370.16.163



POLTRONA

ELEMENTO
TERMINALE
DX/SXELEMENTO
CENTRALEELEMENTO
ANGOLO

POUF

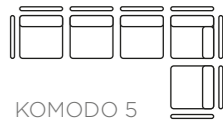

KOMODO 5

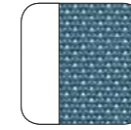
BIANCO
adriatic
Sunbrella®

40371.00.142

40372.00.142

40373.00.142

40374.00.142

40369.00.142

40370.00.142

ANTRACITE
adriatic
Sunbrella®

40371.02.142

40372.02.142

40373.02.142

40374.02.142

40369.02.142

40370.02.142

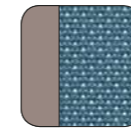
TORTORA
adriatic
Sunbrella®

40371.10.142

40372.10.142

40373.10.142

40374.10.142

40369.10.142

40370.10.142

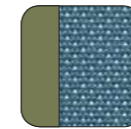
newAGAVE
adriatic
Sunbrella®

40371.16.142

40372.16.142

40373.16.142

40374.16.142

40369.16.142

40370.16.142

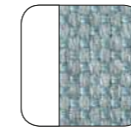
newBIANCO
ghiaccio
Sunbrella®

40371.00.138

40372.00.138

40373.00.138

40374.00.138

40369.00.138

40370.00.138

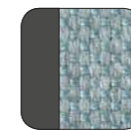
newANTRACITE
ghiaccio
Sunbrella®

40371.02.138

40372.02.138

40373.02.138

40374.02.138

40369.02.138

40370.02.138

newTORTORA
ghiaccio
Sunbrella®

40371.10.138

40372.10.138

40373.10.138

40374.10.138

40369.10.138

40370.10.138

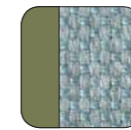
newAGAVE
ghiaccio
Sunbrella®

40371.16.138

40372.16.138

40373.16.138

40374.16.138

40369.16.138

40370.16.138



POLTRONA

ELEMENTO
TERMINALE
DX/SXELEMENTO
CENTRALEELEMENTO
ANGOLO

POUF



KOMODO 5

new BIANCO avocado Sunbrella®		40371.00.139	40372.00.139	40373.00.139	40374.00.139	40369.00.139	40370.00.139
---	--	--------------	--------------	--------------	--------------	--------------	--------------

new ANTRACITE avocado Sunbrella®		40371.02.139	40372.02.139	40373.02.139	40374.02.139	40369.02.139	40370.02.139
--	--	--------------	--------------	--------------	--------------	--------------	--------------

new TORTORA avocado Sunbrella®		40371.10.139	40372.10.139	40373.10.139	40374.10.139	40369.10.139	40370.10.139
--	--	--------------	--------------	--------------	--------------	--------------	--------------

new AGAVE avocado Sunbrella®		40371.16.139	40372.16.139	40373.16.139	40374.16.139	40369.16.139	40370.16.139
--	--	--------------	--------------	--------------	--------------	--------------	--------------

new BIANCO giungla Sunbrella®		40371.00.140	40372.00.140	40373.00.140	40374.00.140	40369.00.140	40370.00.140
---	--	--------------	--------------	--------------	--------------	--------------	--------------

new ANTRACITE giungla Sunbrella®		40371.02.140	40372.02.140	40373.02.140	40374.02.140	40369.02.140	40370.02.140
--	--	--------------	--------------	--------------	--------------	--------------	--------------

new TORTORA giungla Sunbrella®		40371.10.140	40372.10.140	40373.10.140	40374.10.140	40369.10.140	40370.10.140
--	--	--------------	--------------	--------------	--------------	--------------	--------------

new AGAVE giungla Sunbrella®		40371.16.140	40372.16.140	40373.16.140	40374.16.140	40369.16.140	40370.16.140
--	--	--------------	--------------	--------------	--------------	--------------	--------------



POLTRONA

ELEMENTO
TERMINALE
DX/SXELEMENTO
CENTRALEELEMENTO
ANGOLO

POUF

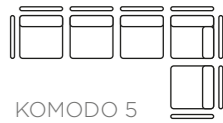

KOMODO 5

new BIANCO canvas Sunbrella® laminato		40371.00.170	40372.00.170	40373.00.170	40374.00.170	40369.00.170	40370.00.170
--	--	--------------	--------------	--------------	--------------	--------------	--------------

new ANTRACITE canvas Sunbrella® laminato		40371.02.170	40372.02.170	40373.02.170	40374.02.170	40369.02.170	40370.02.170
---	--	--------------	--------------	--------------	--------------	--------------	--------------

new TORTORA canvas Sunbrella® laminato		40371.10.170	40372.10.170	40373.10.170	40374.10.170	40369.10.170	40370.10.170
---	--	--------------	--------------	--------------	--------------	--------------	--------------

new AGAVE canvas Sunbrella® laminato		40371.16.170	40372.16.170	40373.16.170	40374.16.170	40369.16.170	40370.16.170
---	--	--------------	--------------	--------------	--------------	--------------	--------------

new BIANCO TECH panama		40371.00.131	40372.00.131	40373.00.131	40374.00.131	40369.00.131	40370.00.131
-------------------------------------	--	--------------	--------------	--------------	--------------	--------------	--------------

new ANTRACITE TECH panama		40371.02.131	40372.02.131	40373.02.131	40374.02.131	40369.02.131	40370.02.131
--	--	--------------	--------------	--------------	--------------	--------------	--------------

new TORTORA TECH panama		40371.10.131	40372.10.131	40373.10.131	40374.10.131	40369.10.131	40370.10.131
--------------------------------------	--	--------------	--------------	--------------	--------------	--------------	--------------

new AGAVE TECH panama		40371.16.131	40372.16.131	40373.16.131	40374.16.131	40369.16.131	40370.16.131
------------------------------------	--	--------------	--------------	--------------	--------------	--------------	--------------

KOMODO TAVOLINO

polipropilene fiberglass

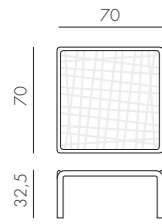
6,7 kg
n. pz. 1

BIANCO 40378.00.000
ANTRACITE 40378.02.000
TORTORA 40378.10.000
AGAVE 40378.16.000

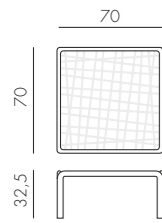
KOMODO TAVOLINO VETRO **new**polipropilene fiberglass
vetro11,4 kg
n. pz. 1

BIANCO vetro 40368.00.501
ANTRACITE vetro 40368.02.501
TORTORA vetro 40368.10.501
AGAVE vetro 40368.16.501

KOMODO BRACCIOLO

polipropilene fiberglass

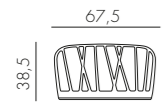
1,7 kg
n. pz. 2

BIANCO 40375.00.000
ANTRACITE 40375.02.000
TORTORA 40375.10.000
AGAVE 40375.16.000

KOMODO SCHIENALE

polipropilene fiberglass

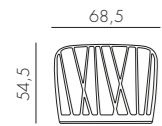
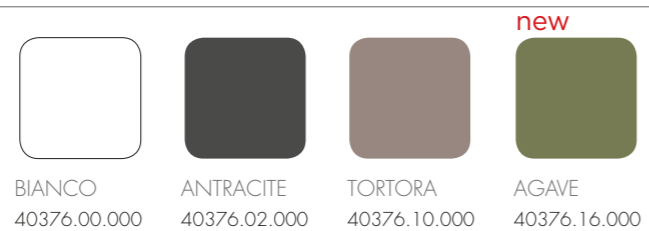
2 kg
n. pz. 4

BIANCO 40376.00.000
ANTRACITE 40376.02.000
TORTORA 40376.10.000
AGAVE 40376.16.000

KOMODO ECOWALL **new**

polipropilene fiberglass rigenerato

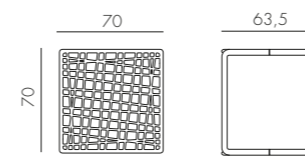
10 kg
n. pz. 1TERRA
40380.44.000

CUSCINO SCHIENALE KOMODO

tessuto

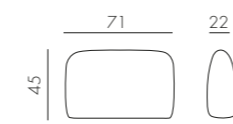
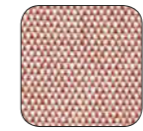
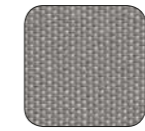
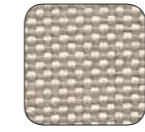
1,4 kg
n. pz. 1rosa quarzo
36370.52.066grigio
36370.52.163adriatic Sunbrella®
36370.52.142ghiaccio Sunbrella®
36370.52.138avocado Sunbrella®
36370.52.139giungla Sunbrella®
36370.52.140canvas Sunbrella®
laminato
36370.52.170TECH panama
36370.52.131

CUSCINO SCHIENALE ANGOLO KOMODO

tessuto

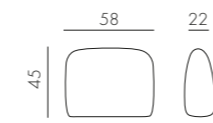
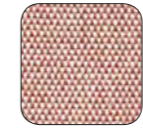
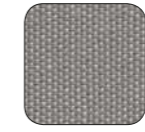
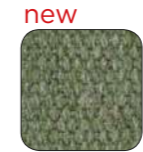
1,1 kg
n. pz. 1rosa quarzo
36370.54.066grigio
36370.54.163adriatic Sunbrella®
36370.54.142ghiaccio Sunbrella®
36370.54.138avocado Sunbrella®
36370.54.139giungla Sunbrella®
36370.54.140canvas Sunbrella®
laminato
36370.54.170TECH panama
36370.54.131

TRILL ARMCHAIR

polipropilene fiberglass

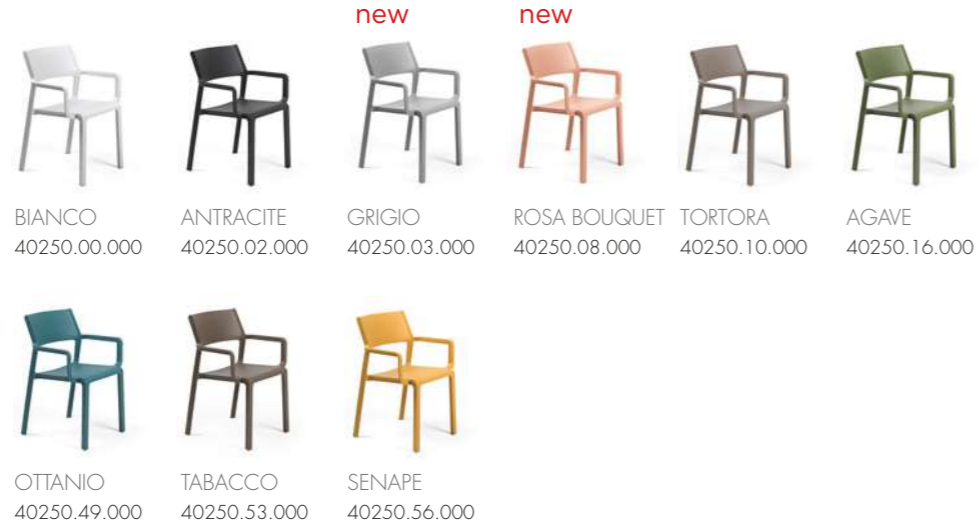
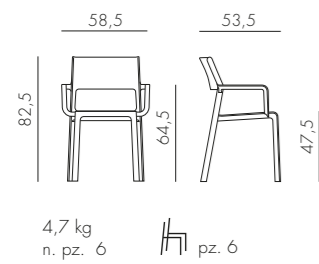

TRILL STOOL

polipropilene fiberglass

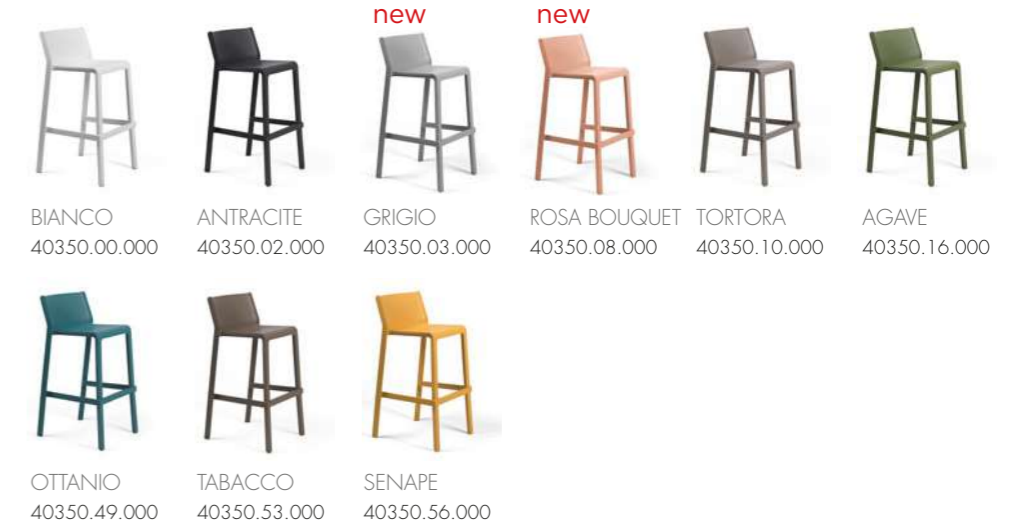
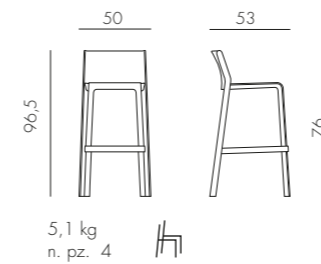

TRILL BISTROT

polipropilene fiberglass

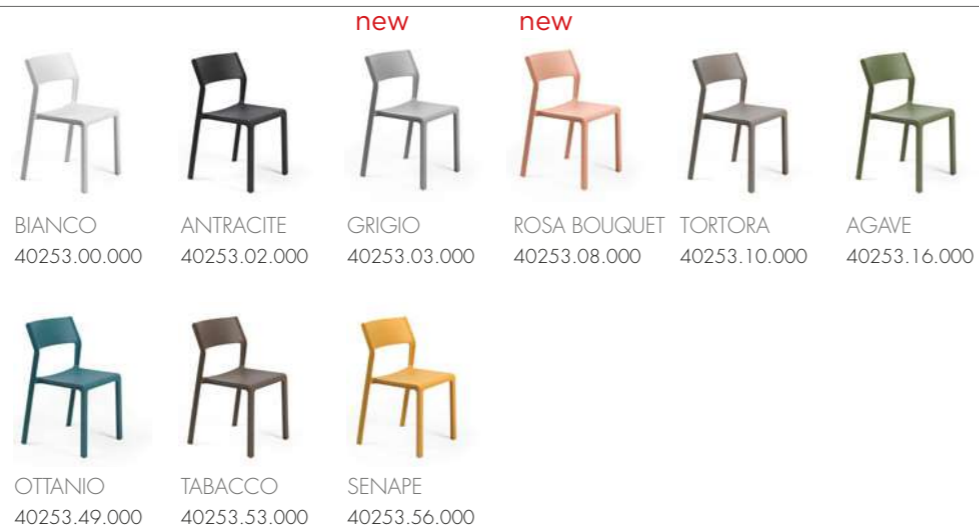
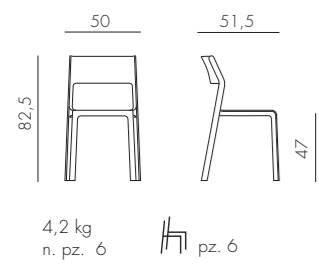

TRILL STOOL MINI

polipropilene fiberglass

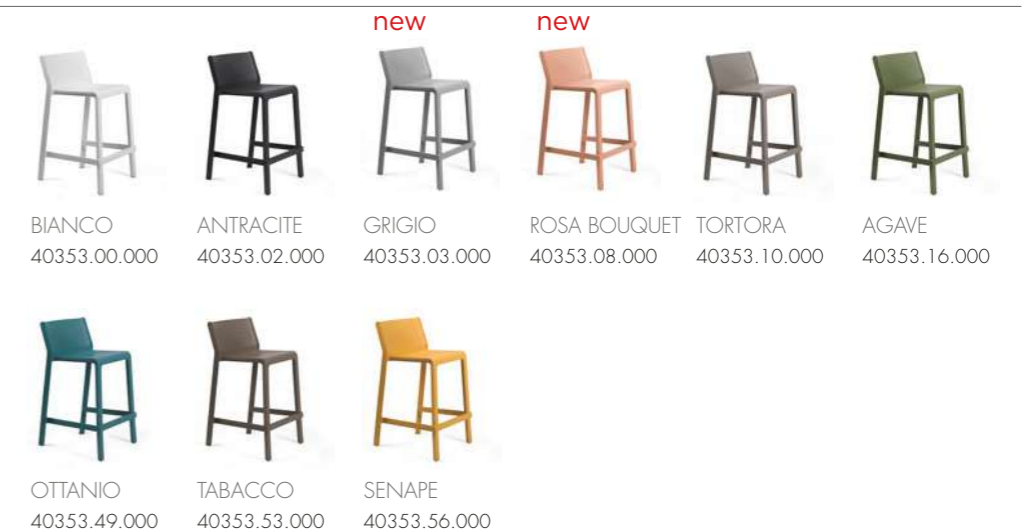
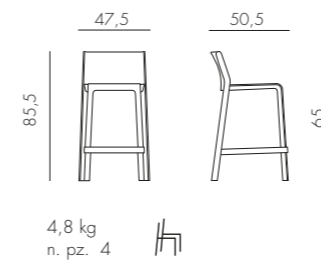

NET BENCH

polipropilene fiberglass

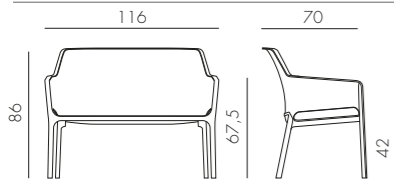

8,9 kg
n. pz. 20



BIANCO 40338.00.000 ANTRACITE 40338.02.000 SALICE 40338.04.000 TORTORA 40338.10.000 SENAPE 40338.56.000 CORALLO 40338.75.000

NET RELAX

polipropilene fiberglass

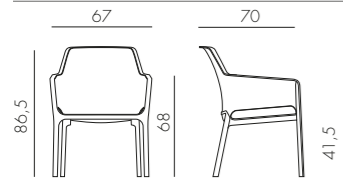

4,9 kg
n. pz. 20



pz. 6



BIANCO 40327.00.000 ANTRACITE 40327.02.000 SALICE 40327.04.000 TORTORA 40327.10.000 SENAPE 40327.56.000 CORALLO 40327.75.000

NET

polipropilene fiberglass

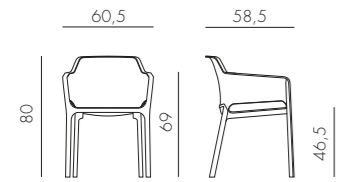

3,9 kg
n. pz. 6



pz. 6



BIANCO 40326.00.000.06 ANTRACITE 40326.02.000.06 SALICE 40326.04.000.06 TORTORA 40326.10.000.06 SENAPE 40326.56.000.06 CORALLO 40326.75.000.06

BIT

polipropilene fiberglass

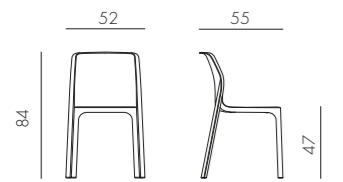

3,5 kg
n. pz. 6



pz. 6



BIANCO 40328.00.000.06 ANTRACITE 40328.02.000.06 SALICE 40328.04.000.06 TORTORA 40328.10.000.06 SENAPE 40328.56.000.06 CORALLO 40328.75.000.06

NET STOOL **new**

polipropilene fiberglass

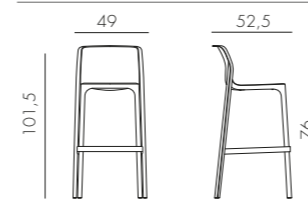

4,4 kg
n. pz. 4



BIANCO 40355.00.000 ANTRACITE 40355.02.000 SALICE 40355.04.000 TORTORA 40355.10.000 SENAPE 40355.56.000 CORALLO 40355.75.000

NET STOOL MINI **new**

polipropilene fiberglass

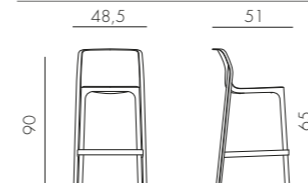

4,2 kg
n. pz. 4



BIANCO 40356.00.000 ANTRACITE 40356.02.000 SALICE 40356.04.000 TORTORA 40356.10.000 SENAPE 40356.56.000 CORALLO 40356.75.000

PALMA

polipropilene

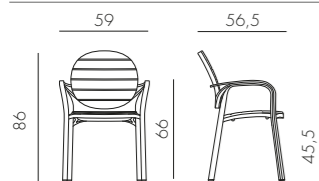
5,2 kg
n. pz. 6

BIANCO 40237.00.000
 BIANCO TORTORA 40237.00.010
 ANTRACITE 40237.02.002
 CAFFÈ 40237.05.005
 TORTORA 40237.10.010

ERICA

polipropilene

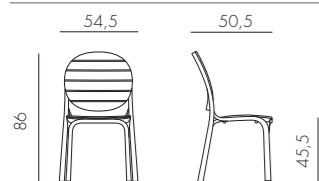
4,2 kg
n. pz. 22

BIANCO 40236.00.000
 BIANCO TORTORA 40236.00.010
 ANTRACITE 40236.02.002
 CAFFÈ 40236.05.005
 TORTORA 40236.10.010

NINFEA DINNER

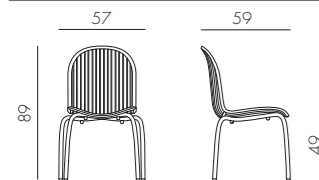
polipropilene
alluminio4,5 kg
n. pz. 6

ANTRACITE vernic. antracite 62052.02.000
 BIANCO vernic. bianco 62053.00.000

NINFEA RELAX

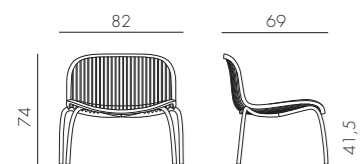
polipropilene
alluminio7,2 kg
n. pz. 2

ANTRACITE vernic. antracite 62252.02.000
 BIANCO vernic. bianco 62253.00.000

polipropilene
tessuto

ARIA (POLTRONA ARIA + CUSCINO SEDUTA + CUSCINO ARREDO)

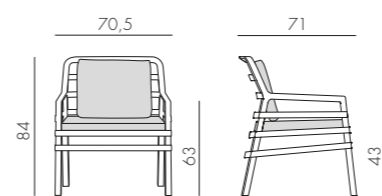
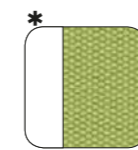
7,9 kg
n. pz. 1

BIANCO lime
40330.00.061.061



ANTRACITE lime
40330.02.061.061

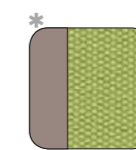

TORTORA lime
40330.10.061.061

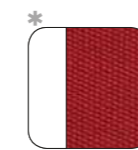

BIANCO cherry
40330.00.065.065



ANTRACITE cherry
40330.02.065.065

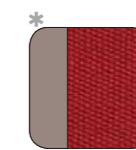

TORTORA cherry
40330.10.065.065

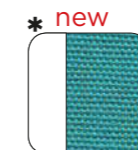

BIANCO sardinia
40330.00.072.072



ANTRACITE sardinia
40330.02.072.072

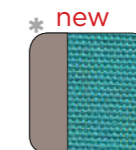

TORTORA sardinia
40330.10.072.072

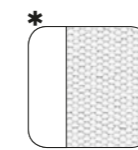

BIANCO bianco
40330.00.155.155



ANTRACITE bianco
40330.02.155.155

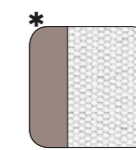

TORTORA bianco
40330.10.155.155

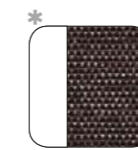

BIANCO caffè
40330.00.165.165



ANTRACITE caffè
40330.02.165.165

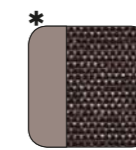

TORTORA caffè
40330.10.165.165

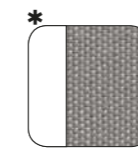

BIANCO grigio
40330.00.163.163

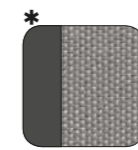

ANTRACITE grigio
40330.02.163.163

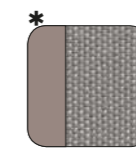

TORTORA grigio
40330.10.163.163

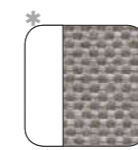

BIANCO grigio Sunbrella®
40330.00.136.136



ANTRACITE grigio Sunbrella®
40330.02.136.136

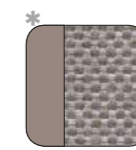

TORTORA grigio Sunbrella®
40330.10.136.136

* Disponibile a magazzino
 Available ex-stock
 Disponible sur stock
 Ab Lager verfügbar
 Disponible en almacén habitualmente
 Disponivel em estoque
 Stokta mevcut
 Наличие на складе

* Disponibile su ordine
 Available to order
 Disponible sur commande
 Mit Auftrag verfügbar
 Disponible sólo sobre pedido
 Disponivel sob encomenda
 Sipariş göre hazırlanacaktır
 Под заказ

ARIA FIT (POLTRONA ARIA + CUSCINO SEDUTA + CUSCINO FIT)

polipropilene tessuto

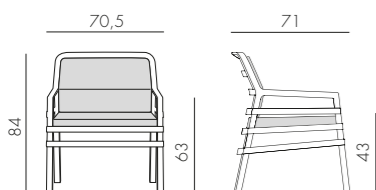

7,9 kg
n. pz. 1

BIANCO bianco 40330.00.155.FIT	ANTRACITE bianco 40330.02.155.FIT	TORTORA bianco 40330.10.155.FIT
BIANCO caffè 40330.00.165.FIT	ANTRACITE caffè 40330.02.165.FIT	TORTORA caffè 40330.10.165.FIT
BIANCO grigio 40330.00.163.FIT	ANTRACITE grigio 40330.02.163.FIT	TORTORA grigio 40330.10.163.FIT
BIANCO grigio Sunbrella® 40330.00.136.FIT	ANTRACITE grigio Sunbrella® 40330.02.136.FIT	TORTORA grigio Sunbrella® 40330.10.136.FIT

* Disponibile su ordine
Available to order
Disponibile sur commande
Mit Auftrag verfügbar
Disponibile sólo sobre pedido
Disponível sob encomenda
Sipariş göre hazırlanacaktır
Под заказ

ATLANTICO

polipropilene fiberglass tessuto sintetico

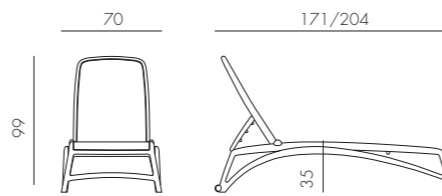

16 kg
n. pz. 20

Tessuto ricambiabile
Replaceable fabric
Tissu changeable
Auswechselbarer Stoff
Tela sustituible
Tecidos recambiables
Değiştirilebilen Kumaş
Съемная ткань

BIANCO celeste 40450.00.075	BIANCO tortora 40450.00.104	BIANCO bianco 40450.00.107	ANTRACITE antracite 40450.02.057	ANTRACITE celeste 40450.02.075
CAFFÈ celeste 40450.05.075	CAFFÈ tortora 40450.05.104	TORTORA celeste 40450.10.075	TORTORA tortora 40450.10.104	TORTORA bianco 40450.10.107
TORTORA agave 40450.10.101	TORTORA deserto 40450.10.103			

RICAMBIO atlantico

resina acetlica tessuto sintetico

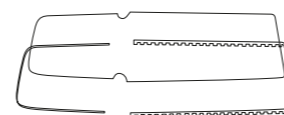

1,3 kg
n. pz. 1

celeste 40460.00.075	tortora 40460.00.104	bianco 40460.00.107	antracite 40460.01.057	celeste 40460.01.075
tortora 40460.01.104	agave 40460.10.101	deserto 40460.10.103		

BRACCIOLO ATLANTICO

polipropilene fiberglass

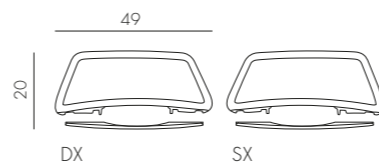

1,1 kg
n. pz. 1

BIANCO 40452.00.000	ANTRACITE 40452.02.000	CAFFÈ 40452.05.000	TORTORA 40452.10.000

RIO - RIO ALU

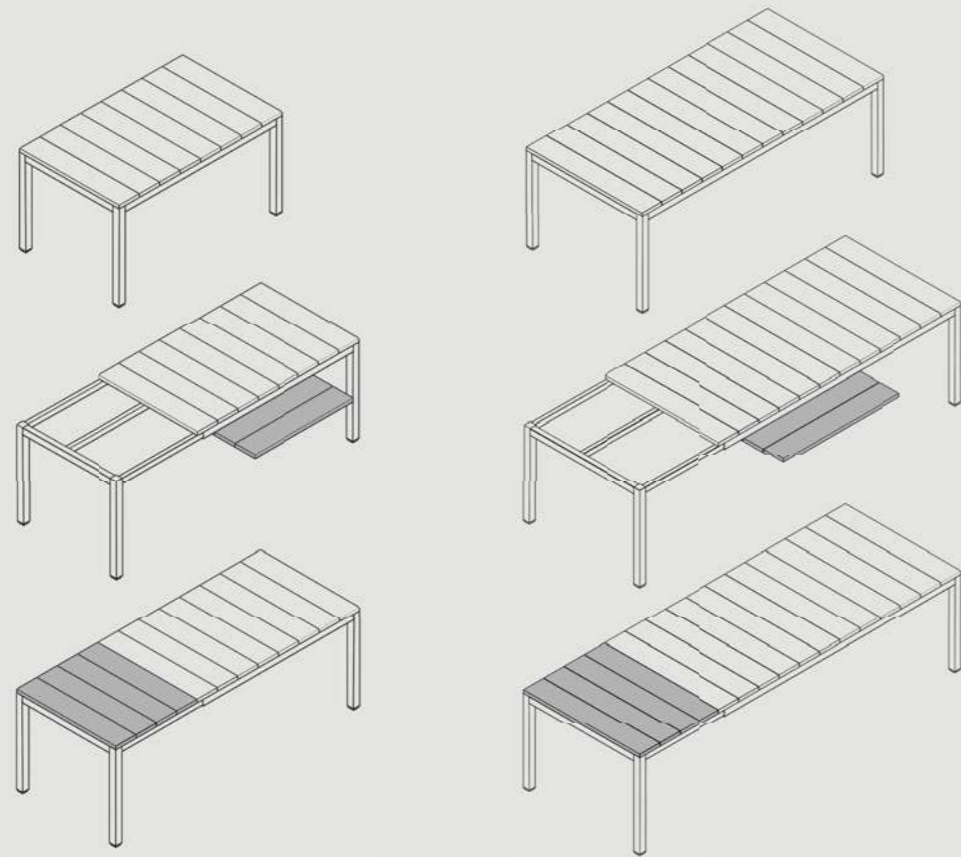

rio 140 extensible
6/8 🧑 140/210x85x76 cm

rio Alu 140 extensible
6/8 🧑 140/210x85x75 cm

rio 210 extensible
8/10 🧑 210/280x100x76 cm

rio Alu 210 extensible
8/10 🧑 210/280x100x75 cm

ALLORO

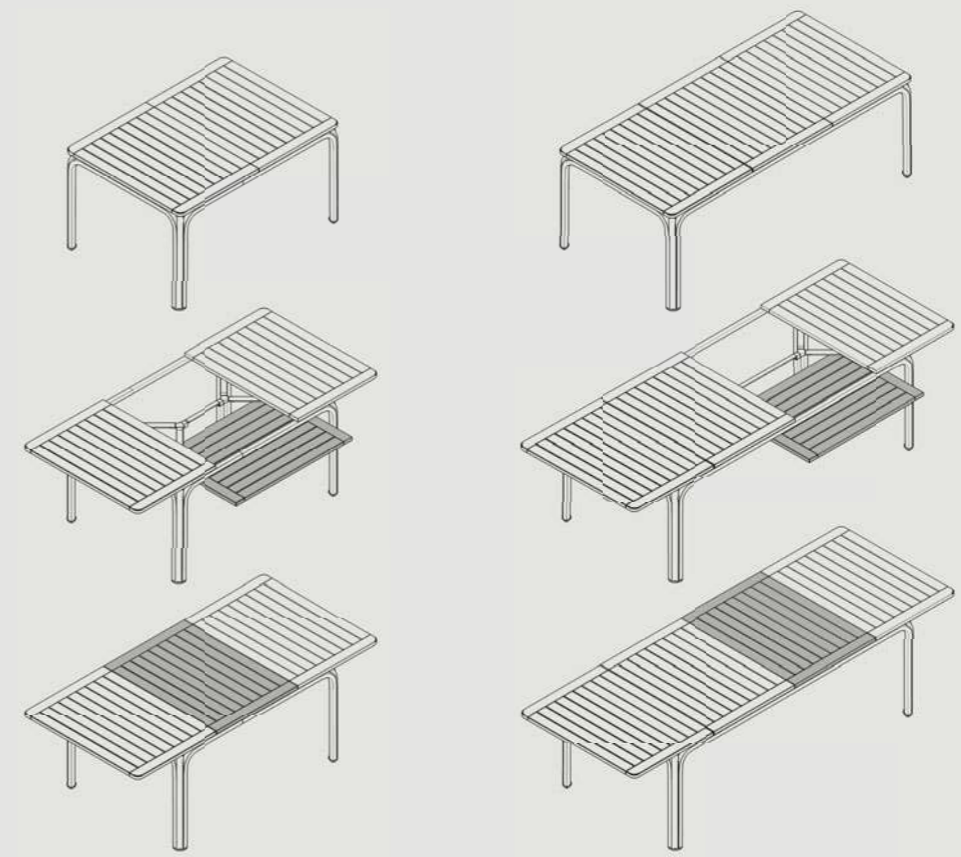

alloro 140 extensible
6/8 🧑 140/210x100x73 cm

alloro 210 extensible
8/10 🧑 210/280x100x73 cm

RIO ALU 210 EXTENSIBLE **new**

8/10

alluminio

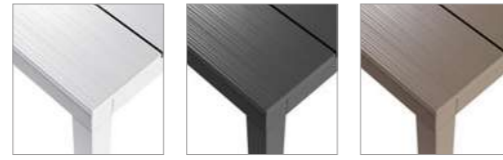
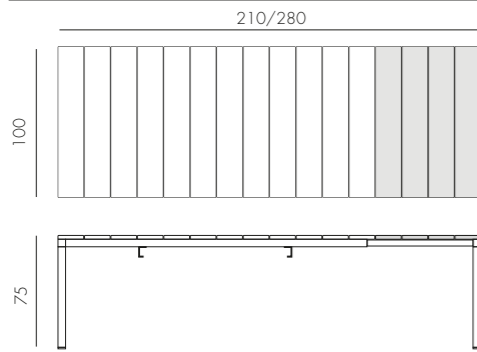
verniciato bianco
48853.00.000verniciato antracite
48852.02.000verniciato tortora
48859.10.00054 kg
n. pz. 1RIO ALU 140 EXTENSIBLE **new**

6/8

alluminio

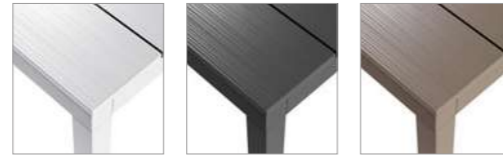
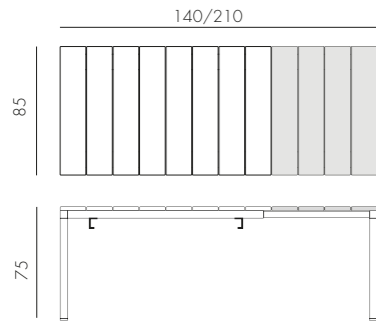
verniciato bianco
48653.00.000verniciato antracite
48652.02.000verniciato tortora
48659.10.00037,1 kg
n. pz. 1

RIO 210 EXTENSIBLE

8/10

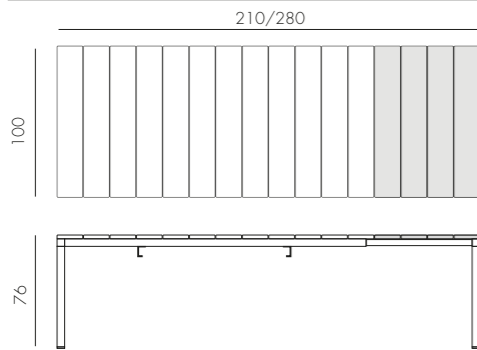
durelTOP - polipropilene
alluminioBIANCO
verniciato bianco
48253.00.000ANTRACITE *
verniciato antracite
48252.02.000TORTORA
verniciato tortora
48259.10.00049 kg
n. pz. 1

* Posizionare in zona d'ombra - Only use table tops in shaded areas - Plateaux qui doivent être utilisés uniquement dans des zones ombragées -
Tischplatten nur für beschatteten Einsatzbereich - Utilizar estos tableros sólo en áreas sombreadas - Colocar em local sombreado - Gölge alana koyun -
Ставить в тени

RIO 140 EXTENSIBLE

6/8

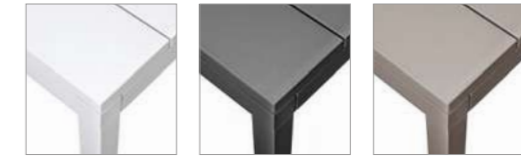
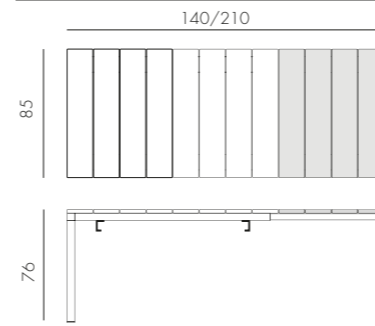
durelTOP - polipropilene
alluminioBIANCO
verniciato bianco
48353.00.000ANTRACITE *
verniciato antracite
48352.02.000TORTORA
verniciato tortora
48359.10.00032,6 kg
n. pz. 1

ALLORO 210 EXTENSIBLE

8/10

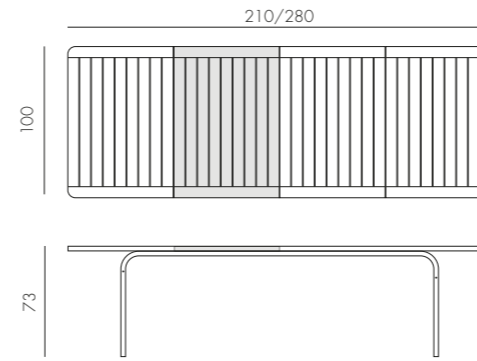
durelTOP - polipropilene
alluminioBIANCO
verniciato bianco
42853.00.000TORTORA
verniciato bianco
42853.10.000ANTRACITE *
verniciato antracite
42852.02.000CAFFÈ *
verniciato caffè
42857.05.000TORTORA
verniciato tortora
42859.10.00044,4 kg
n. pz. 1

ALLORO 140 EXTENSIBLE

6/8

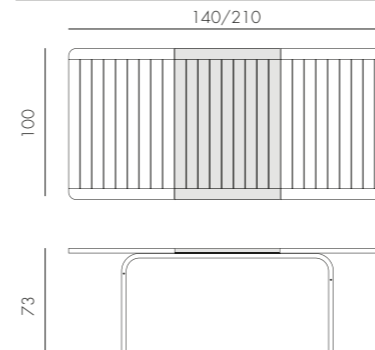
durelTOP - polipropilene
alluminioBIANCO
verniciato bianco
42753.00.000TORTORA
verniciato bianco
42753.10.000ANTRACITE *
verniciato antracite
42752.02.000CAFFÈ *
verniciato caffè
42757.05.000TORTORA
verniciato tortora
42759.10.00033,7 kg
n. pz. 1

* Posizionare in zona d'ombra - Only use table tops in shaded areas - Plateaux qui doivent être utilisés uniquement dans des zones ombragées -
Tischplatten nur für beschatteten Einsatzbereich - Utilizar estos tableros sólo en áreas sombreadas - Colocar em local sombreado - Gölge alana koyun -
Ставить в тени

LOTO DINNER 190

vetro
alluminio

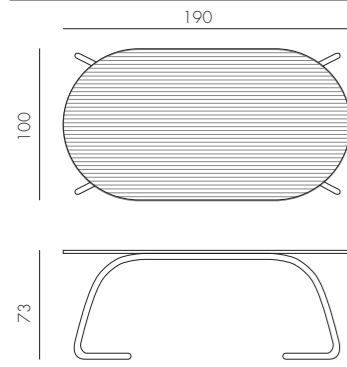

ANTRACITE
verniciato antracite
44052.02.000



BIANCO
verniciato bianco
44053.00.000

49,8 kg
n. pz. 1

LOTO DINNER Ø170

vetro
alluminio

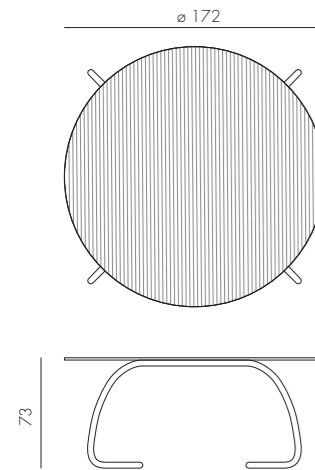

ANTRACITE
verniciato antracite
44452.02.000



BIANCO
verniciato bianco
44453.00.000

65,3 kg
n. pz. 1

LOTO DINNER Ø120

vetro
alluminio

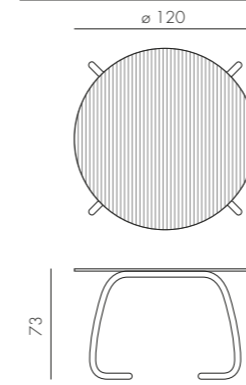

ANTRACITE
verniciato antracite
44352.02.000



BIANCO
verniciato bianco
44353.00.000

34 kg
n. pz. 1

LOTO RELAX 95

vetro
alluminio

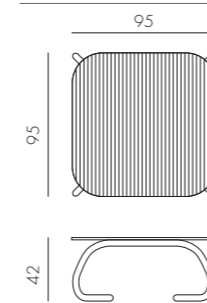

ANTRACITE
verniciato antracite
44752.02.000



BIANCO
verniciato bianco
44753.00.000

27 kg
n. pz. 1

LOTO RELAX 60

laminato
alluminio



ANTRACITE *
verniciato antracite
44652.00.303



BIANCO
verniciato bianco
44653.00.301

7 kg
n. pz. 1

* Posizionare in zona d'ombra - Only use table tops in shaded areas - Plateaux qui doivent être utilisés uniquement dans des zones ombragées - Tischplatten nur für beschatteten Einsatzbereich - Utilizar estos tableros sólo en áreas sombreadas - Colocar em local sombreado - Gólge alana koyun - Ставить в тени

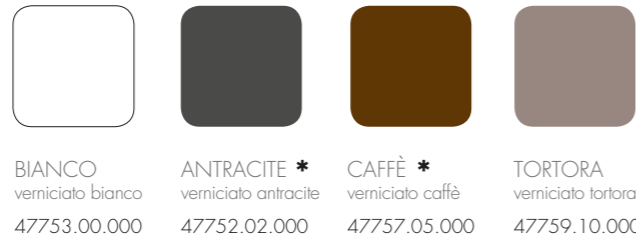
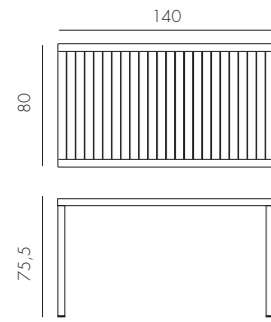
CUBE 140X80 **new**durelTOP - polipropilene
alluminio

BIANCO
verniciato bianco
47753.00.000

ANTRACITE *
verniciato antracite
47752.02.000

CAFFÈ *
verniciato caffè
47757.05.000

TORTORA
verniciato tortora
47759.10.000

16,9 kg
n. pz. 1

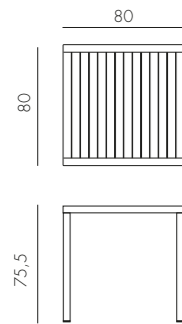

CUBE 80

durelTOP - polipropilene
alluminio

BIANCO
verniciato bianco
48053.00.000

ANTRACITE
verniciato antracite
48052.02.000

CAFFÈ
verniciato caffè
48057.05.000

TORTORA
verniciato tortora
48059.10.000

11,5 kg
n. pz. 1

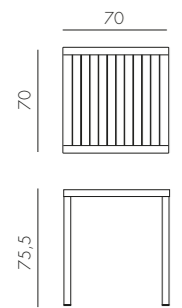

CUBE 70

durelTOP - polipropilene
alluminio

BIANCO
verniciato bianco
47853.00.000

ANTRACITE
verniciato antracite
47852.02.000

CAFFÈ
verniciato caffè
47857.05.000

TORTORA
verniciato tortora
47859.10.000

9,5 kg
n. pz. 1



* Posizionare in zona d'ombra - Only use table tops in shaded areas - Plateaux qui doivent être utilisés uniquement dans des zones ombragées -
Tischplatten nur für beschatteten Einsatzbereich - Utilizar estos tableros sólo en áreas sombreadas - Colocar em local sombreado - Gölge alana koyun -
Ставить в тени

NET TABLE 100

polipropilene fiberglass

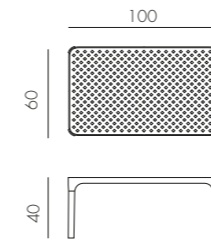

6,3 kg
n. pz. 1



BIANCO
40064.00.000

ANTRACITE
40064.02.000

SALICE
40064.04.000

TORTORA
40064.10.000

SENAPE
40064.56.000

CORALLO
40064.75.000

ARIA TAVOLINO 100

polipropilene

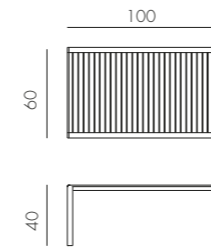

8 kg
n. pz. 1



BIANCO
40052.00.000

ANTRACITE
40052.02.000

TORTORA
40052.10.000

ARIA TAVOLINO 60

polipropilene

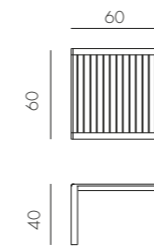

5 kg
n. pz. 1



BIANCO
40051.00.000

ANTRACITE
40051.02.000

TORTORA
40051.10.000

POP

polipropilene fiberglass

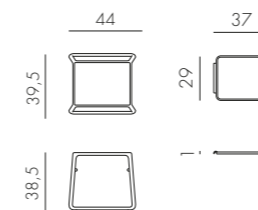

2,5 kg
n. pz. 4



BIANCO
40048.00.000

ANTRACITE
40048.02.000

CAFFÈ
40048.05.000

TORTORA
40048.10.000

CUSCINO NET BENCH

tessuto

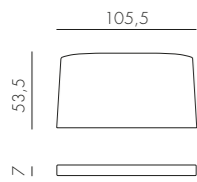
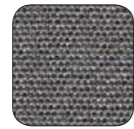
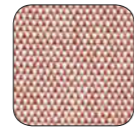
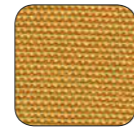
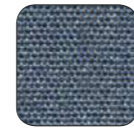
1,5 kg
n. pz. 4grey stone
36338.00.064rosa quarzo
36338.00.066senape
36338.00.069denim
36338.00.070the verde
36338.00.071sardinia
36338.00.072bianco
36338.00.155grigio
36338.00.163grigio Sunbrella®
36338.00.136

CUSCINO NET RELAX

tessuto

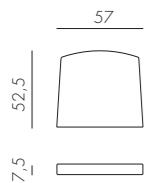
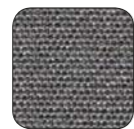
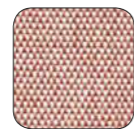
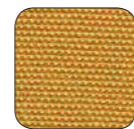
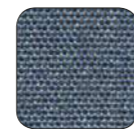
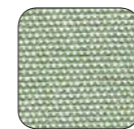
0,8 kg
n. pz. 4grey stone
36327.00.064rosa quarzo
36327.00.066senape
36327.00.069denim
36327.00.070the verde
36327.00.071sardinia
36327.00.072bianco
36327.00.155grigio
36327.00.163grigio Sunbrella®
36327.00.136

CUSCINO SHELL (NET RELAX)

tessuto

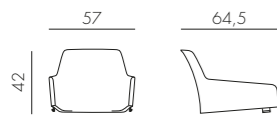
2,2 kg
n. pz. 2rosa quarzo
36327.01.066denim
36327.01.070grigio
36327.01.163

Utilizzabile solo con cuscino Net Relax - Can only be used with Net Relax cushion - À utiliser uniquement avec le coussin Net Relax - Kann nur mit Net Relax Kissen verwendet werden - Se puede utilizar sólo con el cojín Net Relax - Só pode ser usada em conjunto com almofada de assento Net Relax - Sadece Net Relax minderiyile kullanılmali - Можно использовать только с подушкой Net Relax.

CUSCINO NET

tessuto

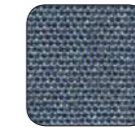
0,3 kg
n. pz. 4grey stone
36326.00.064rosa quarzo
36326.00.066senape
36326.00.069denim
36326.00.070the verde
36326.00.071sardinia
36326.00.072bianco
36326.00.155grigio
36326.00.163grigio Sunbrella®
36326.00.136

CUSCINO TRILL

tessuto

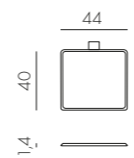
0,2 kg
n. pz. 4cenere
36253.00.132

Solo per sedia Trill Bistrot - Only for Trill Bistrot chair - Seulement pour la chaise Trill Bistrot - Nur für Trill Bistrot Stuhl - Sólo para silla Trill Bistrot - Apenas para cadeira Trill Bistrot - Sadece Trill Bistrot sandalyesi için - Только для кресла Trill Bistrot.

CUSCINO PASSEPARTOUT

tessuto

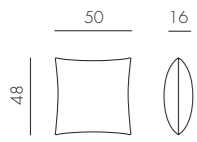

0,7 kg
n. pz. 4



grey stone
36000.01.064



rosa quarzo
36000.01.066

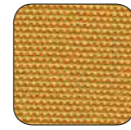

senape
36000.01.069

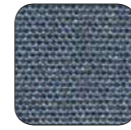

denim
36000.01.070



the verde
36000.01.071

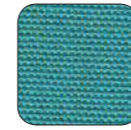

sardinia
36000.01.072



tropical
36000.01.081

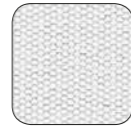

bianco
36000.01.155



grigio
36000.01.163

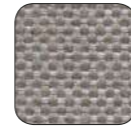

grigio Sunbrella®
36000.01.136



adriatic Sunbrella®
36000.01.142



ghiaccio Sunbrella®
36000.01.138

new

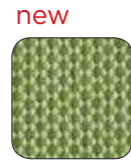

avocado Sunbrella®
36000.01.139



giungla Sunbrella®
36000.01.140

new

new

CUSCINO RETTANGOLARE **new**

tessuto

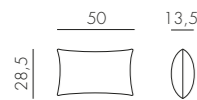

0,55 kg
n. pz. 4



rosa quarzo
36000.02.066



grigio
36000.02.163



rigato Sunbrella®
36000.02.171



adriatic Sunbrella®
36000.02.142



ghiaccio Sunbrella®
36000.02.138



avocado Sunbrella®
36000.02.139



giungla Sunbrella®
36000.02.140

materiali
materials

polipropilene

Polipropilene trattato anti-UV e colorato in massa. Riciclabile al 100%.
 Polypropylene with UV additives and is uniformly colored. 100% Recyclable resin.
 Polypropylène traité anti-UV et coloré dans la masse. Résine recyclable 100%.
 UV-beständigem Polypropylen, voll durchgefärbt. 100% Recyclebarer Kunststoff.
 Polipropileno tratado anti UV y teñido en masa. Resina reciclable 100%.
 Polipropileno com tratamento anti-UV colorido na totalidade. Resina reciclável 100%.
 Işığa dayanıklı ve boyalı olarak granül çekilmiş %100 geri dönüşümlü polipropilen kompozit hammadde.
 Полипропилен с обработкой анти-УФ, окрашенное в массе. На 100% пригодно для вторичной переработки.

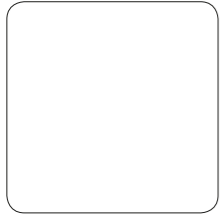

BIANCO .00



GRIGIO .03



ANTRACITE .02



TORTORA .10



TABACCO .53



CAFFE' .05



ROSA BOUQUET .08



CORALLO .75

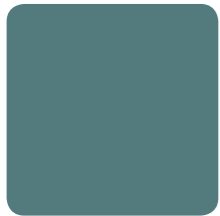

OTTANIO .49



SALICE .04



AGAVE .16



SENAPE .56

polipropilene fiberglass

Polipropilene fiberglass trattato anti-UV e colorato in massa. Resina riciclabile al 100%.
 Uniformly colored fiberglass polypropylene resins with uv additives. 100% Recyclable resin.
 Polypropylène fiberglass traité anti-uv et coloré dans la masse. Résine recyclable 100%.
 UV-beständigem fiberglass Polypropylen, voll durchgefärbt. 100% Recyclebarer Kunststoff.
 Polipropileno fiberglass tratado anti UV y teñido en masa. Resina reciclable 100%.
 Polipropileno fiberglass com tratamento anti-UV colorido na totalidade. Resina reciclável 100%.
 Işığa dayanıklı ve boyalı olarak granül çekilmiş %100 geri dönüşümlü cam elyaf katkılı polipropilen kompozit hammadde.
 Полипропилен фиброволокно с обработкой анти-УФ, окрашенное в массе. На 100% пригодно для вторичной переработки.

polipropilene fiberglass rigenerato

Polipropilene fiberglass rigenerato trattato anti-UV e colorato in massa. Resina riciclabile al 100%.
 Regenerated uniformly colored fiberglass polypropylene resins with UV additives. 100% Recyclable resin.
 Polypropylène fiberglass régénérée traité anti-UV et coloré dans la masse. Résine recyclable 100%.
 Regeneriertem UV-beständigem fiberglass-Polypropylen, voll durchgefärbt. 100% Recyclebarer Kunststoff.

Polipropileno fiberglass regenerado tratado anti-UV y teñido en masa. Resina reciclable 100%.
 Polipropileno fiberglass regenerado com tratamento anti-UV colorido na totalidade. Resina reciclável 100%.
 Uv katlı maddeleriyle fiberglass polipropilen reçine ile renklendirilip düzgün bir şekilde tekrar oluşturulmuştur.
 Переработанный, крашенный, полипропилен fiberglass обработанный против проникновения ультрафиолетовых лучей. На 100% пригодно для вторичной переработки.



TERRA .44

durelTOP

DurelTOP è un sistema innovativo di produzione di piani per tavoli studiati per raggiungere i più elevati livelli di praticità, resistenza, robustezza ed eleganza. I piani DurelTOP sono ad alto spessore, formati da un doppio strato tamburato perfettamente chiuso. Prodotti in polipropilene di prima qualità, sono inalterabili all'acqua, resistenti al sole e facili da pulire. DurelTOP è il risultato di una lunga ricerca tecnologica e dell'esperienza decennale nella lavorazione delle materie plastiche della NARDI, da sempre all'avanguardia nell'ambiente contract e giardino.

The DurelTOP is an innovative new system in the production of tabletops developed to reach the highest levels of practicality, resistance, and elegance. The DurelTOP tabletops have a greater thickness, formed by a double layer enclosure perfectly closed. Produced in first quality polypropylene, they are resistant to water, resistant to sunlight, and are easy to clean. DurelTOP is a result of a decade's long research and development in plastics by Nardi, always a leader in the contract and garden sectors.

DurelTOP est un système innovateur de production de plateaux de tables, il est étudié pour retrouver le meilleur niveau de pratique de résistance et d'élégance. Les plateaux DurelTOP sont très épais, formés de doubles couches parfaitement finies. Ce sont des produits en polypropylène de première qualité, ils sont inaltérables à l'eau, résistent au soleil et faciles à nettoyer. DurelTOP est le résultat d'une longue recherche technologique et une expérience décennale dans le travail des matières plastique de la Sté NARDI, toujours à l'avantgarde dans le secteur du contract et jardin.

DurelTOP ist ein neu entwickeltes System für die Produktion von Tischplatten, um ein Höchstmaß an Funktionalität, Widerstandsfähigkeit und Eleganz zu erreichen. Durch das innen verstärkte "Zwei-Schichten-Hohlraum-System" erreicht die DurelTOP Tischplatte einen stärkeren Querschnitt und damit ein Höchstmaß an Festigkeit. Hergestellt aus hochwertigem Qualitätspolypropylen ist sie resistent gegen Wasser und Sonnenlicht und dabei leicht zu reinigen. DurelTOP ist das Ergebnis von 10 Jahren Forschung und Entwicklung auf dem Kunststoffsektor durch Nardi, immer der führende im Bereich Contract- und Gartenmöbel.

DurelTOP es un nuevo sistema de fabricación de tableros de mesa estudiado para alcanzar los mas altos niveles de practicidad, resistencia, robustez y elegancia. Los tableros DurelTOP de gran solidez, estan formados por una doble capa perfectamente unida y sellada. Fabricados en polipropileno de primera calidad son inalterables al agua, resistentes al sol y de fácil limpieza. DurelTOP es el resultado de una prolongada investigación tecnológica y de la experiencia acumulada en los mas de diez años que Nardi lleva produciendo materias plasticas, siempre innovando en ambientes contract y jardín.

DurelTOP é um sistema de inovação da produção de tampos de mesa concebidos para atingir a máxima resistência,práticos e elegantes. Os tampos de mesa DurelTOP são formados poruma camada dupla e perfeitamente unida. Produzidos em polipropileno de primeira qualidade, são resistentes ao sol e fáceis de limpar. DurelTOP é o resultado de uma longa investigação tecnológica em materiais plásticos da Nardi, leader em mobiliário de jardim.

DurelTOP, masa tablalarının üretiminde kullanılan yeni bir sistem olup, yüksek seviyede pratiklik, direnç ve de şıklık sunmak amacıyla geliştirilmiştir. DurelTOP masa tablaları fevkalade bir inceleğe sahip olup, kusursuz kapanan çift tabaka çevirme sistemiyle oluşturulmuştur. Nitelikli çamsakızından üretilmiş olup, suya ve güneş ışığına karşı dirençli ve temizlenmesi kolaydır. DurelTOP sistemini Contract ve de Bahçe sektöründe her zaman lider olan Nardi'nin uzun araştırmalarının sonucundan doğan, plastikte gelişim olarak adlandırabiliriz.

DurelTOP — это инновационная система производства столешниц, позволяющая изготавливать практичные, прочные, крепкие и элегантные столешницы. Столешницы DurelTOP обладают высокой плотностью и состоят из двойной панели с мелкопустотным заполнением, полностью закрытой. Изделия из полипропилен высокого качества устойчивы к воде, солнцу и просты в уходе. DurelTOP — это результат многолетних технологических исследований и десятилетнего опыта NARDI в обработке пластмасс, лидера в производстве садовой мебели и контрактном секторе.



tessuto acrilico



Fibra acrilica 100% tinto filo. Trattamento antimacchia, antimuffa. Solidità alla luce 5/8. Sfoderabile/zip, lavabile a 30°.
 100% yarn dyed acrylic. Dirt repellent and anti-mould treatment. 5/8 light fastness. Removeable/zip, washable at 30°.
 100% fibre acrylique teintée en fils. Traitement anti-taches et anti-moisissure. Résistance à la lumière 5/8. Déhoussable/zip. Lavable à 30°.
 100% garngefärbtes Polyacryl Gewebe. Gegen Flecken und Schimmel Ausrüstung. Lichtechtheit 5/8. Abziehbarer/zip. Waschbar bei 30°.

100% hilo teñido acrílico. Protección antimanchas, antimoho. Solidez a la luz 5/8. Desenfundable/zip. Lavable a 30°.
 100% fibra acrílica tingida com fio. Tratamento antimancha e antimofa. Resistência à luz 5/8. Removível/zip. Lavável a 30°.
 %100 akrilik elyaf boyalı iplik. Leke itici, küf önleyici ile muamele edilmiş. Işık haslığı 5/8. Çıkarılabilir/fermuar, 30°de yıkanabilir.
 Акриловое волокно 100% окрашенное в пряде. Пятноустойчивая и противоплесневая обработка. Светостойкость 5/8. Съемная обивка/с молнией, стирать при 30°.



grigio .163
240 gr/m²



grey stone .064
240 gr/m²



the verde .071
240 gr/m²



lime .061
240 gr/m²

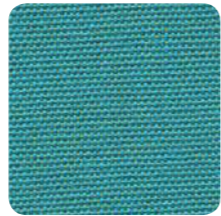

sardinia .072
240 gr/m²



denim .070
240 gr/m²



rosa quarzo .066
240 gr/m²

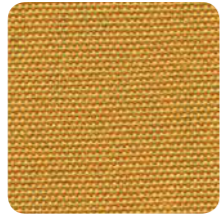

senape .069
240 gr/m²



cherry .065
240 gr/m²

tessuto acrilico stampato



Fibra acrilica 100% stampa digitale. Solidità alla luce 6. Sfoderabile/zip, lavabile a 30°.
 100% acrylic fiber with digital print. 6 light fastness. Removeable/zip, washable at 30°.
 100% fibre acrylique impression numérique. Résistance à la lumière 6. Déhoussable/zip. Lavable à 30°.
 100% Polyacrylfaser mit Digitaldruck. Lichtechtheit 6. Abziehbarer/zip. Waschbar bei 30°.

100% fibra acrílica impresión digital. Solidez a la luz 6. Desenfundable/zip. Lavable a 30°.
 100% fibra acrílica estampa digital. Resistência à luz 6. Removível/zip. Lavável a 30°.
 %100 dijital baskı akrilik elyaf. Işığa dayanıklılık 6. Çıkarılabilir kılıf/fermuar, 30°de yıkanabilir.
 100% акриловое волокно с цифровым рисунком, окрашенное в процессе производства. Светостойкость 6. Съемная ткань/на молнии, стирка при 30°.



tropical .081
190 gr/m²

tessuto acrilico Sunbrella®



100% fibra acrilica SUNBRELLA® tinto in massa. Trattamento idrorepellente, antimacchia, antimuffa. Solidità alla luce 8/8. Sfoderabile/zip, lavabile a 40°.
 100% SUNBRELLA® acrylic fiber mass dyed. Water repellent treatment, dirt repellent and anti-mould treatment. 8/8 light fastness. Removeable/zip, washable at 40°.
 100% fibre acrylique SUNBRELLA® teintée en masse. Traitement imperméable, anti-taches et anti-moisissure. Résistance à la lumière 8/8. Déhoussable/zip. Lavable à 40°.
 100% fasergefärbtes SUNBRELLA® Polyacryl. Wasserabweisend Ausrüstung, gegen Flecken und Schimmel ausgerüstet. Lichtechtheit 8/8. Abziehbarer/zip. Waschbar bei 40°.

100% fibra acrílica SUNBRELLA® tintada en masa. Tratamiento por la repelencia al agua, protección antimanchas, antimoho. Solidez a la luz 8/8. Desenfundable/zip. Lavable a 40°.
 100% fibra acrílica SUNBRELLA® tingida em massa. Tratamento hidrorrepelente, antimancha e antimofa. Resistência à luz 8/8. Removível/zip. Lavável a 40°.
 %100 akrilik elyaf SUNBRELLA® çözelti halindeyken boyanmış. Su itici, leke itici, küf önleyici ile muamele edilmiş. Işık haslığı 8/8. Çıkarılabilir/fermuar, 40°de yıkanabilir.
 100% акриловое волокно SUNBRELLA®, окрашенное в массе. Водоотталкивающая, пятноустойчивая и противоплесневая обработка. Светостойкость 8/8. Съемная обивка/с молнией, стирать при 40°.

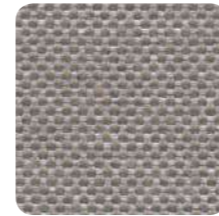

grigio Sunbrella® .136
275 gr/m²

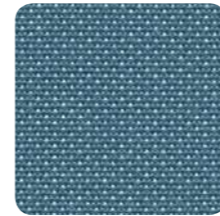

adriatic Sunbrella® .142
260 gr/m²



ghiaccio Sunbrella® .138
275 gr/m²



avocado Sunbrella® .139
260 gr/m²



giungla Sunbrella® .140 ✱
340 gr/m²

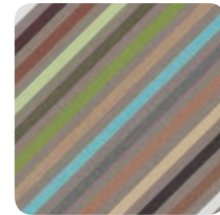

rigato Sunbrella® .171
260 gr/m²

✱ 50% fibra acrilica SUNBRELLA® riciclata tinto in massa, 47% fibra acrilica SUNBRELLA® tinto in massa, 3% poliéster.
 50% blended SUNBRELLA® acrylic fiber mass dyed, 47% SUNBRELLA® acrylic fiber mass dyed, 3% polyester.
 50% fibre acrylique SUNBRELLA® recyclée teintée en masse, 47% fibre acrylique SUNBRELLA® teintée en masse, 3% de polyester.
 50% fasergefärbtes, recyceltes SUNBRELLA® Polyacryl, 47% fasergefärbtes SUNBRELLA® Polyacryl, 3% Polyester.
 50% fibra acrílica SUNBRELLA® reciclada tintada en masa, 47% fibra acrílica SUNBRELLA® tintada en masa, 3% poliéster.
 50% fibra acrílica SUNBRELLA® reciclada tingida em massa, 47% fibra acrílica SUNBRELLA® tingida em massa, 3% de poliéster.
 %50 geri dönüştürülmüş akrilik elyaf SUNBRELLA® çözelti halindeyken boyanmış, %47 akrilik elyaf SUNBRELLA® çözelti halindeyken boyanmış, % 3 polyester.
 50% переработанное акриловое волокно SUNBRELLA®, окрашенное в массе, 47% акриловое волокно SUNBRELLA®, окрашенное в массе, 3% полиэстер.

tessuto acrilico Sunbrella® laminato



100% fibra acrilica SUNBRELLA® tinto in massa. Trattamento idrorepellente, antimacchia, antimuffa. Solidità alla luce 8/8. Accoppiato internamente con un film in poliuretano che lo rende impermeabile. Sfoderabile/zip, lavabile a 30°. La parte accoppiata in poliuretano non deve essere esposta al sole.

100% SUNBRELLA® acrylic fiber mass dyed. Water repellent treatment, dirt repellent and anti-mould treatment. 8/8 light fastness. Bonded with a polyurethane film that makes it water proof. Removeable/zip, washable at 30°. The polyurethane laminated surface should not be exposed to direct sunlight.

100% fibre acrylique SUNBRELLA® teintée en masse. Traitement imperméable, anti-taches et anti-moisissure. Résistance à la lumière 8/8. Doublé en interne avec un film de polyuréthane qui le rend imperméable. Déhoussable/zip. Lavable à 30°. La partie en polyuréthane ne doit pas être exposée au soleil.

100% fasergefärbtes SUNBRELLA® Polyacryl. Wasserabweisend Ausrüstung, gegen Flecken und Schimmel ausgerüstet. Lichtechtheit 8/8. Innen mit einer Polyurethanfolie verbunden, die es wasserdicht macht. Abziehbarer/zip. Waschbar bei 30°. Das mit Polyurethan verbundene Teil darf nicht der Sonne ausgesetzt werden.



canvas Sunbrella® laminato .170 ●
275 gr/m²

100% fibra acrilica SUNBRELLA® tintada en masa. Tratamiento por la repelencia al agua, protección antimanchas, antimoho. Solidez a la luz 8/8. Acoplado internamente con una película de poliuretano que lo hace impermeable. Desenfundable/zip. Lavable a 30°. La parte acoplada de poliuretano no debe exponerse al sol.

100% fibra acrilica SUNBRELLA® tingida em massa. Tratamento hidrorrepelente, antimancha e antimoho. Resistência à luz 8/8. Tecido dublado com filme interno de poliuretano que o torna impermeável. Removível/zip. Lavável a 30°. O lado que possui o filme de poliuretano não pode ser exposta ao sol.

%100 akrilik elyaf SUNBRELLA® çözelti halindeyken boyanmış. Su itici, leke itici, küf önleyici ile muamele edilmiş. Işık haslığı 8/8. Su geçirmemesini sağlayan dahili poliüretan film. Çıkarılabilir/fermuar, 30°de yıkanabilir. Birleştirilmiş poliüretan bölümler güneşe maruz bırakılmamalıdır.

100% акриловое волокно SUNBRELLA®, окрашенное в массе. Водоотталкивающая, пятноустойчивая и противоплесневая обработка. Светостойкость 8/8. внутри содержится полиуретановая пленка для избежания проникновения влаги. Съемная обивка/с молнией, стирать при 30°. та часть ,где имеется добавка полиуритана не выставлять на солнце.

TECH



50% vinile e 50% poliester. Trattamento idrorepellente, antimacchia, antimuffa, ignifugo e antibatterico. Solidità alla luce 6. Sfoderabile/zip. Lavare a mano in acqua fredda.

50% vinyl and 50% polyester. The treatment makes the coating: water repellent, and resistant to staining, resistant to mold, fire retardant, and antibacterial. 6 light fastness. Removeable/zip. Hand wash in cold water.

50% vinyle et 50% polyester. Traitement imperméable, anti-taches, anti-moisissures, ignifugé et antibactérien. Résistance à la lumière 6. Déhoussable/zip. Laver à la main à l'eau froide. 50% Vinyl und 50% Polyester. Wasserabweisend, gegen Flecken und Schimmelbildung ausgerüstet, feuerfest und antibakteriell. Lichtechtheit 6. Abziehbarer/zip. Handwäsche in kaltem Wasser.



TECH panama .131 ●
830 gr/m²

- Alla base dei cuscini seduta komodo canvas Sunbrella® laminato e TECH panama viene applicata una rete a maglia larga in poliester per permettere la traspirazione. At the bottom of the Komodo seat cushions, made with canvas Sunbrella® laminato and TECH panama, the fabric is a polyester wide mesh to allow breathability. À la base des coussins d'assise komodo canvas Sunbrella® laminato and TECH panama, un filet de polyester à larges mailles est appliqué pour évacuer la transpiration. Auf der Unterseite der canvas Sunbrella® laminato und TECH panama Komodo-Sitzkissen ist ein atmungsaktives Polyesterznetz mit großer Maschenweite angebracht, um Luftaustausch zu ermöglichen. En la base de los cojines de asiento del komodo canvas Sunbrella® laminato y TECH panama, se aplica una red de poliéster de malla ancha para permitir la transpiración. Na base das almofadas do assento de komodo canvas Sunbrella® laminato e TECH panama, é aplicada uma tela de poliéster de malha larga para permitir a transpiração. Hava alması için Komodo'nun altında canvas Sunbrella® laminato, TECH panama minderle, geniş fileli polyester uygulanmıştır. в основе подушек komodo ламинированный материал canvas Sunbrella и Tech panama добавлена сетка с широкой вязкой из полиэстера, чтобы материал проветривался.

tessuto 100% Olefin



100% Olefin tinto in massa. Trattamento antimacchia, antimuffa. Solidità alla luce 7/8. Sfoderabile/zip, lavabile a 40°.

100% Olefin mass dyed. Dirt repellent and anti-mould treatment. 7/8 light fastness. Removeable/zip, washable at 40°.

100% Olefin teintée en masse. Traitement anti-taches et anti-moisissure. Résistance à la lumière 7/8. Déhoussable/zip. Lavable à 40°.

100% fasergefärbtes Olefin. Gegen Flecken und Schimmel Ausrüstung. Lichtechtheit 7/8. Abziehbarer/zip. Waschbar bei 40°.

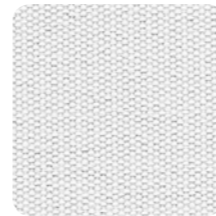

bianco .155
190 gr/m²



caffè .165
190 gr/m²

cuscino Trill termoformato



TESSUTO SUNBRELLA® TERRY: 76% fibra acrilica SUNBRELLA® tinto in massa e 24% poliester. Trattamento antimacchia, antimuffa. Solidità alla luce 7/8. Senza cuciture. Lavabile a 30°. Imbottitura: poliuretano espanso rivestito da una membrana TPU waterproof. Densità 40 kg/m³. SUNBRELLA® TERRY FABRIC: 76% SUNBRELLA® acrylic fiber mass dyed and 24% polyester. Dirt repellent and anti-mould treatment. 7/8 light fastness. Seamless. Washable at 30°. Padding: polyurethane foam with a TPU waterproof membrane coating. Density 40 kg/m³.

SUNBRELLA® TERRY TISSU :76% fibre acrylique SUNBRELLA® teintée en masse et 24% polyester. Traitement anti-taches et anti-moisissure. Résistance à la lumière 7/8. Sans couture. Lavable à 30°. Rembourrage: mousse polyuréthane revêtu d'une membrane TPU imperméable. Densité 40 kg/m³.

SUNBRELLA® TERRY GEWEBE: 76% fasergefärbtes Polyacryl SUNBRELLA® und 24% Polyester. Gegen Flecken und Schimmel Ausrüstung. Lichtechtheit 7/8. Ohne Nähte. Waschbar bei 30°. Polsterung: Polyurethanschaum mit einer wasserdichten TPU-Membran abgedeckt. Dichte 40 kg/m³.

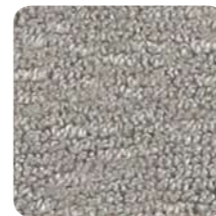

cenere .132
550 gr/m²

100% Olefin tintada en masa. Protección antimanchas, antimoho. Solidez a la luz 7/8. Desenfundable/zip. Lavable a 40°.

100% Olefin tingida em massa. Tratamento antimancha e antimoho. Resistência à luz 7/8. Removível/zip. Lavável a 40°.

%100 Olefin çözelti halindeyken boyanmış. Leke itici, küf önleyici ile muamele edilmiş. Işık haslığı 7/8. Çıkarılabilir/fermuar, 40°de yıkanabilir.

100% Olefin, окрашенный в массе. Пятноустойчивая и противоплесневая обработка. Светостойкость 7/8. Съемная обивка/с молнией, стирать при 40°.

TEJIDO SUNBRELLA® TERRY: 76% fibra acrilica SUNBRELLA® tintada en masa y 24% poliester. Protección antimanchas, antimoho. Solidez a la luz 7/8. Sin costuras. Lavable a 30°. Relleno: espuma de poliuretano recubierto con una membrana de TPU impermeable. Densidad 40 kg/m³. TECIDO SUNBRELLA® TERRY: 76% fibra acrilica SUNBRELLA® tingida em massa e 24% poliéster. Tratamento antimancha e antimoho. Resistência à luz 7/8. Sem costuras. Lavável a 30°. Enchimento: espuma de poliuretano com cobertura de membrana TPU impermeável. Densidade 40 kg/m³.

SUNBRELLA® TERRY KUVAŞ: %76 akrilik elyaf SUNBRELLA® çözelti halindeyken boyanmış ve %24 polyester. Leke itici, küf önleyici ile muamele edilmiş. Işık haslığı 7/8. Dikişsiz. 30°de yıkanabilir. Dolgu malzemesi: TPU waterproof film ile kaplanmış poliüretan köpük. Yoğunluk 40 kg/m³. ТКАНЬ SUNBRELLA® TERRY: 76% акриловое волокно SUNBRELLA®, окрашенное в массе и 24% полиэстера. Пятноустойчивая и противоплесневая обработка. Светостойкость 7/8. Без швов. Стирать при 30°. Навивка: пенополиуретан с покрытием из водостойкой мембраны ТПУ. Плотность 40 кг/м³.

imbottitura

CUSCINO NET BENCH - CUSCINO NET RELAX - CUSCINO NET - CUSCINO FIT ARIA

Poliuretano espanso. Densità 28 kg/m³. Polyurethane foam. Density 28 kg/m³. Mousse polyuréthane. Densité 28 kg/m³. Polyurethanschäum. Dichte 28 kg/m³. Espuma de poliuretano. Densidad 28 kg/m³. Espuma de poliuretano. Densidade 28 kg/m³. Poliüretan köpük. Yoğunluk 28 kg/m³. Пенополиуретан. Плотность 28 кг/м³.

CUSCINO SEDUTA ARIA

Poliuretano espanso. Densità 25 kg/m³. Polyurethane foam. Density 25 kg/m³. Mousse polyuréthane. Densité 25 kg/m³. Polyurethanschäum. Dichte 25 kg/m³. Espuma de poliuretano. Densidad 25 kg/m³. Espuma de poliuretano. Densidade 25 kg/m³. Poliüretan köpük. Yoğunluk 25 kg/m³. Пенополиуретан. Плотность 25 кг/м³.

CUSCINO SHELL NET RELAX

Poliuretano espanso su struttura rigida di polipropilene. Densità 70 kg/m³. Polyurethane foam over solid polypropylene frame. Density 70 kg/m³. Mousse polyuréthane sur structure rigide de polypropylène. Densité 70 kg/m³. Polyurethanschäum auf steifer Polypropylen-gestell. Dichte 70 kg/m³. Espuma de poliuretano sobre estructura rígida de polipropileno. Densidad 70 kg/m³. Espuma de poliuretano sobre estrutura rígida de polipropileno. Densidade 70 kg/m³. Sert polipropilen gövde üzerinde poliüretan köpük minder. Yoğunluk 70 kg/m³. Пенополиуретан на жесткой конструкции из полипропилена. Плотность 70 кг/м³.

CUSCINO PASSEPARTOUT - CUSCINO RETTANGOLARE

Fibra di poliester. Polyester fiber. Fibre de polyester. Polyesterfasern. Fibras de poliéster. Fibras de poliéster. Polyester elyaf. Обивка из полиэстера.

CUSCINO SEDUTA KOMODO - CUSCINO ARREDO ARIA

Poliuretano espanso (densità 25 kg/m³) rivestito da fibra di poliester (densità 450 gr/m²). Polyurethane foam (density 25 kg/m³) with a polyester fiber coating (density 450 gr/m²). Mousse polyuréthane (densité 25 kg/m³) revêtu de fibre de polyester (densité 450 gr/m²). Polyurethanschäum (Dichte 25 kg/m³) mit Polyesterfasern beschichtet (Dichte 450 gr/m²). Espuma de poliuretano (densidad 25 kg/m³) cubierta con fibras de poliéster (densidad 450 gr/m²). Espuma de poliuretano (densidade 25 kg/m³) com cobertura fibras de poliéster (densidade 450 gr/m²). Polyester elyaf (Yoğunluk 450 gr/m²) kaplı köpük poliüretan (Yoğunluk 25 kg/m³). Пенополиуретан (Плотность 25 кг/м³) с покрытием из обивка из полиэстера (Плотность 450 гр/м²).

CUSCINO SCHIENALE KOMODO - CUSCINO SCHIENALE ANGOLO KOMODO

Poliuretano espanso (densità 21 kg/m³) rivestito da fibra di poliester (densità 450 gr/m²). Polyurethane foam (density 21 kg/m³) with a polyester fiber coating (density 450 gr/m²). Mousse polyuréthane (densité 21 kg/m³) revêtu de fibre de polyester (densité 450 gr/m²). Polyurethanschäum (Dichte 21 kg/m³) mit Polyesterfasern beschichtet (Dichte 450 gr/m²). Espuma de poliuretano (densidad 21 kg/m³) cubierta con fibras de poliéster (densidad 450 gr/m²). Espuma de poliuretano (densidade 21 kg/m³) com cobertura fibras de poliéster (densidade 450 gr/m²). Polyester elyaf (Yoğunluk 450 gr/m²) kaplı köpük poliüretan (Yoğunluk 21 kg/m³). Пенополиуретан (Плотность 21 кг/м³) с покрытием из обивка из полиэстера (Плотность 450 гр/м²).

alluminio verniciato

La verniciatura è a polvere di poliester. The painting is with polyester powder. La peinture est à poudre de polyester. Die Epoxierung erfolgt mit Polyesterpulver.

El pintado se realiza con polvo de poliéster. O pó de poliéster é usado para envernizar. Boyası polyester tozla yapılır. Окраска производится при помощи порошкового полиэстера.



verniciato bianco .53



verniciato tortora .59



verniciato caffè .57



verniciato antracite .52

tessuto sintetico

Tessuto in filo di poliester rivestito in pvc. Fabric is made of a polyester fiber, with a pvc coating. Tissu en fil de polyester revêtu de pvc. Gewebe aus PVC-ummantelten Polyesterfasern.

Tejido en hilo de poliester recubierto de pvc. Tecido de fibra polyester com cobertura pvc. PVC kaplı polyester elyaf tekstil. Ткань из полиэфирных нитей с покрытием из ПВХ.

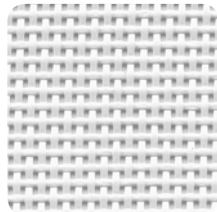

bianco .107

tela 1x1



tortora .104

tela 1x1

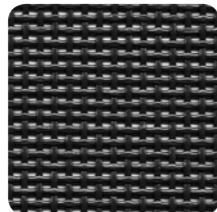

antracite .057

tela 1x1



celeste .075

tela 1x1

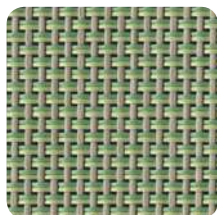

agave .101

tela 2x1

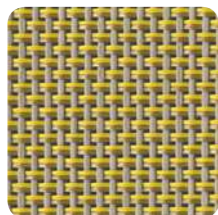

deserto .103

tela 2x1

laminato HPL

Laminato decorativo ad alta pressione, compatto, omogeneo, non poroso, ad alta densità. Decorative high pressure laminate, solid, homogeneous, non-porous and with a high density. Stratifié décoratif à haute pression, condensé, homogène, pas poreux, haute densité. HPL-Laminat, beständig, homogen, hoch verdichtet.

Laminado decorado a alta presión, compacto, homogéneo, no poroso y de alta densidad. Decorativo e laminado a alta pressão, sólido, homogêneo, não poroso e de grande densidade. Dekoratif yüksek basınçlı laminat, masif, gözeneksiz ve yüksek yoğunluklu. Декоративный ламинат высокого давления, компактный, однородный, непористый, с высокой плотностью.



BIANCO .301

sp. 12 mm



ANTRACITE .303

sp. 12 mm

vetro

Vetro float temperato serigrafato e vetrificato a 700°C. Spessore 10 mm.
Tempered Float glass, screen-printed and vitrified at 700° C. 10 mm thick.
Verre float trempé sérigraphié et vitrifié à 700°C. Epaisseur 10 mm.
Sicherheitsglas mit innenliegendem Dekorsiebdruck, verglast bei 700°. Dicke 10 mm.

Vidrio float, templado, serigrafiado y vetrificado a 700°C. Espesor 10 mm.
Vidro float temperado, impresso e vitrificado a 700°C. Espessura 10 mm.
Temperli, üstü baskılı ve 700° C vitrifiye edilmiş. Kalınlık 10 mm.
Сериграфированное закаленное стекло float, производимое при 700°C. Толщина 10 мм.



BIANCO .00



ANTRACITE .02

vetro

Vetro extrachiaro temperato. Spessore 6 mm.
Extra-clear tempered glass. 6 mm thick.
Verre trempé extra clair. Epaisseur 6 mm.
Extra klares gehärtetes Glas. Dicke 6 mm.

Vidrio templado extra claro. Espesor 6 mm.
Vidro temperado extra claro. Espessura 6 mm.
Ekstra net temperli cam. Kalınlık 6 mm.
Особо прозрачное закаленное стекло. Толщина 6 мм.



vetro .501



impilabile stackable empilable stapelbar apilable empilhável istiflenebilir стекируемые



reclinabile reclining dossier réglable verstellbare Rückenlehne reclinable reclinável sırt pozisyonlu откидной

Tutte le sedute sono dotate di piedini antiscivolo. All chairs are equipped with non-slip feet. Tous les sièges sont équipés avec patins anti-dérapants.
Alle Stühle sind mit rutschfesten Fußkappen ausgestattet. Todos los asientos están equipados con tapones antideslizantes. Todos os assentos estão equipados com pés antiderrapantes. Bütün sandalyeler kaymaz ayaklıdır. Ножки всех стульев оснащены противоскользящей резиновой подложкой.

Sui colori scuri, ombre ed altri difetti minori sono più evidenti rispetto ai colori chiari e sono da ritenersi standard. On dark colors, shadows and other minor faults are more evident than on lighter colors and are therefore standard. Sur les couleurs sombres, les ombres et les autres petits défauts sont plus marqués que sur les couleurs claires et sont tout à fait standards. Auf dunklen Farben sind Schatten und andere kleinere Mängel sichtbar als auf hellen Farben und sind daher als Standard zu betrachten. Las sombras y demás defectos menores son más evidentes sobre los colores oscuros respecto a los colores claros y tienen que considerarse como estándares. Em cores escuras, sombras e outros defeitos menores são mais evidentes do que em cores claras e devem ser considerados standard. Koyu renkler üzerinde, gölgeler ve diğer küçük defolar açık renkler üzerinde olduklarından daha belirginleşmekte ve bu nedenle normal olarak değerlendirilmelidirler. По сравнению со светлыми цветами на темных цветах тени и другие небольшие дефекты более заметны и должны считаться нормой.

Il peso (kg), le misure (cm) e i colori riportati sono indicativi. La NARDI si riserva il diritto di apportare modifiche o varianti senza preavviso. Tutti i modelli sono depositati. Weights (kg), dimensions (cm) and colors are indicative only. NARDI reserves the right to make changes or variations without notice. All models are patented. Le poids (kg), les dimensions (cm) et les coloris indiqués sont fournis purement à titre indicatif. La Firme NARDI se réserve le droit d'apporter toute modification ou variation sans aucun préavis. Tous les modèles sont déposés. Alle Farb-, Maß- (cm) und Gewichtsangaben (kg) sind nicht als fest bindend anzusehen Firma NARDI behält sich das Recht von Änderungen Alle Modelle sind gesetzlich geschützt. El peso (kg), las medidas (cm) y los colores detallados, son indicativos. La firma NARDI se reserva el derecho de modificaciones o variaciones sin previo aviso. Todos los modelos llevan nuestra marca. O peso (kg), as medidas (cm) e as cores indicadas, são indicativas. A NARDI reservase o direito de aportar modificações ou variações sem préaviso. Todos os modelos estão depositados. Ağırlık (Kg), boyutlar (cm) ve renkler gösterme amaçlıdır. NARDI'nin önceden bildirmeden değişiklik yapma hakkı vardır. Bütün modeller patentlidir. Приведенный вес (кг), размеры (см) и цвета являются ориентировочными. Компания NARDI оставляет за собой права вносить изменения и вариации без предварительного предупреждения. Все модели зарегистрированы.

Page
11-51; 59-63; 69-71; 77-81;
95-97; 103-105

STYLING
Studio Salaris

THANKS TO
Bitossi Home
Carpet Edition
Federica Bubani
Il Coccio
Les Ottomans
Mason Editions

Page
52-56; 64-67; 72-74;
82-93; 98-100

STYLING
Elisa Musso

THANKS TO
Aytm
Bitossi Home
Bloomingville
Ichendorf
Incipit Lab
L'Abitare
Normann Copenaghen

GRAPHIC DESIGN - PHOTO
Studio Raffaello Galiotto

NARDI s.p.a.
Chiampo (VI) Italy
tel. +39 0444 422100
info@nardioutdoor.com
www.nardioutdoor.com



10101101