











AR RE DO '24

TAVOLI

INDICE TAVOLI

240	ARC EN CIEL NEW METALLO	
204	BASE CLIP POLIPROPILENE FIBERGLASS	
226	BREAK ALLUMINIO VERNICIATO	
222	CALICE ALLUMINIO VERNICIATO	
264	CALICE HIGH ALLUMINIO VERNICIATO	
198	CLIP - CLIPX DURELTOP POLIPROPILENE	
274	COCKTAIL HIGH METALLO	
236	COCKTAIL METALLO	
184	COMBO POLIPROPILENE FIBERGLASS	
190	CUBO POLIPROPILENE - METALLO	

254	DARWIN NEW METALLO	
234	DIX METALLO	
232	EASY METALLO	
218	FIORE ALLUMINIO VERNICIATO	
268	FIORE HIGH ALLUMINIO VERNICIATO	
224	FLUTE ALLUMINIO VERNICIATO	
208	FRASCA ALLUMINIO VERNICIATO	
212	FRASCA FOLDING ALLUMINIO VERNICIATO	
270	FRASCA HIGH ALLUMINIO VERNICIATO	
272	FRASCA HIGH FOLDING ALLUMINIO VERNICIATO	

216	IBISCO ALLUMINIO VERNICIATO	
266	IBISCO HIGH ALLUMINIO VERNICIATO	
244	NOVA NEW METALLO	
252	PIGALLE NEW METALLO	
228	QU NEW METALLO	
258	ROUND NEW METALLO	
220	SCUDO ALLUMINIO VERNICIATO	
262	SCUDO HIGH ALLUMINIO VERNICIATO	
206	SPRITZ - STEP POLIPROPILENE FIBERGLASS	

COMBO

archiproducts
DESIGN AWARDS
2022
WINNER



Testing Certification Research

POLIPROPILENE FIBERGLASS
RIGENERATO

NARDI



TECHNICAL DETAILS

COMBO 60

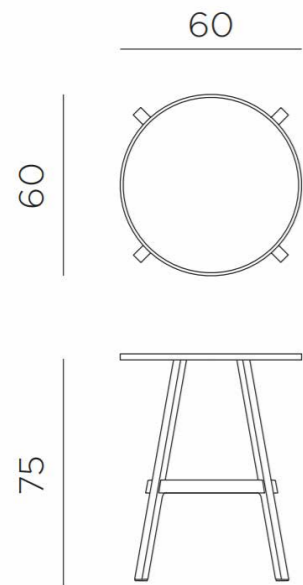

6,6 n. pz 1/12

TERRA
40030.44.000

GESSO
40030.29.000

CACTUS
40030.27.000

BASALTO
40030.25.000

COMBO 70

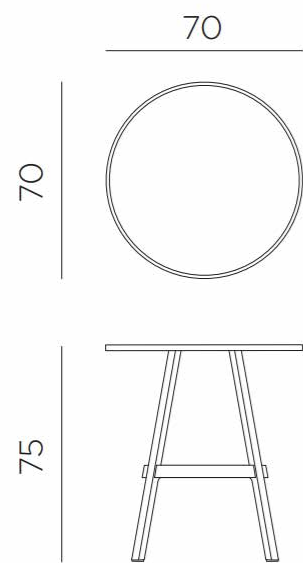

8,6 n. pz 1/6

TERRA
40032.44.000

GESSO
40032.29.000

CACTUS
40032.27.000

BASALTO
40032.25.000

TECHNICAL DETAILS

KIT COMBO HIGH

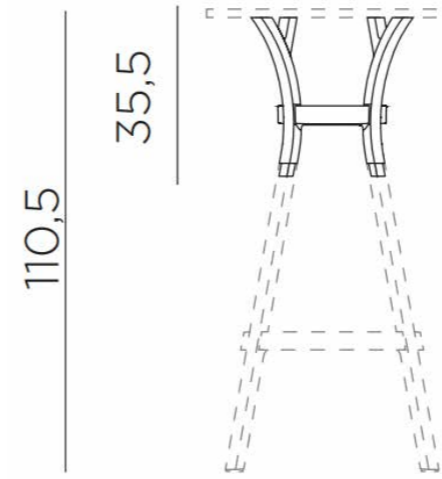

1,8 n. pz 1/30

TERRA
40031.44.000

GESSO
40031.29.000

CACTUS
40031.27.000

BASALTO
40031.25.000



CUBO

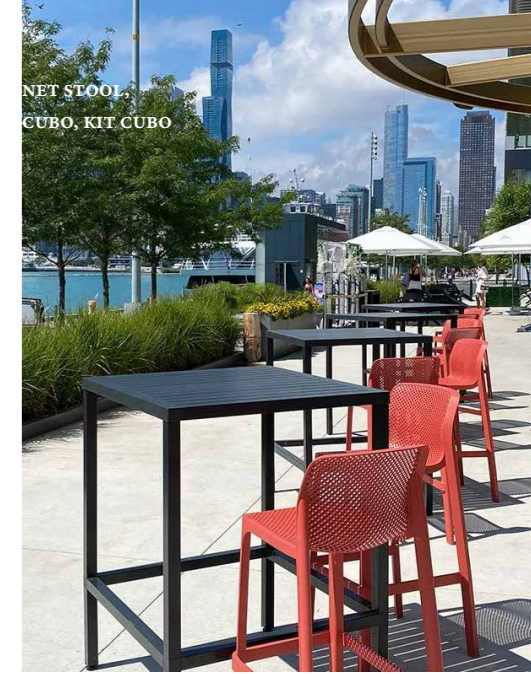

CATAS
Testing Certification Research



POLIPROPILENE FIBERGLASS
PIEDI IN METALLO

NARDI



CUBO







CUBO

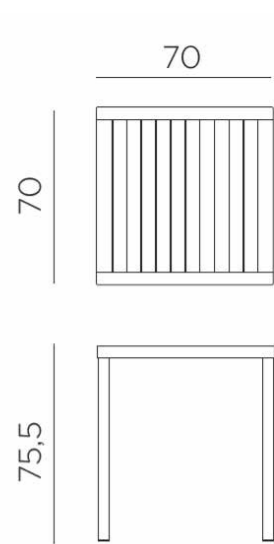

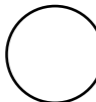

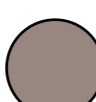

TECHNICAL DETAILS

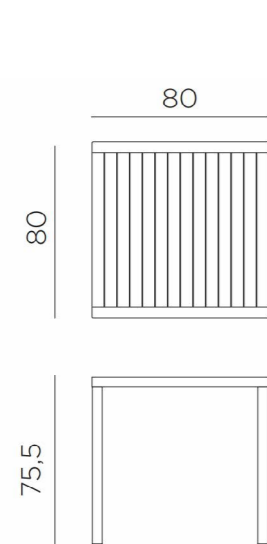

-  VERNICIATO BIANCO
47853.00.000
-  VERNICIATO ANTRACITE
47852.02.000
-  VERNICIATO TORTORA
47859.10.000
-  VERNICIATO TABACCO
47867.53.000

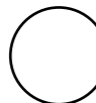
 9,5 n. pz 1/18





-  VERNICIATO BIANCO
48053.00.000
-  VERNICIATO ANTRACITE
48052.02.000
-  VERNICIATO TORTORA
48059.10.000
-  VERNICIATO TABACCO
48067.53.000

 11 n. pz 1/18

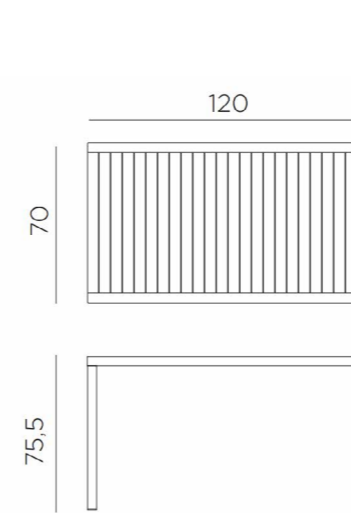



TECHNICAL DETAILS

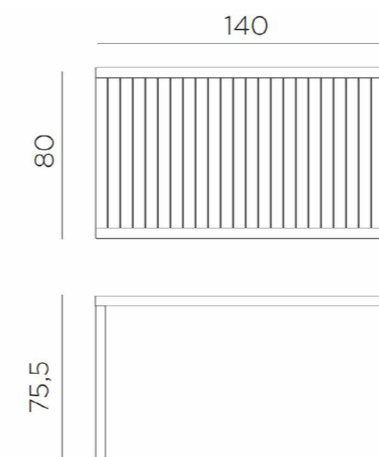

-  VERNICIATO BIANCO
47653.00.000
-  VERNICIATO ANTRACITE ~~47652.02.000~~
-  VERNICIATO TORTORA
47659.10.000
-  VERNICIATO TABACCO ~~47667.53.000~~

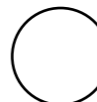
 13,3 n. pz 1/16



-  VERNICIATO BIANCO
47853.00.000
-  VERNICIATO ANTRACITE ~~47852.02.000~~
-  VERNICIATO TORTORA
47859.10.000
-  VERNICIATO TABACCO ~~47867.53.000~~

 16 n. pz 1/16

TECHNICAL DETAILS

KIT PER CUBO 70

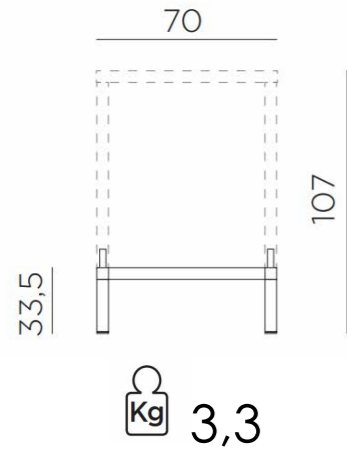

- VERNICIATO BIANCO
47953.00.000
- VERNICIATO ANTRACITE
47952.02.000
- VERNICIATO TORTORA
47959.10.000
- VERNICIATO TABACCO
47967.53.000

KIT PER CUBO 120X70

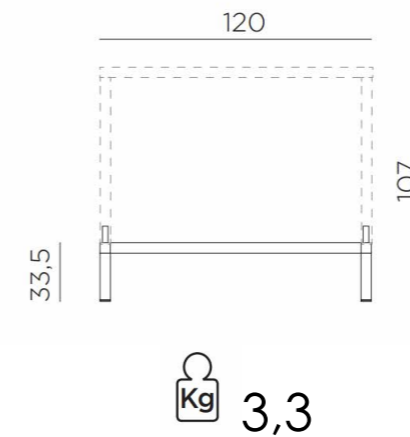

- VERNICIATO BIANCO
46853.00.000
- VERNICIATO ANTRACITE
46852.02.000
- VERNICIATO TORTORA
46859.10.000
- VERNICIATO TABACCO
46867.53.000

KIT PER CUBO 80

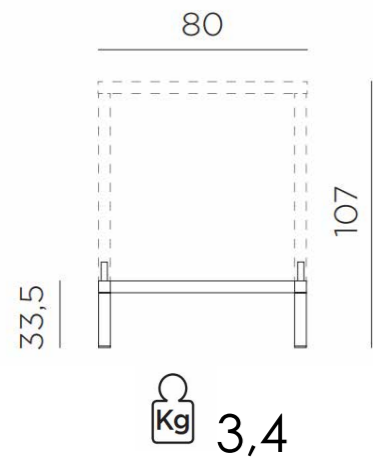

- VERNICIATO BIANCO
48153.00.000
- VERNICIATO ANTRACITE
48152.02.000
- VERNICIATO TORTORA
48159.10.000
- VERNICIATO TABACCO
48167.53.000

KIT PER CUBO 140X80

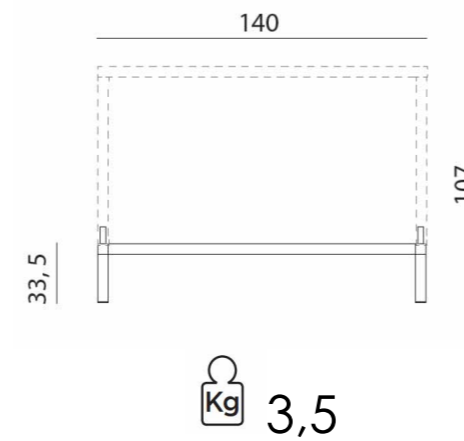

- VERNICIATO BIANCO
46953.00.000
- VERNICIATO ANTRACITE
46952.02.000
- VERNICIATO TORTORA
46959.10.000
- VERNICIATO TABACCO
46967.53.000

CLIP - CLIPX



NET, TAVOLO CLIP



CLIP, NET



NET, CLIP X

CATAS

Testing Certification Research



DURELTOP POLIPROPILENE

NARDI

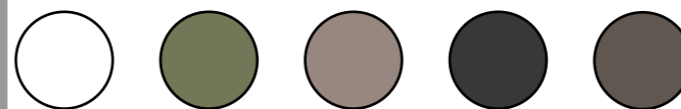

CLIP - CLIPX





CLIP - CLIPX



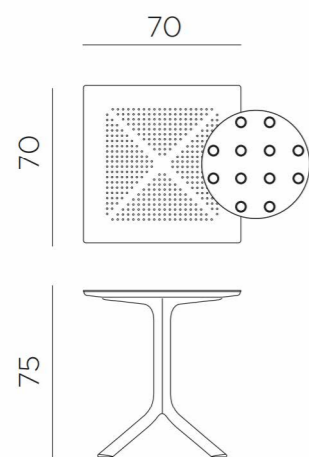

TECHNICAL DETAILS

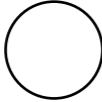
CLIP 70

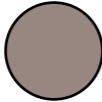



-  BIANCO
40084.00.000
 -  AGAVE
40084.16.000
 -  TORTORA
40084.10.000
-  10,5 n. pz 1/15

-  ANTRACITE ~~40084.02.000~~
-  TABACCO ~~40084.53.000~~

TECHNICAL DETAILS

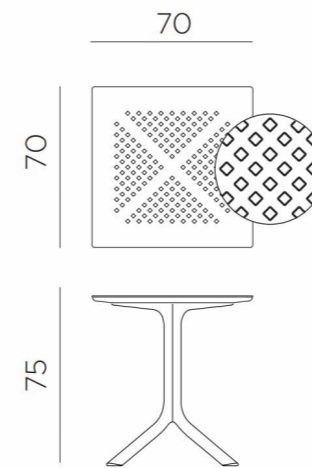
CLIPX 70

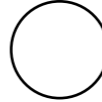
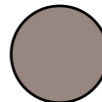

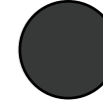

-  BIANCO
40085.00.000
 -  TORTORA
40085.10.000
-  10,4 n. pz 1/16

-  ANTRACITE ~~40085.02.000~~

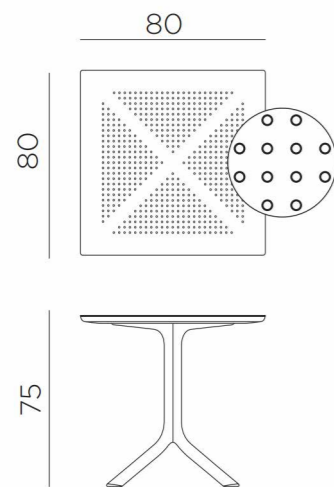
CLIP 80

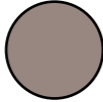



-  BIANCO
40082.00.000
 -  AGAVE
40082.16.000
 -  TORTORA
40082.10.000
-  11,8 n. pz 1/15

-  ANTRACITE ~~40082.02.000~~
-  TABACCO ~~40082.53.000~~

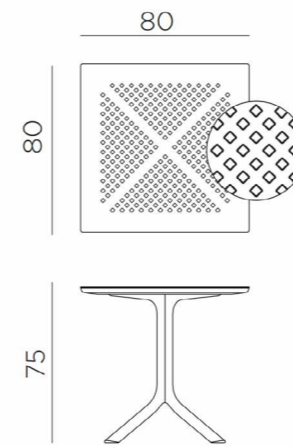
CLIPX 80

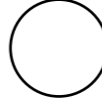
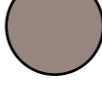

-  BIANCO
40083.00.000
 -  TORTORA
40083.10.000
-  11,4 n. pz 1/16

-  ANTRACITE ~~40083.02.000~~

BASE CLIP



Base per tavolo fisso. Materiale: polipropilene fiberglass. Dotata di piedini regolabili e di adattatore per piani: misure Ø 80 - 70 x 70 - 80 x 80 cm. Resina riciclabile.
Piani a pag. 386

TECHNICAL DETAILS

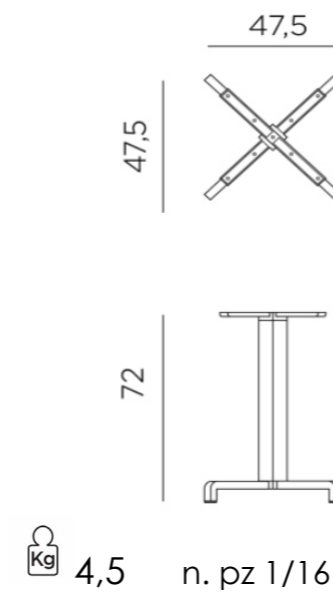

- BIANCO
40088.00.000
- AGAVE
40088.16.000
- TORTORA
40088.10.000
- ANTRACITE
40088.02.000
- TABACCO
40088.53.000

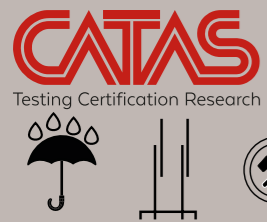

POLIPROPILENE FIBERGLASS

NARDI

STEP - SPRITZ



Tavolo con gamba centrale a 3 razze. Materiale: polipropilene fiberglass trattato anti-UV e colorato in massa. Smontabile. Finitura opaca. Dotato di piedini antiscivolo. Possibilità di doppia altezza: 40 cm / 76,5 cm. Resina riciclabile.



TECHNICAL DETAILS

STEP

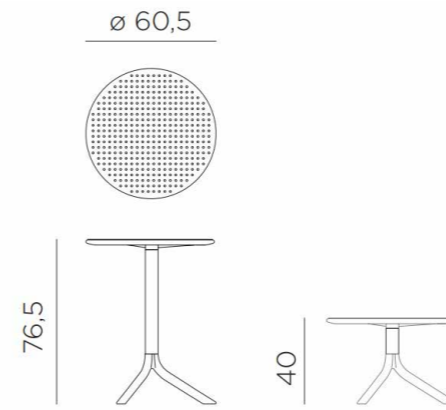

4,3 n. pz 1/24

	BIANCO 40056.00.000		TORTORA 40056.10.000
	ANTRACITE 40056.02.000		CELESTE 40056.39.000
	ROSSO 40056.07.000		AGAVE 40056.16.000

SPRITZ

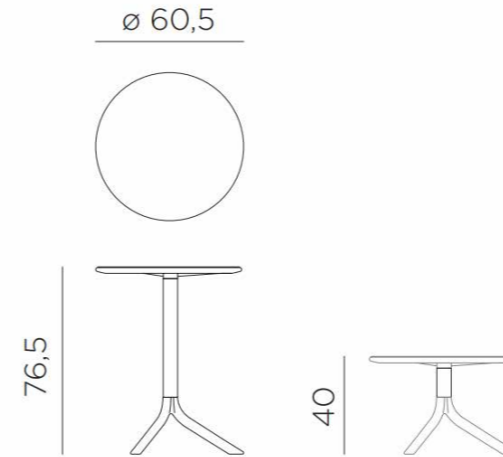

4,3 n. pz 1/24

	BIANCO 40058.00.000		TORTORA 40058.10.000
	ANTRACITE 40058.02.000		CELESTE 40058.39.000
	ROSSO 40058.07.000		AGAVE 40058.16.000



FRASCA

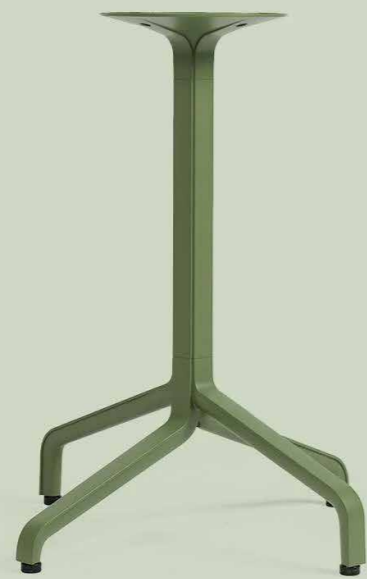

Base per tavolo fisso. Materiale: alluminio verniciato. Dotata di piedini regolabili.
Frasca Mini adatta per piani misure Ø 60 - Ø70 - Ø80 - 60 x 60 - 70 x 70 - 80 x 80 cm.
Frasca Maxi adatta per piani misure Ø 80 - Ø90 - 80 x 80 - 90 x 90 cm (Ø100 - 100x100 cm solo su richiesta).
Piani a pag. 386



ALLUMINIO VERNICIATO

NARDI

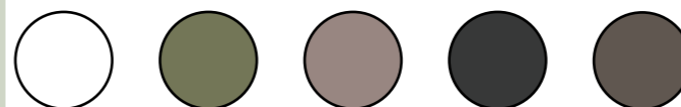

TECHNICAL DETAILS

FRASCA MINI

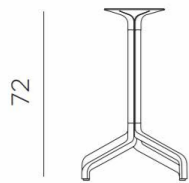
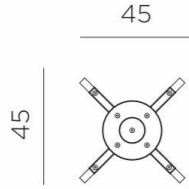

4,8 n. pz 1/32

BIANCO
53353.00.000

AGAVE
53366.00.000

TORTORA
53359.00.000

ANTRACITE
53352.00.000

TABACCO
53367.00.000

BIANCO
53353.00.000.01

AGAVE
53366.00.000.01

TORTORA
53359.00.000.01

ANTRACITE
53352.00.000.01

TABACCO
53367.00.000.01

FRASCA MAXI

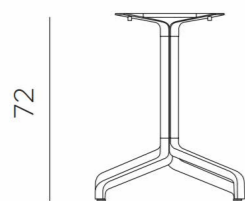
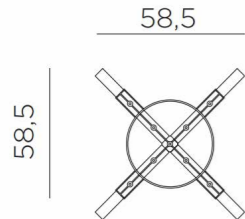

9,9 n. pz 1/32

BIANCO
53653.00.000

AGAVE
53666.00.000

TORTORA
53659.00.000

ANTRACITE
53652.00.000

TABACCO
53667.00.000

BIANCO
53653.00.000.01

AGAVE
53666.00.000.01

TORTORA
53659.00.000.01

ANTRACITE
53652.00.000.01

TABACCO
53667.00.000.01



FRASCA

FRASCA FOLDING



Base per tavolo pieghevole. Materiale: alluminio verniciato. Impilabile orizzontalmente. Dotata di piedini regolabili. Adatta per piani misure Ø 60 - Ø70 - Ø80 - 60 x 60 - 70 x 70 - 80 x 80 cm.
Piani a pag. 386

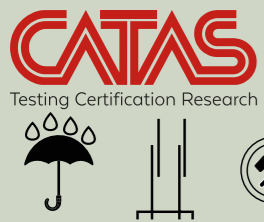

ALLUMINIO VERNICIATO

NARDI

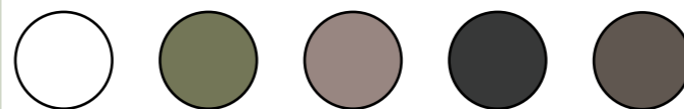

TECHNICAL DETAILS

FRASCA MINI FOLDING

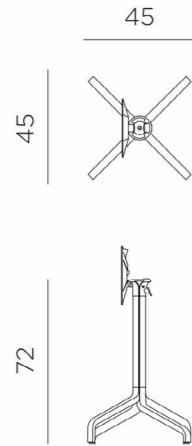

5,3 n. pz 1/32

BIANCO
53253.00.000

AGAVE
53266.00.000

TORTORA
53259.00.000

ANTRACITE
53252.00.000

TABACCO
53267.00.000

BIANCO
53253.00.000.01

AGAVE
53266.00.000.01

TORTORA
53259.00.000.01

ANTRACITE
53252.00.000.01

TABACCO
53267.00.000.01



FRASCA FOLDING

IBISCO



Base per tavolo pieghevole. Materiale: alluminio verniciato. Impilabile orizzontalmente. Dotato di piedini regolabili. Adatta per piani misure Ø 60 - Ø70 - Ø80 - 60 x 60 - 70 x 70 - 80 x 80 cm.
Piani a pag. 386

CATAS
Testing Certification Research

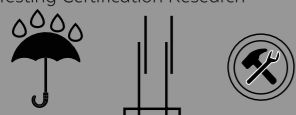

ALLUMINIO VERNICIATO

NARDI

TECHNICAL DETAILS

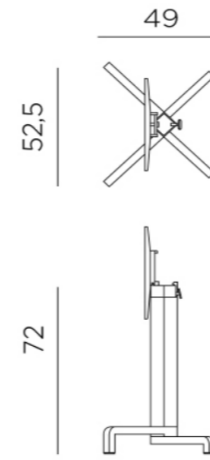

6 n. pz 1/60

- BIANCO
54553.00.000
- ARGENTO
54554.00.000
- TORTORA
54559.00.000
- ANTRACITE
54552.00.000
- TABACCO
54567.00.000

- BIANCO **AL-ST**
54553.00.000.01
- ARGENTO **AL-ST**
54554.00.000.01
- TORTORA **AL-ST**
54559.00.000.01
- ANTRACITE **AL-ST**
54552.00.000.01
- TABACCO **AL-ST**
54567.00.000.01



FIORE







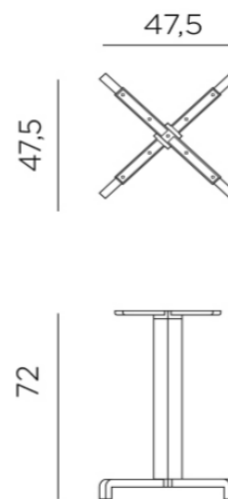

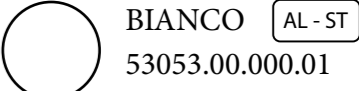

Base per tavolo fisso. Materiale: alluminio verniciato. Dotato di piedini regolabili. Adatta per piani misure Ø 60 - Ø 70 - Ø 80 - 60 x 60 - 70 x 70 - 80 x 80 cm.
Piani a pag. 386

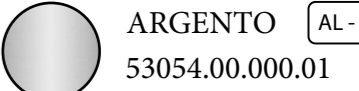
TECHNICAL DETAILS

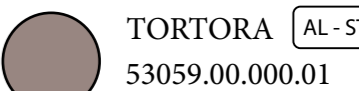

5 n. pz 1/30

 BIANCO 53053.00.000	 BIANCO AL-ST 53053.00.000.01
 ARGENTO 53054.00.000	 ARGENTO AL-ST 53054.00.000.01
 TORTORA 53059.00.000	 TORTORA AL-ST 53059.00.000.01
 ANTRACITE 53052.00.000	 ANTRACITE AL-ST 53052.00.000.01
 TABACCO 53067.00.000	 TABACCO AL-ST 53067.00.000.01

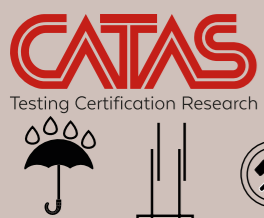

ALLUMINIO VERNICIATO

NARDI

SCUDO



Base per tavolo pieghevole. Materiale: alluminio verniciato. Impilabile orizzontalmente. Dotato di piedini regolabili. Adatta per piani misure Ø 60 - Ø70 - Ø80 - 60 x 60 - 70 x 70 - 80 x 80 cm.
Piani a pag. 386

CATAS
Testing Certification Research

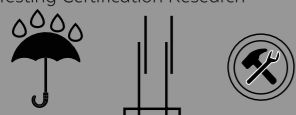

ALLUMINIO VERNICIATO

NARDI

TECHNICAL DETAILS

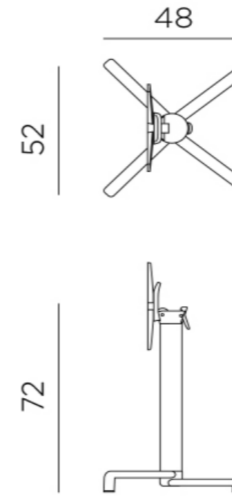

5,8 n. pz 1/60

BIANCO
54053.00.000

ARGENTO
54054.00.000

TORTORA
54059.00.000

ANTRACITE
54052.00.000

BIANCO **AL-ST**
54053.00.000.01

ARGENTO **AL-ST**
54054.00.000.01

TORTORA **AL-ST**
54059.00.000.01

ANTRACITE **AL-ST**
54052.00.000.01



CALICE



Base per tavolo fisso. Materiale: alluminio verniciato. Dotato di piedini regolabili. Adatta per piani misure Ø 60 - Ø 70 - Ø 80 - 60 x 60 - 70 x 70 - 80 x 80 cm.
Piani a pag. 386

TECHNICAL DETAILS

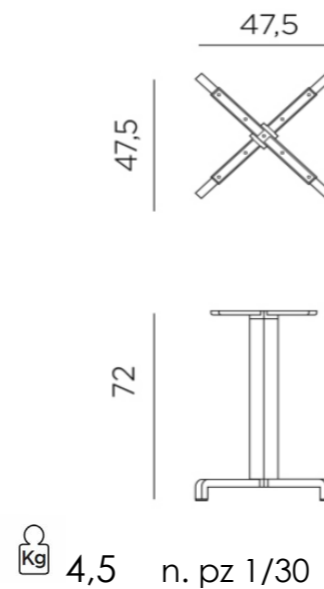

BIANCO
52653.00.000

ARGENTO
52654.00.000

TORTORA
52659.00.000

ANTRACITE
52652.00.000

BIANCO AL-ST
52653.00.000.01

ARGENTO AL-ST
52654.00.000.01

TORTORA AL-ST
52659.00.000.01

ANTRACITE AL-ST
52652.00.000.01

CATAS

Testing Certification Research



ALLUMINIO VERNICIATO

NARDI

FLUTE



Base per tavolo pieghevole. Materiale: alluminio verniciato. Impilabile orizzontalmente. Dotato di piedini regolabili. Adatta per piani Ø 60 - Ø 70 cm.
Piani a pag. 386

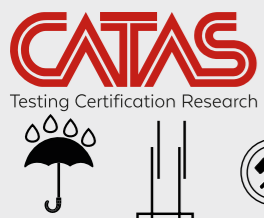

ALLUMINIO VERNICIATO

NARDI

TECHNICAL DETAILS

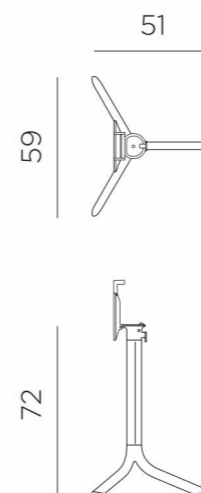

4,5 n. pz 1/16

- BIANCO
55653.00.000
- ARGENTO
55654.00.000
- TORTORA
55659.00.000
- ANTRACITE
55652.00.000

- BIANCO AL-ST
55653.00.000.01
- ARGENTO AL-ST
55654.00.000.01
- TORTORA AL-ST
55659.00.000.01
- ANTRACITE AL-ST
55652.00.000.01



BREAK



Base per tavolo fisso. Materiale: alluminio verniciato. Dotato di piedini regolabili. Adatta per piani Ø 60 - Ø 70 cm.
Piani a pag. 386

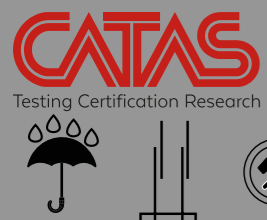

ALLUMINIO VERNICIATO

NARDI

TECHNICAL DETAILS

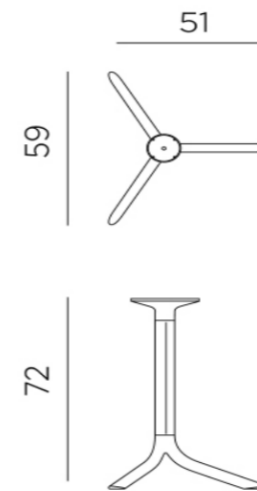

4,3 n. pz 1/32

- BIANCO
55853.00.000
- ARGENTO
55854.00.000
- TORTORA
55859.00.000
- ANTRACITE
55852.00.000

- BIANCO AL-ST
55853.00.000.01
- ARGENTO AL-ST
55854.00.000.01
- TORTORA AL-ST
55859.00.000.01
- ANTRACITE AL-ST
55852.00.000.01



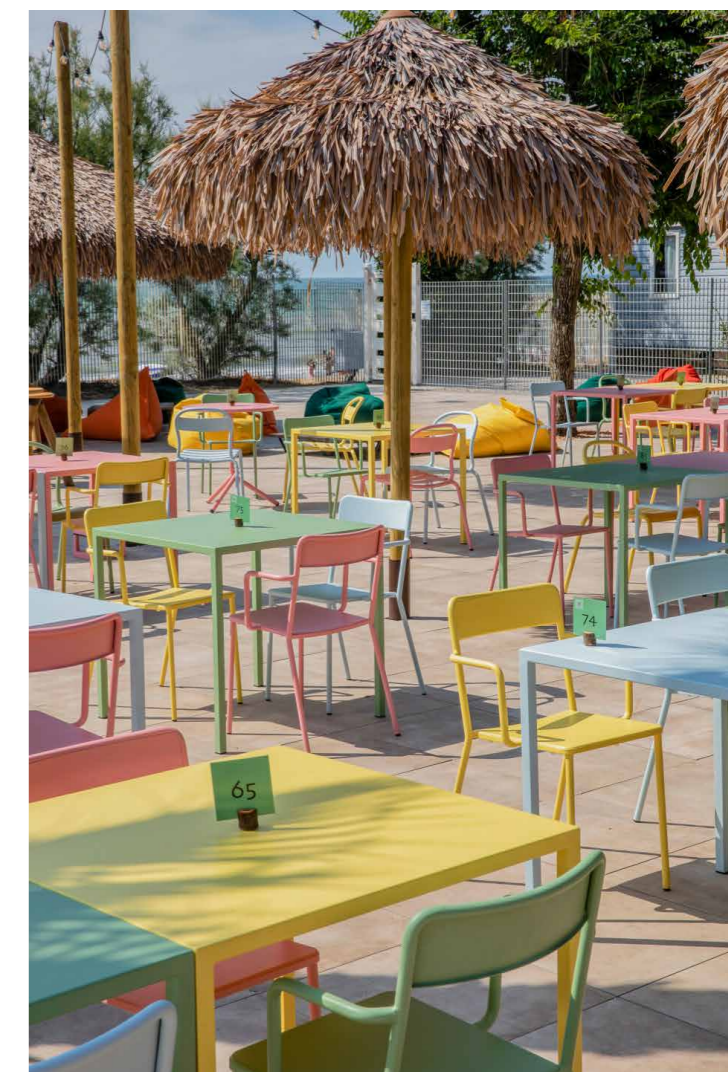
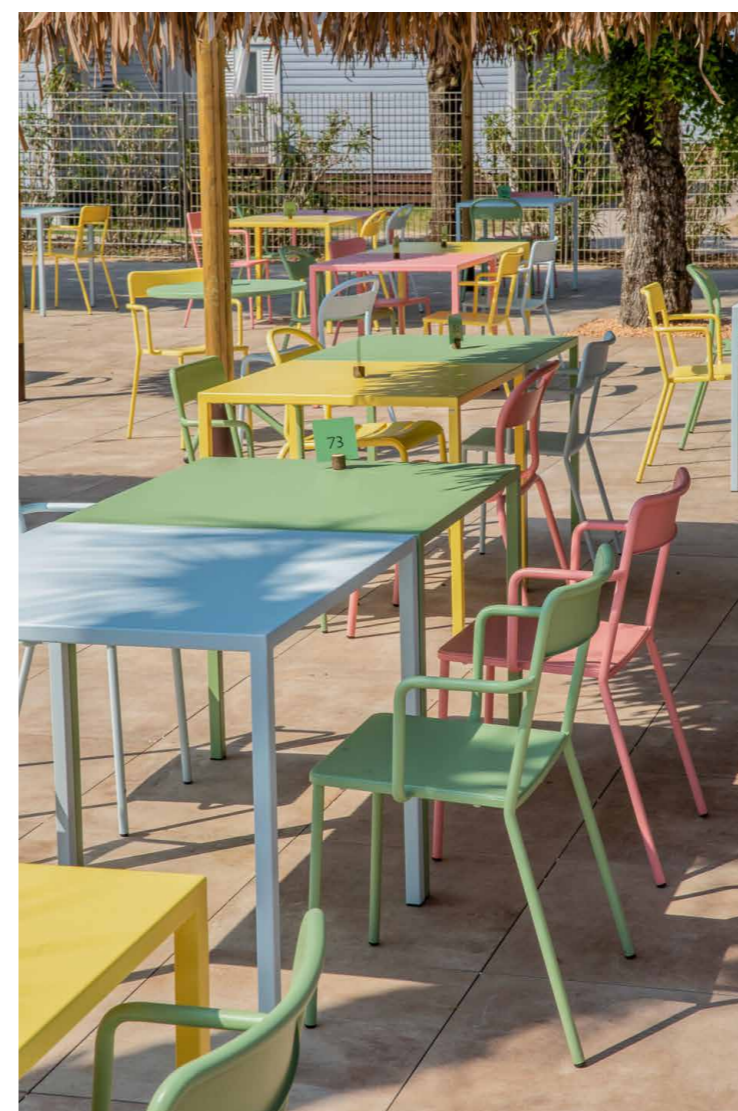

METALLO

COLOS



TECHNICAL DETAILS

QU 600

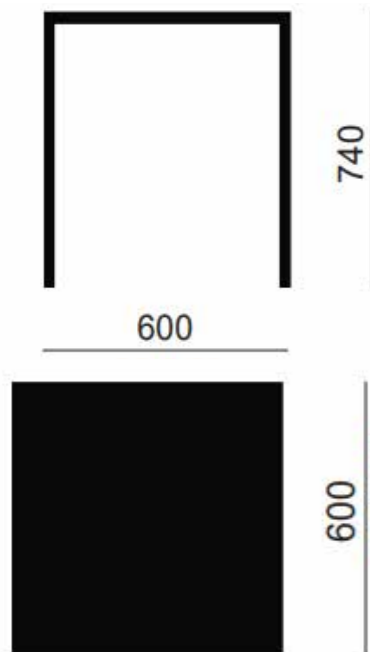

QU 700

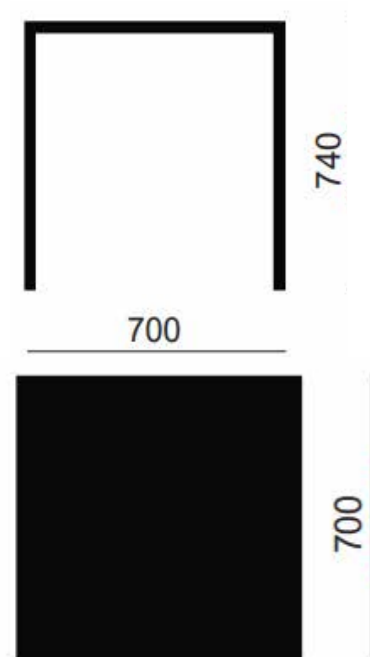

TECHNICAL DETAILS

QU 800

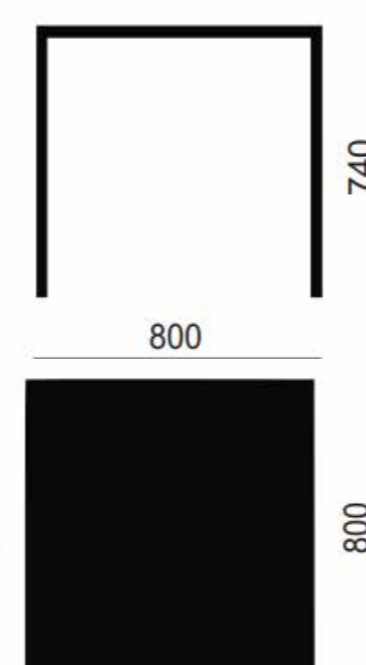

★ Per il colore SENAPE aggiungere 12 Euro al prezzo di listino

EASY



TECHNICAL DETAILS

CB4813-FD 80 E

CB4813-FQ 80 E

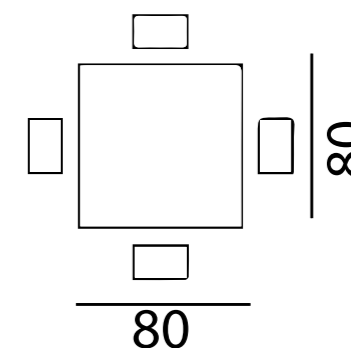
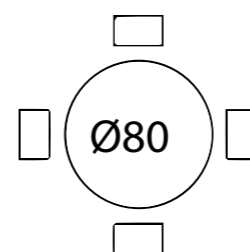
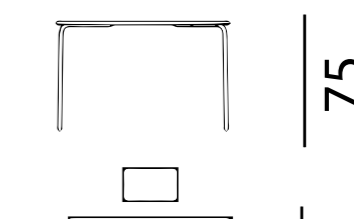
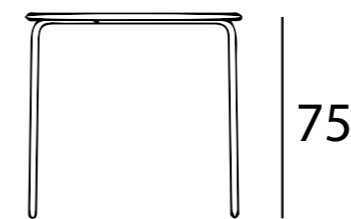

kg 25 n. pz 1

kg 25 n. pz 1



BIANCO P94



VERDE P8L

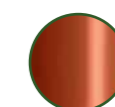

ARANCIONE P7L



GIALLO P9L



NERO P15



METALLO

connubia

DIX



TECHNICAL DETAILS

CB4804-FD E

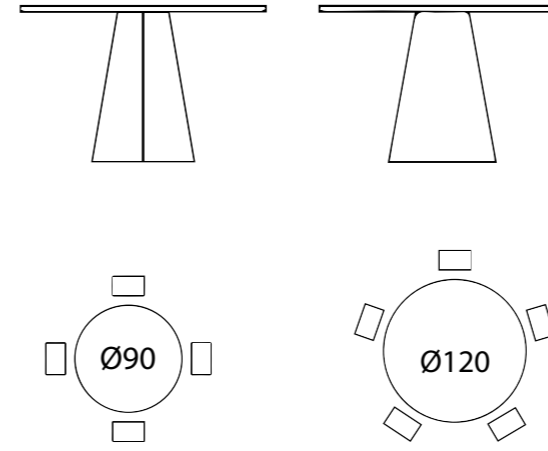

- BIANCO P94
- NERO P15
- ROSSO P3L

59 n. pz 1



METALLO

connubia

COCKTAIL



METALLO

connubia



TECHNICAL DETAILS

COCKTAIL TONDO

CB4759-B 56

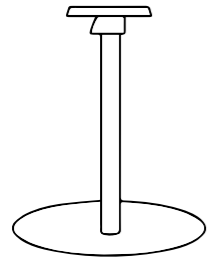

Ø56 H73 cm

15,8 - 27
n. pz 1

STRUTTURA

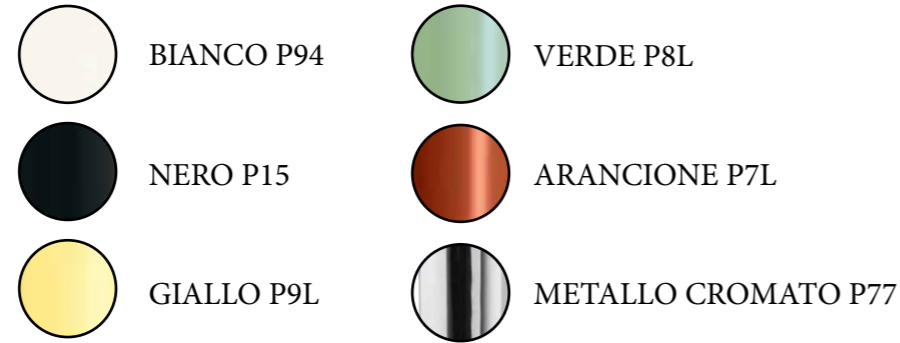

PIANO



TECHNICAL DETAILS

COCKTAIL QUADRO

CB4760-B 55

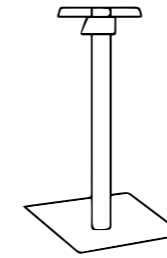

55x55 H73 cm

15,8 - 27
n. pz 1

STRUTTURA

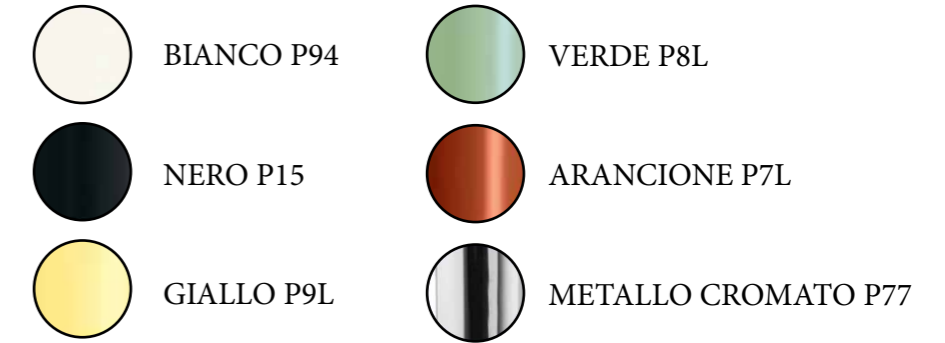

PIANO



ARC EN CIEL NEW COLLECTION



METALLO



TECHNICAL DETAILS

ARC EN CIEL 334

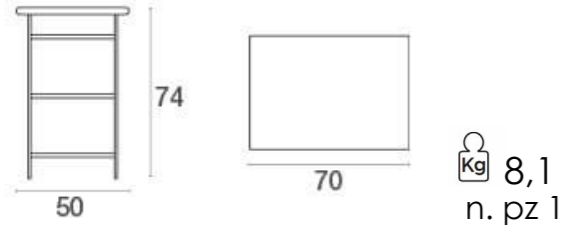

ARC EN CIEL 331



TECHNICAL DETAILS

ARC EN CIEL 346

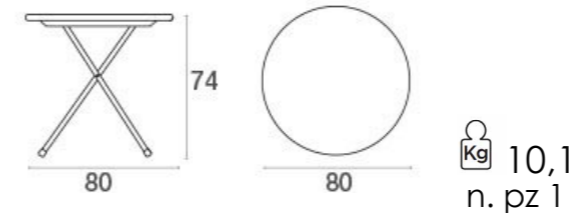

ARC EN CIEL 364

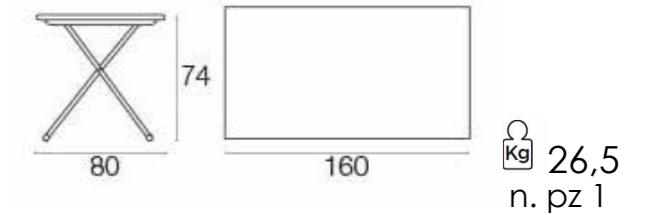

ARC EN CIEL COLLECTION

NOVA NEW COLLECTION

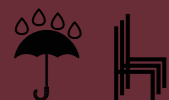

METALLO





TECHNICAL DETAILS

NOVA 858

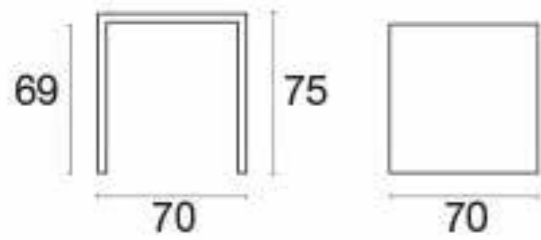

NOVA 857

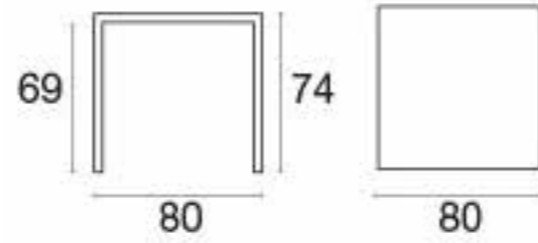

11,8 Kg
n. pz 1

14,0 Kg
n. pz 1



TECHNICAL DETAILS

NOVA854

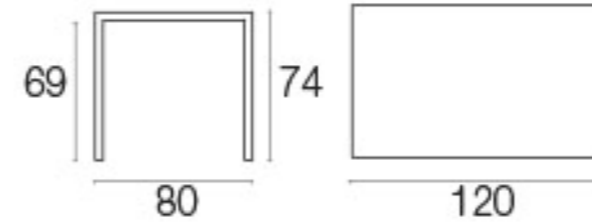

NOVA 859

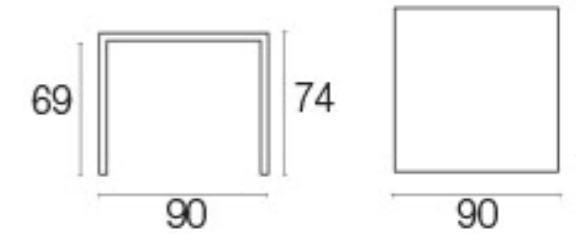

20,7 Kg
n. pz 1

18,9 Kg
n. pz 1



NOVA COLLECTION

PIGALLE NEW COLLECTION



METALLO

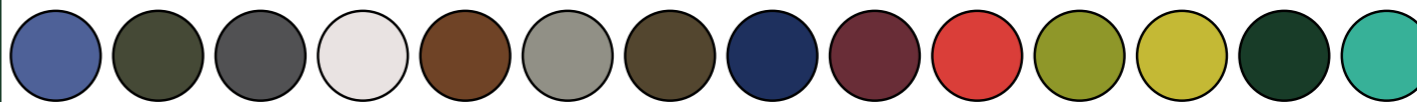

TECHNICAL DETAILS

PIGALLE 905

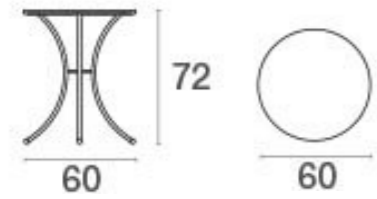

Kg 6,40
n. pz 1

PIGALLE 906

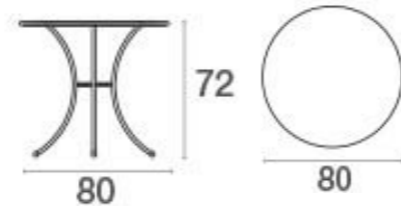

Kg 9,60
n. pz 1

- | | | |
|---|--|---|
|  AZZURRO MARINA 16 |  GRIGIO/VERDE 37 |  VERDE 60 |
|  VERDE MILITARE 17 |  MARRONE D'INDIA 41 |  GIALLO CURRY 62 |
|  FERRO ANTICO 22 |  BLU ZAFFIRO 43 |  VERDE SCURO 75 |
|  BIANCO OPACO 23 |  ROSSO INTENSO 46 |  VERDE OCEANO 88 |
|  ROSSO ACERO 26 |  ROSSO SCARLATTO 50 | |

PIGALLE COLLECTION

TECHNICAL DETAILS

 Versioni pieghevoli

PIGALLE 907

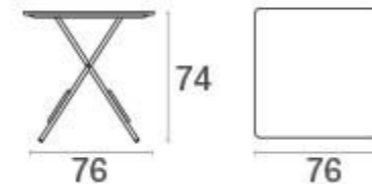

Kg 12,20
n. pz 1

PIGALLE 904

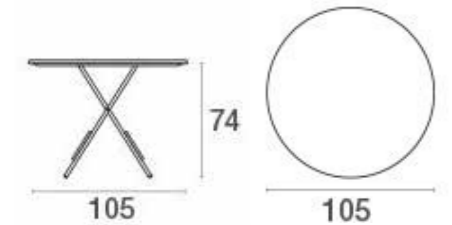

Kg 16,30
n. pz 1

PIGALLE 903

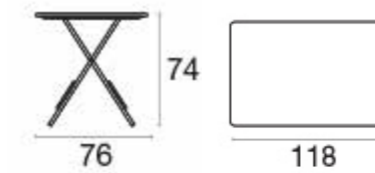

Kg 16,50
n. pz 1

- | | | |
|---|--|---|
|  AZZURRO MARINA 16 |  GRIGIO/VERDE 37 |  VERDE 60 |
|  VERDE MILITARE 17 |  MARRONE D'INDIA 41 |  GIALLO CURRY 62 |
|  FERRO ANTICO 22 |  BLU ZAFFIRO 43 |  VERDE SCURO 75 |
|  BIANCO OPACO 23 |  ROSSO INTENSO 46 |  VERDE OCEANO 88 |
|  ROSSO ACERO 26 |  ROSSO SCARLATTO 50 | |

DARWIN NEW COLLECTION



STRUTTURA METALLO
PIANO METALLO



TECHNICAL DETAILS

DARWIN 525

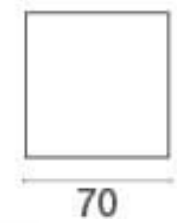
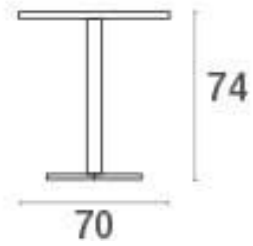

kg 14,30
n. pz 1



DARWIN 528

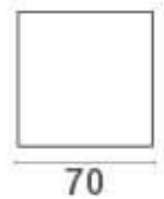
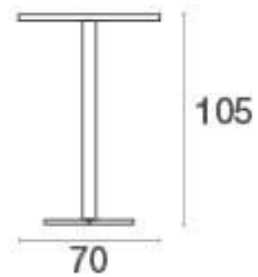

kg 15,20
n. pz 1



TECHNICAL DETAILS

DARWIN 529

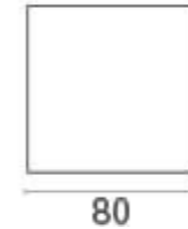
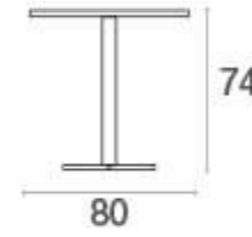

kg 16,0
n. pz 1



DARWIN 564

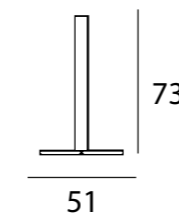

kg 7,3
n. pz 1

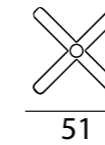

ROUND NEW COLLECTION

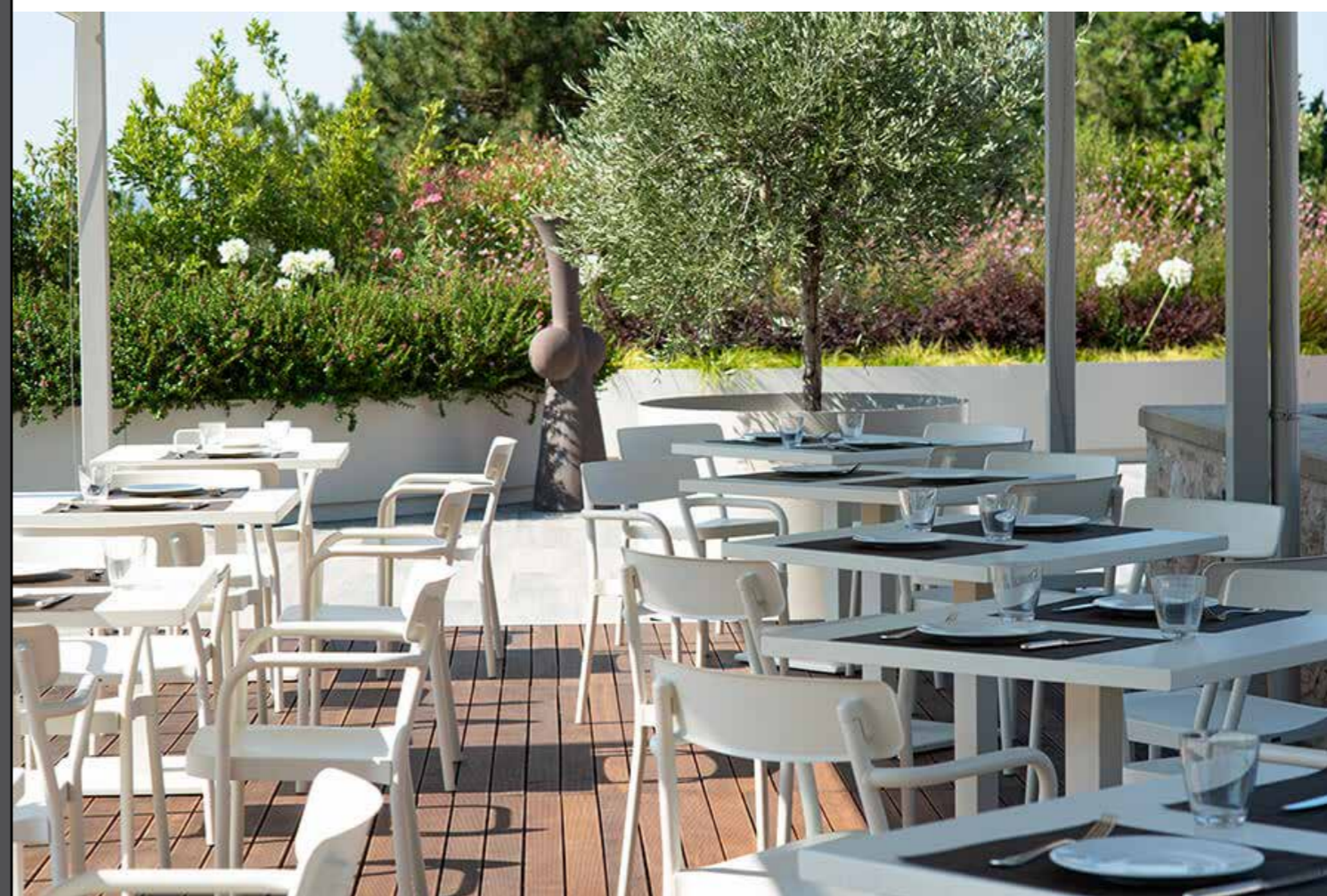

STRUTTURA METALLO
PIANO METALLO



TECHNICAL DETAILS

ROUND 472

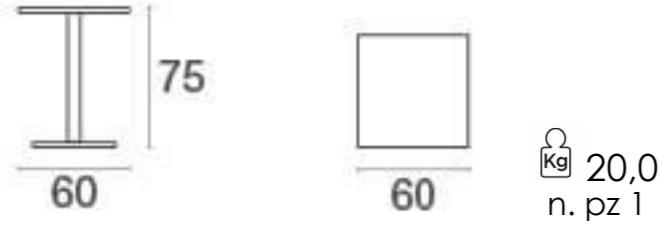

ROUND 471

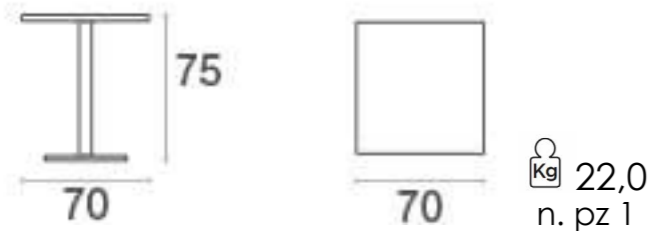

TECHNICAL DETAILS

ROUND 473

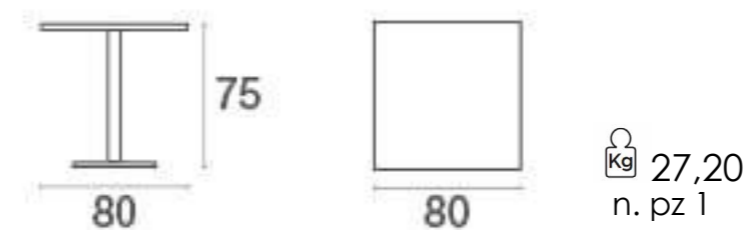

ROUND 464

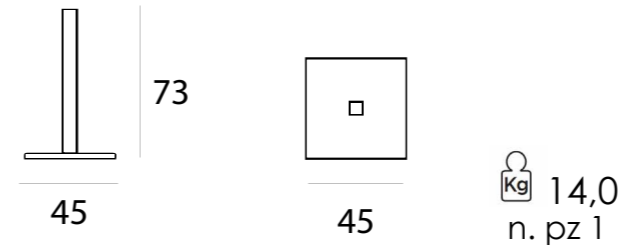

SCUDO HIGH



Base per tavolo alto pieghevole. Materiale: alluminio verniciato. Impilabile orizzontalmente. Dotato di piedini regolabili. Adatta per piani Ø 60 - Ø 70 - 60 x 60 - 70 x 70 cm.
Piani a pag. 386

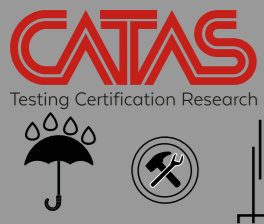

ALLUMINIO VERNICIATO

NARDI

TECHNICAL DETAILS

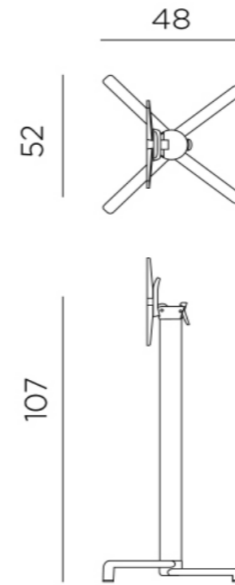

 6,7 n. pz 1/36

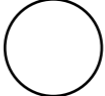
 BIANCO
54153.00.000

 ARGENTO
54154.00.000

 TORTORA
54159.00.000

 ANTRACITE
54152.00.000

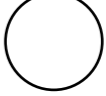
 BIANCO AL-ST
54153.00.000.01

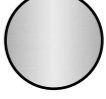
 ARGENTO AL-ST
54154.00.000.01

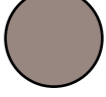
 TORTORA AL-ST
54159.00.000.01

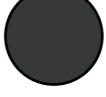
 ANTRACITE AL-ST
54152.00.000.01





CALICE HIGH



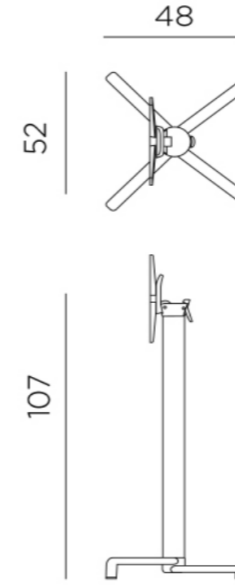

Base per tavolo alto fisso. Materiale: alluminio verniciato. Dotato di piedini regolabili. Adatta per piani Ø 60 - Ø 70 - 60 x 60 - 70 x 70 cm. Piani a pag. 386

TECHNICAL DETAILS

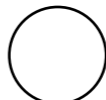
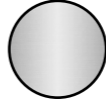

 5,5 n. pz 1/60

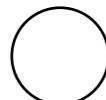
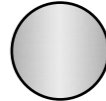
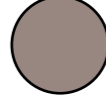
-  BIANCO
52753.00.000
-  ARGENTO
52754.00.000
-  TORTORA
52759.00.000
-  ANTRACITE
52752.00.000

-  BIANCO AL-ST
52753.00.000.01
-  ARGENTO AL-ST
52754.00.000.01
-  TORTORA AL-ST
52759.00.000.01
-  ANTRACITE AL-ST
52752.00.000.01

IBISCO HIGH

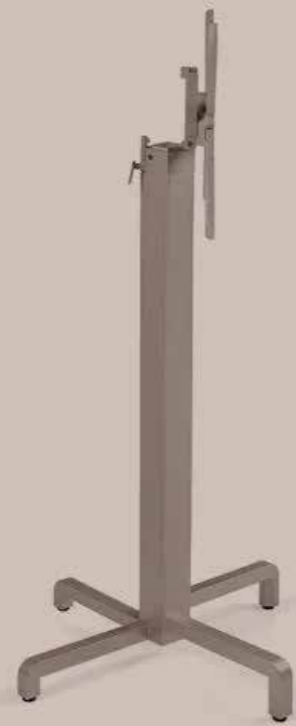

Base per tavolo alto pieghevole. Materiale: alluminio verniciato. Impilabile orizzontalmente. Dotato di piedini regolabili. Adatta per piani Ø 60 - Ø 70 - 60 x 60 - 70 x 70 cm.
Piani a pag. 386

CATAS
Testing Certification Research



ALLUMINIO VERNICIATO

NARDI

TECHNICAL DETAILS

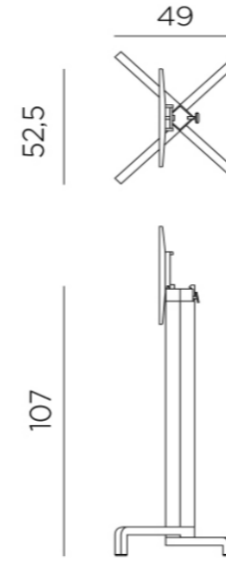

6,7 n. pz 1/36

BIANCO
54653.00.000

ARGENTO
54654.00.000

TORTORA
54659.00.000

ANTRACITE
54652.00.000

BIANCO **AL-ST**
54653.00.000.01

ARGENTO **AL-ST**
54654.00.000.01

TORTORA **AL-ST**
54659.00.000.01

ANTRACITE **AL-ST**
54652.00.000.01



FIORE HIGH

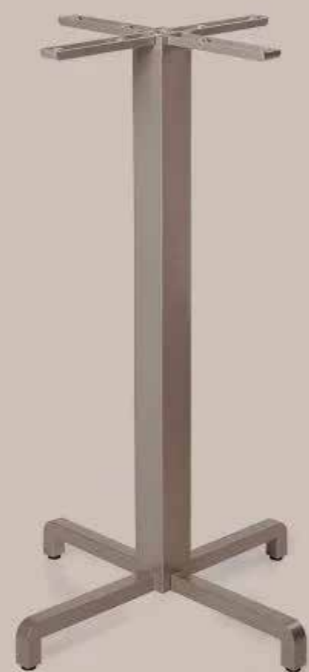

Base per tavolo alto fisso. Materiale: alluminio verniciato. Dotato di piedini regolabili. Adatta per piani Ø 60 - Ø 70 - 60 x 60 - 70 x 70 cm. Piani a pag. 386

ALLUMINIO VERNICIATO

NARDI

TECHNICAL DETAILS

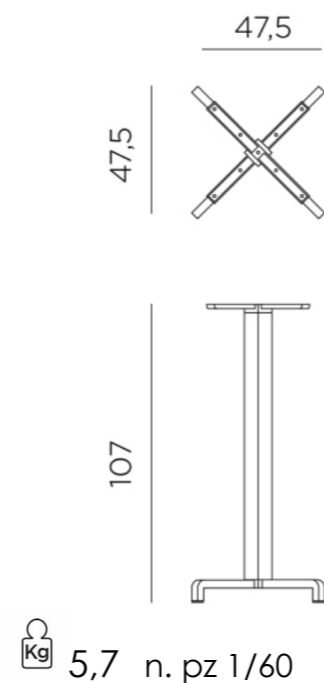

BIANCO
53153.00.000

ARGENTO
53154.00.000

TORTORA
53159.00.000

ANTRACITE
53152.00.000

TABACCO
53167.00.000

BIANCO AL-ST
53153.00.000.01

ARGENTO AL-ST
53154.00.000.01

TORTORA AL-ST
53159.00.000.01

ANTRACITE AL-ST
53153.00.000.01

TABACCO AL-ST
53167.00.000.01

FRASCA HIGH

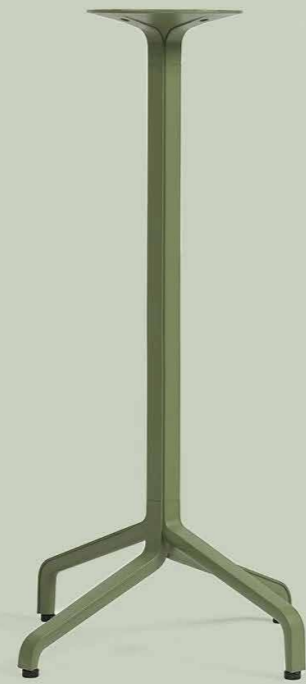

Base per tavolo alto fisso. Materiale: alluminio verniciato. Dotata di piedini regolabili. Adatta per piani misure Ø 60 - Ø70 - 60 x 60 - 70 x 70 cm.
Piani a pag. 386

ALLUMINIO VERNICIATO

NARDI

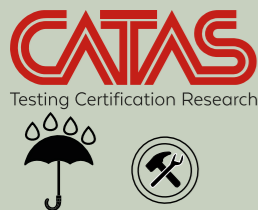

TECHNICAL DETAILS

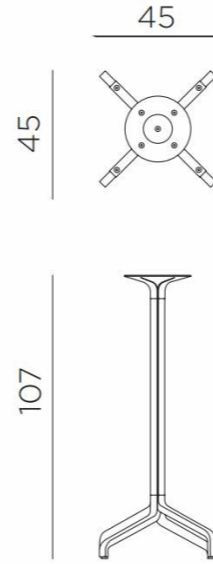

5,5 n. pz 1/32

BIANCO
53553.00.000

AGAVE
53566.00.000

TORTORA
53559.00.000

ANTRACITE
53552.00.000

TABACCO
53567.00.000

BIANCO AL-ST
53553.00.000.01

AGAVE AL-ST
53566.00.000.01

TORTORA AL-ST
53559.00.000.01

ANTRACITE AL-ST
53552.00.000.01

TABACCO AL-ST
53567.00.000.01



FRASCA HIGH FOLDING



Base per tavolo alto pieghevole. Materiale: alluminio verniciato. Impilabile orizzontalmente. Dotata di piedini regolabili. Adatta per piani misure Ø 60 - Ø70 - 60 x 60 - 70 x 70 cm.
Piani a pag. 386



ALLUMINIO VERNICIATO

NARDI

TECHNICAL DETAILS

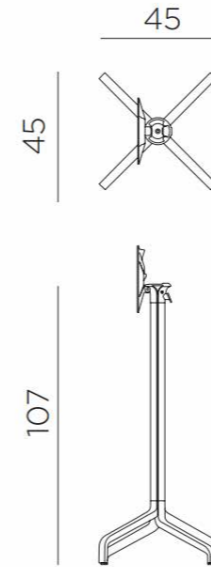

 6 n. pz 1/32

 BIANCO
53453.00.000

 AGAVE
53466.00.000

 TORTORA
53459.00.000

 ANTRACITE
53452.00.000

 TABACCO
53467.00.000

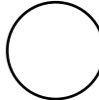
 BIANCO AL-ST
53453.00.000.01

 AGAVE AL-ST
53466.00.000.01

 TORTORA AL-ST
53459.00.000.01

 ANTRACITE AL-ST
53452.00.000.01

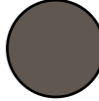
 TABACCO AL-ST
53467.00.000.01

COCKTAIL HIGH

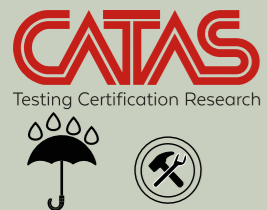

METALLO

connubia



TECHNICAL DETAILS

COCKTAIL TONDO HIGH CB4759-A 56

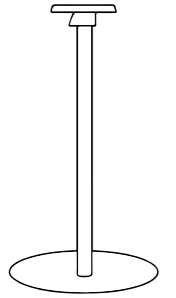

Ø56 H109

15,8 - 27
n. pz 1

STRUTTURA

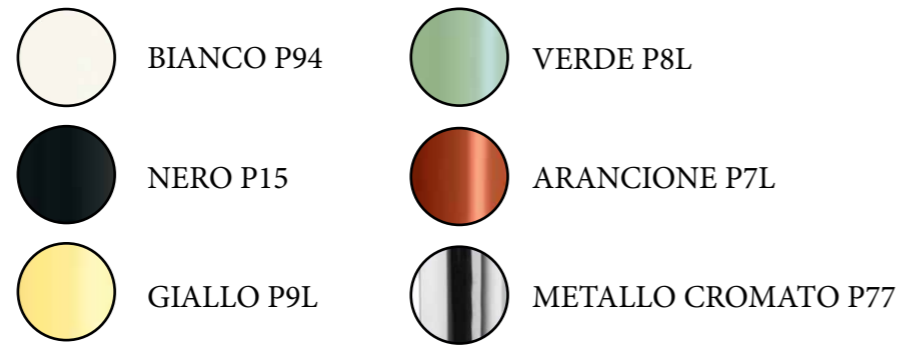

PIANO



TECHNICAL DETAILS

COCKTAIL QUADRO HIGH CB4760-A 55

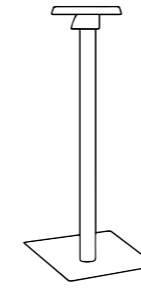

55x55 H109 cm

15,8 - 27
n. pz 1

STRUTTURA

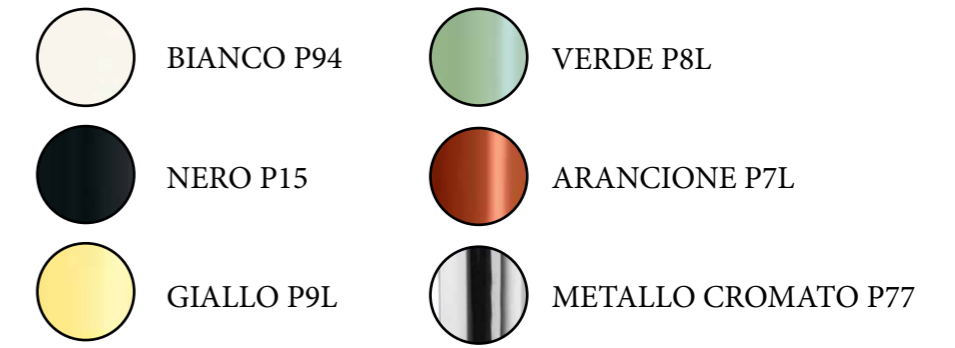

PIANO



PIANI PER BASI TAVOLO

PIANO LAMINATO -
AGAVE



.316

PIANO LAMINATO -
GRIGIO



.300

PIANO LAMINATO -
TORTORA FENIX



.318

PIANO LAMINATO -
ANTRACITE



.303

PIANO LAMINATO -
BIANCO

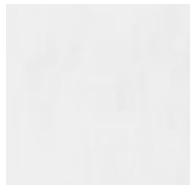

.301

PIANO LAMINATO -
TOTAL WHITE

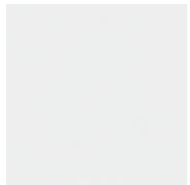

.314

PIANO LAMINATO -
NERO FENX



.313

PIANO LAMINATO -
TABACCO

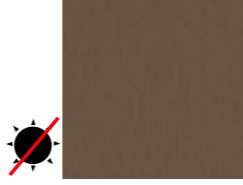

.317

PIANO LAMINATO -
CEMENTO



.305

PIANO LAMINATO -
CORTEN



.312

PIANO LAMINATO -
TORTORA



.310

PIANO LAMINATO -
LEGNO



.311

HPL LAMINATO

NARDI

PIANI PER BASI TAVOLO

PIANO LAMINATO - Ø 60



sp. 1 cm

30716.10. ...

PIANO LAMINATO - 70 x 70

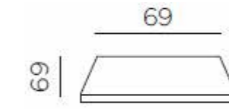

sp. 1 cm

30707.10. ...

PIANO LAMINATO - Ø 70



sp. 1 cm

30717.10. ...

PIANO LAMINATO - 80 x 80

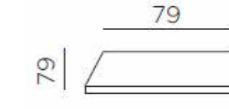

sp. 1 cm

30708.10. ...

PIANO LAMINATO - Ø 80

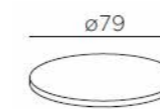

sp. 1 cm

30718.10. ...

PIANO LAMINATO - 90 x 90

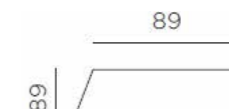

sp. 1 cm

30709.10. ...

PIANO LAMINATO - Ø 90



sp. 1 cm

30719.10. ...

PIANO LAMINATO - 110 x 70

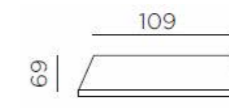

sp. 1 cm

30721.10. ...

PIANO LAMINATO - 60 x 60



sp. 1 cm

30706.10. ...

PIANO LAMINATO - 120 x 80



sp. 1 cm

30720.10. ...

Per completare il codice del piano bisogna inserire alla fine i 3 numeri

identificativi del colore

PIANI PER BASI TAVOLO

PIANO HPL - 22

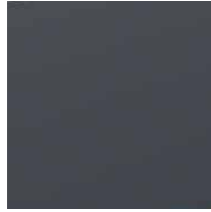

PIANO HPL - 23

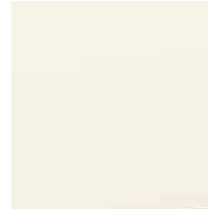

PIANO HPL - 41



PIANO HPL - 49



PIANO HPL - 54



PIANO HPL - 73



PIANO IN HPL - 69 x 69

977

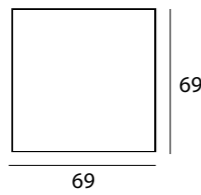

PIANO IN HPL - 79 x 79

978

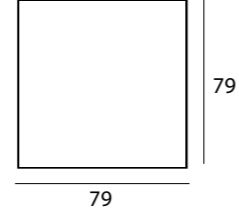

PIANI PER BASI TAVOLO

PIANO LAMINATO -
AGAVE

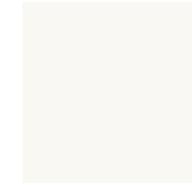

.316

PIANO LAMINATO -
GRIGIO



.300

PIANO LAMINATO -
TORTORA FENIX



.318

PIANO LAMINATO -
ANTRACITE



.303

PIANO LAMINATO -
BIANCO



.301

PIANO LAMINATO -
TOTAL WHITE

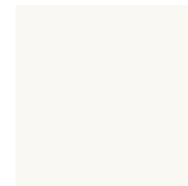

.314

PIANO LAMINATO -
NERO FENIX



.313

PIANO LAMINATO -
TABACCO



.317

PIANO LAMINATO -
CEMENTO

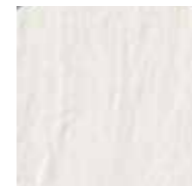

.305

PIANO LAMINATO -
CORTEX

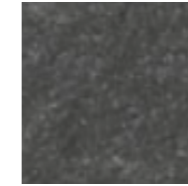

.312

PIANO LAMINATO -
TORTORA

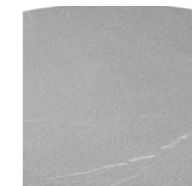

.310

PIANO LAMINATO -
LEGNO



.311

PIANO LAMINATO -
CEMENTO

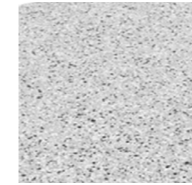

.305

PIANO LAMINATO - Ø 60

Ø59



PIANO LAMINATO - Ø 80

Ø79



PIANO LAMINATO - 60 x 60

59

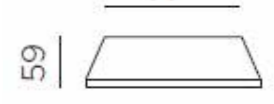

PIANO LAMINATO - 80 x 80

79

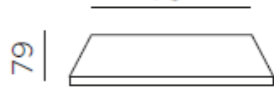

LEGENDA ICONE



Impilabile



Non impilabile

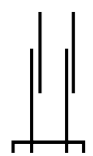

Impilabile verticalmente



Da utilizzare in zone d'ombra



Adatto all'uso in esterno



Necessario il montaggio

AL - ST

Alluminio trattato per ambienti ad alto tasso salino



Prodotto certificato CATAS



Certificazione svedese Swedish Environmental Management Council e Climate Declaration



Life Cycle Assessment. Valutazione degli impatti ambientali dei prodotti



Prodotto nuovo



Pagina con collegamenti (su foto/scritta) a video

CONDIZIONI GENERALI DI VENDITA

Con la sottoscrizione dell'ordine il Cliente accetta integralmente le condizioni generali di vendita e di consegna di seguito elencate. Le presenti condizioni determinano le regole con cui i prodotti di CM RISTO srl sono venduti e sono applicabili a tutti i contratti di vendita tra le parti. Le presenti condizioni hanno priorità su tutte le condizioni commerciali di acquisto o altri termini contrattuali contenuti nei documenti commerciali emessi dalla nostra clientela.

- 1) **Prezzi.** La merce è venduta ai prezzi in Euro in vigore all'atto dell'inserimento dell'ordine. Il Venditore si riserva il diritto di modificare in qualsiasi momento il prezzo di acquisto dei prodotti, per includervi ogni tipo di incremento dei costi delle materie prime, della produzione, delle confezioni, del trasporto o della manodopera.
- 2) **Pagamento.** Da convenirsi alla conferma dell'ordine da parte del venditore.
- 3) **Riservato dominio.** La merce rimane di proprietà di CM RISTO srl fino al pagamento integrale dell'importo dovuto dall'acquirente. In caso di inadempimento, anche parziale, del compratore, il venditore potrà richiedere la restituzione della merce e trattenere le rate pagate dal compratore a titolo di indennità, oltre al risarcimento del danno. In caso di inadempimento parziale o notevole ritardo nei pagamenti rate insolute e ritardi nei pagamenti autorizzano cm risto srl a sospendere o annullare tutti gli ordini in corso. Per tutto quanto non previsto esplicitamente, si fa riferimento a quanto stabilito dal Codice Civile.
- 4) **Trasporto.** Il metodo e il luogo di consegna devono essere convenuti all'atto dell'ordine e non possono subire modifiche dopo la conferma.
Per i trasporti diretti nelle zone di Reggio Emilia, Parma, Modena e Mantova gli ordini saranno consegnati al domicilio del Cliente a mezzo corriere convenzionato con la CM RISTO srl alle seguenti modalità:
 - Gratuitamente per ordini di importo superiore ai 150€;
 - Con addebito forfait di 5€ per importi compresi tra 150 e 50€;
 - Ordini di importo inferiore a 50€ verranno inseriti in attesa di aggiunte, potranno essere ritirati presso il deposito o consegnati con addebito totale dei costi di trasporto;
 - Gli ordini verranno consegnati secondo le tabelle di consegna di zona in possesso dei venditori. Fuori da questa programmazione verrà ritenuta come urgenza e verranno addebitati per intero i costi di trasporto sopportati.Per i trasporti attraverso differente corriere in Italia, non sarà possibile accettare "ordini tassativi" in quanto resta esclusa la responsabilità di CM RISTO srl in relazione ai tempi di consegna dei corrieri; tutta la merce viaggia in porto franco con addebito in fattura.
- 5) **Reclami.** Il cliente è tenuto a verificare l'integrità degli imballi all'atto dello scarico e di segnalarlo sul documento. La merce ricevuta, dovrà essere controllata entro 48 ore dalla consegna, non si accettano segnalazioni successive ai 7(sette) giorni lavorativi dalla data di ricezione della merce. I corrieri non sono autorizzati ad accettare resi parziali di merce all'atto dello scarico. La merce viaggia a rischio e pericolo del destinatario anche nel caso in cui la merce viaggi in porto franco. Misure e capacità sono puramente indicative. CM RISTO srl si riserva di modificare o togliere in qualsiasi momento dal proprio catalogo prodotti per motivazioni di tipo tecniche o resi non disponibili dai produttori o messi fuori assortimento senza nessun preavviso.
- 6) **Reso.** Non saranno accettati resi di articoli ordinati appositamente per il cliente. Qualsiasi richiesta di restituzione delle merci dovrà pervenire tramite i nostri Agenti o direttamente al nostro ufficio commerciale. I resi dovranno essere preventivamente autorizzati, solo dopo verifica qualitativa e quantitativa. Tutta la merce resa dovrà presentare imballo originale, etichettatura e non essere usata (il lavaggio viene considerato utilizzo).
In caso di merce erroneamente ordinata dal cliente, la segnalazione deve essere effettuata entro 7(sette) giorni dal ricevimento. La merce dovrà essere resa accompagnata da documento di trasporto. Il trasporto resta a carico del cliente. CM RISTO srl si riserva la facoltà di ritirare la merce ordinata erroneamente, trascorso il periodo di segnalazione, trattenendo una parte del valore. Non si accetta annullamento di ordini di merce richiesta dal Cliente fuori catalogo, cd. "speciale", con espressa riserva di CM RISTO srl di addebitare gli eventuali costi sostenuti.
In caso di errore di consegna da parte di CM RISTO srl, la merce potrà essere resa solo se provvista di imballo e etichette, restando valida la condizione che non sia stata utilizzata. Il ritiro sarà a carico del Venditore con i propri mezzi o corrieri.
- 7) **FORO COMPETENTE.** Per qualsiasi controversia sull'esecuzione e/o interpretazione delle presenti condizioni generali di contratto è competente esclusivamente il Foro di Reggio Emilia.